

Mobile Crane Grue mobile

LTM 1300-6.2

Technical Data
Caractéristiques techniques



LIEBHERR

Table of content Tables des matières

| Technical Data · Caractéristiques technique | |
|--|---------|
| Dimensions · Encombrement | 3 |
| Boom/jib combinations · Configurations de flèche | 4 – 6 |
| Weights, Working speeds · Poids, Vitesses | 7 |
| T | 8 – 14 |
| TK | 15 – 31 |
| TNZK | 32 – 48 |
| TF | 49 – 58 |
| TN | 59 – 75 |
| Equipment · Equipement | 76 – 77 |
| Description of symbols · Explication des symboles | 78 |
| Remarks · Remarques | 79 |

Dimensions Encombrement

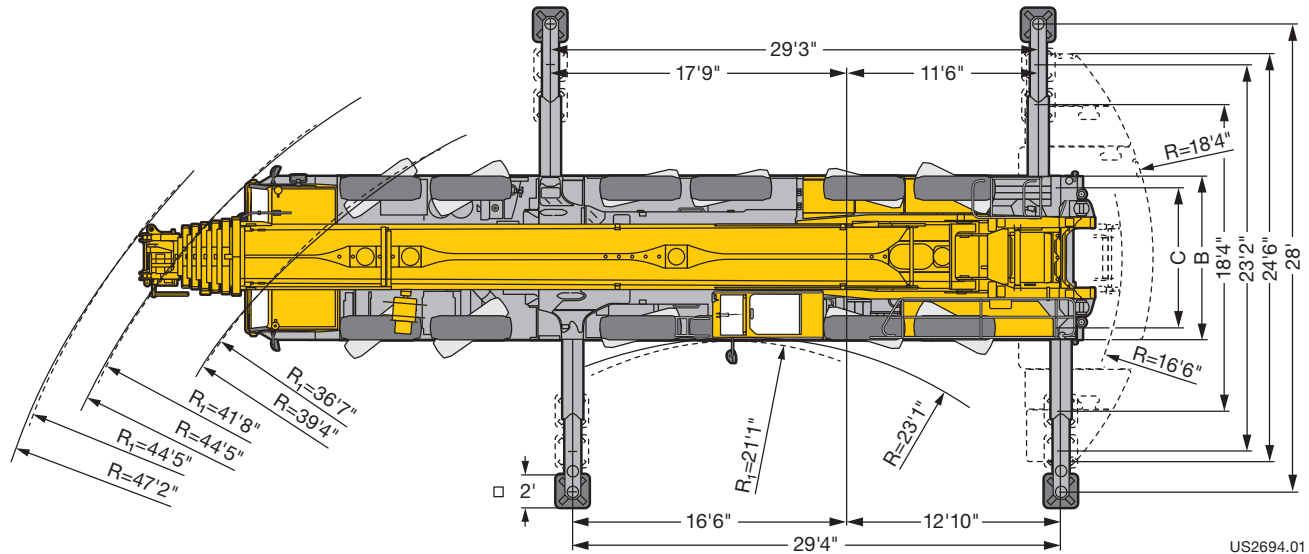
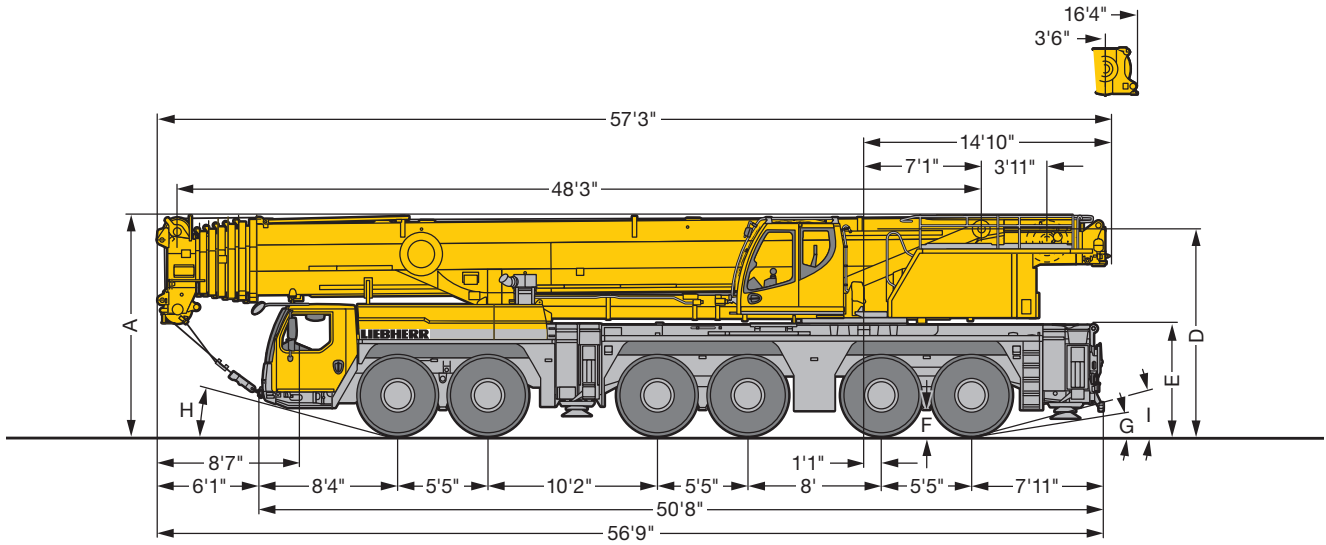

US2694.01

R_i = All-wheel steering · Direction toutes roues

| Dimensions · Encombrement | | | | | | | | | | |
|---------------------------|-------|---------|-------|------|-------|------|------|-----|----|-----|
| | A | A 5" | B | C | D | E | F | G | H | I |
| 445/95 R 25 (16.00 R 25) | 13'1" | 12'9" | 9'10" | 8'4" | 12'3" | 6'7" | 1'4" | 14° | 9° | 15° |
| 525/80 R 25 (20.5 R 25) | 13'1" | 12'9" | 10'2" | 8'5" | 12'3" | 6'7" | 1'4" | 14° | 9° | 15° |

* lowered · abaissé

Boom/jib combinations Configurations de flèche

T Telescopic boom · Flèche télescopique

K Mechanical swing away jib
Fléchette pliante mécanique

NZK Hydraulic swing away jib
Fléchette pliante hydraulique

F Fixed lattice jib · Fléchette treillis fixe

N Luffing fly jib
Fléchette treillis à volée variable



T

8 – 14

TK/TNZK

15 – 48

TF

49 – 58

TN

59 – 75



S2729

Boom/jib combinations - Luffing fly jib Configurations de flèche - Fléchette à volée variable

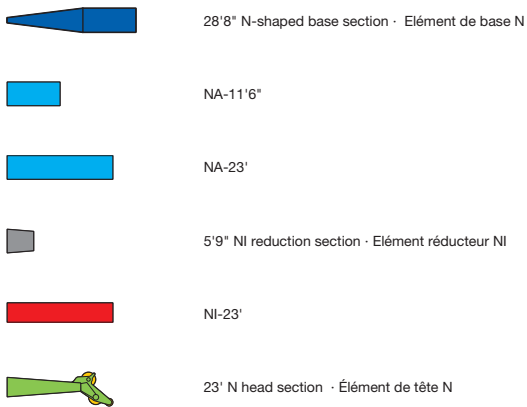
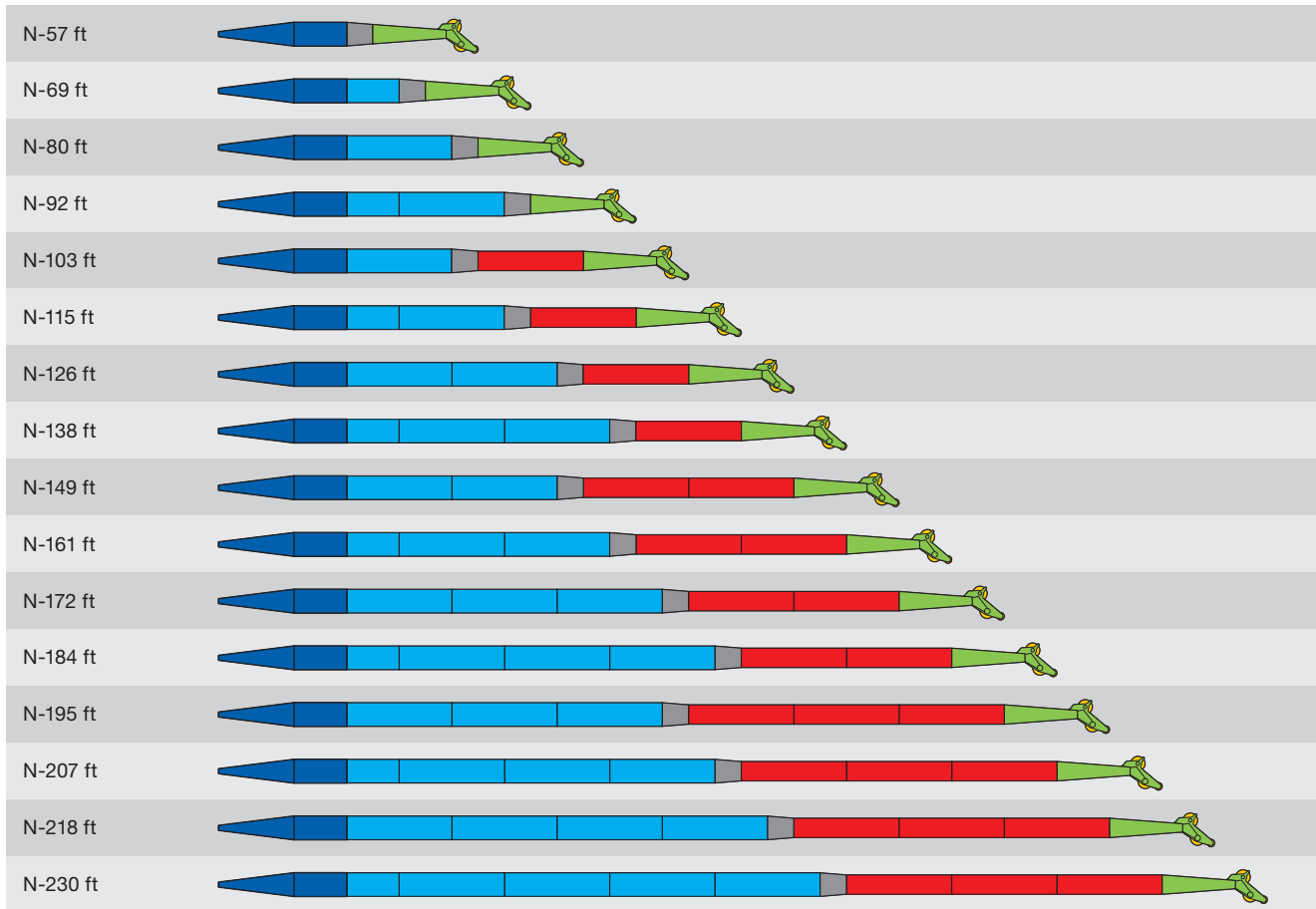

US2750

Boom/jib combinations - Fixed fly jib

Configurations de flèche - Fléchette fixe

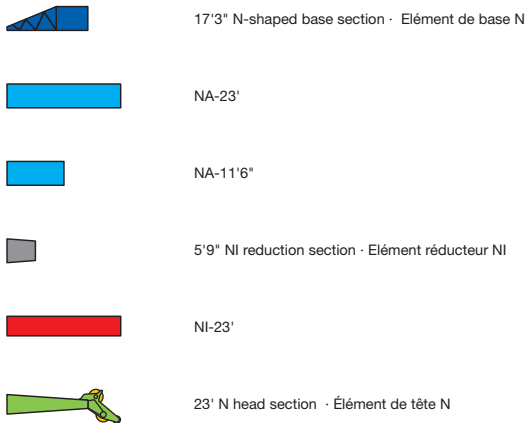
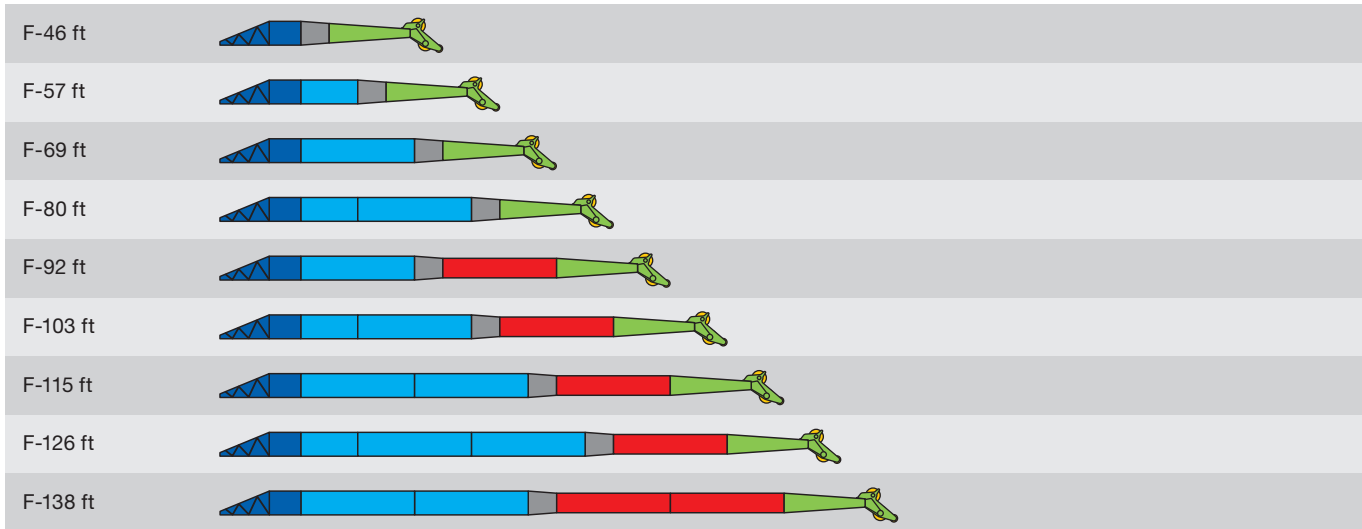

US2749

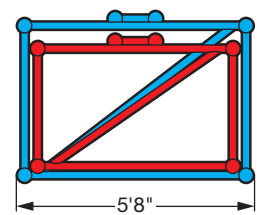
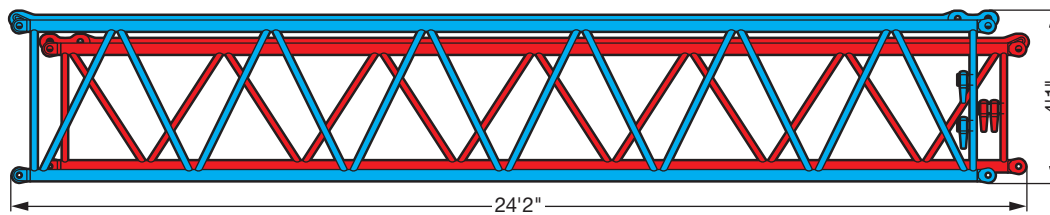

US2888

Weights Poids









| Axle Essieu | 1 | 2 | 3 | 4 | 5 | 6 | Total weight lbs Poids total lbs |
|----------------|-------|-------|-------|-------|-------|-------|-------------------------------------|
| lbs | 26400 | 26400 | 26400 | 26400 | 26400 | 26400 | 158400 |







| Load kips Forces de levage kips | No. of sheaves Poulies | No. of lines Brins | Weight lbs Poids lbs |
|------------------------------------|---------------------------|-----------------------|-------------------------|
| 403.5 | 12 | 17 | 7500 |
| 343.3 | 7 | 14 | 3300 |
| 275.6 | 5 | 11 | 3530 |
| 176.4 | 3 | 7 | 3200 |
| 79.8 | 1 | 3 | 2200 |
| 27.1 | - | 1 | 1100 |

Working speeds Vitesses



|  |  min. МИН. |  max. МАКС. |  % |   |
|---|--|---|--|---|
| 445/95 R 25 (16.00 R 25) 525/80 R 25 (20.5 R 25) | 1.3 | 50 | 50.9 % | 12 / R2 |



| Drive Mécanismes | infinitely variable en continu | Rope diameter / length Diamètre / Longueur du câble | Max. single line pull Effort au brin maxi. |
|---|--|--|---|
|  | 0 - 427 ft/min single line ft/min au brin simple | 0.9" / 984 ft | 27420 lbs |
|  | 0 - 427 ft/min single line ft/min au brin simple | 0.9" / 1525 ft | 27420 lbs |
|  | 0 - 1.6 rpm | | |
|  | approx. 80 seconds to reach 82° boom angle env. 80 s jusqu'à 82° | | |
|  | approx. 800 seconds for boom extension from 48 ft - 256 ft env. 800 s pour passer de 48 ft - 256 ft | | |

Lifting capacities Forces de levage

T



| ft | ft | | | | | | | | | | | | | | | ft | | |
|-----|-------|-------|-------|-------|--------|--------|--------|--------|--------|--------|--------|--------|--------|--------|--------|------|-----|-----|
| | 48 ft | 64 ft | 80 ft | 96 ft | 112 ft | 128 ft | 144 ft | 160 ft | 176 ft | 192 ft | 208 ft | 224 ft | 240 ft | 253 ft | 256 ft | | | |
| 10 | 661.4 | 298.6 | | | | | | | | | | | | | | 10 | | |
| 11 | 504.2 | 298.6 | 298.6 | | | | | | | | | | | | | 11 | | |
| 12 | 403.4 | 298.6 | 298.6 | 298.6 | | | | | | | | | | | | 12 | | |
| 13 | 385.2 | 298.6 | 298.6 | 298.6 | | | | | | | | | | | | 13 | | |
| 14 | 365.9 | 298.6 | 298.6 | 298.6 | | | | | | | | | | | | 14 | | |
| 15 | 349.7 | 298.6 | 298.6 | 298.6 | 248.3 | 191.2 | | | | | | | | | | 15 | | |
| 16 | 332.8 | 298.6 | 298.6 | 290.6 | 247.8 | 198.4 | | | | | | | | | | 16 | | |
| 17 | 318 | 297.3 | 296.2 | 279.6 | 246.7 | 198 | | | | | | | | | | 17 | | |
| 18 | 307.3 | 293.5 | 287.2 | 272.7 | 245.5 | 197.6 | | | | | | | | | | 18 | | |
| 19 | 297.7 | 284.4 | 278.8 | 264.2 | 244.2 | 197.1 | 159.8 | | | | | | | | | 19 | | |
| 20 | 288.4 | 274.8 | 270.9 | 256.3 | 241.9 | 196.2 | 159.3 | | | | | | | | | 20 | | |
| 22 | 271.3 | 256.4 | 257.1 | 241.9 | 230.3 | 194.3 | 158.3 | 130.2 | | | | | | | | 22 | | |
| 24 | 255 | 239.4 | 241.2 | 229.6 | 217.8 | 192.3 | 157.4 | 129.7 | | | | | | | | 24 | | |
| 26 | 235.7 | 223 | 225 | 218.6 | 206.8 | 190.4 | 156.4 | 129.2 | 102.1 | | | | | | | 26 | | |
| 28 | 218.2 | 208.6 | 210.6 | 208 | 197 | 186.8 | 155.4 | 128.6 | 101.9 | | | | | | | 28 | | |
| 30 | 202.9 | 195.8 | 197.7 | 197.6 | 188.3 | 182.4 | 154.4 | 128 | 101.6 | 82.1 | | | | | | 30 | | |
| 32 | 189.4 | 184.2 | 186.1 | 186.5 | 180.4 | 174.6 | 153.2 | 127.4 | 101.2 | 82 | | | | | | 32 | | |
| 34 | 177.5 | 173.3 | 175.3 | 175.9 | 172.7 | 167.5 | 151.9 | 126.8 | 100.9 | 81.8 | 66.1 | | | | | 34 | | |
| 36 | 166.8 | 163.6 | 165.4 | 166.1 | 165.2 | 161.1 | 150.5 | 126.1 | 100.5 | 81.5 | 65.8 | | | | | 36 | | |
| 38 | 156 | 154.6 | 156.5 | 157.2 | 156.6 | 155.1 | 147.1 | 125.1 | 99.1 | 81.1 | 65.6 | 54.1 | | | | 38 | | |
| 40 | 130.5 | 130.5 | 148 | 148.7 | 148.1 | 148.7 | 142.2 | 123.9 | 97.6 | 80.6 | 65.4 | 53.9 | | | | 40 | | |
| 45 | | | 130 | 130.1 | 132.1 | 131.7 | 129.4 | 120.6 | 92.3 | 78.6 | 64.6 | 53.4 | 43.6 | | | 45 | | |
| 50 | | | 115.9 | 117.4 | 117.5 | 116.6 | 115.2 | 114.3 | 86.4 | 75.4 | 63.3 | 52.9 | 43.3 | 36.5 | 30.3 | 50 | | |
| 55 | | | 96.1 | 105.1 | 105.2 | 104.3 | 104.9 | 104.3 | 81.2 | 71.2 | 61.2 | 52.1 | 42.5 | 36.1 | 30.1 | 29.3 | 55 | |
| 60 | | | | 94.8 | 94.8 | 93.9 | 96.1 | 94.5 | 76.2 | 67.3 | 58.4 | 50.5 | 41.5 | 35.4 | 29.9 | 29.2 | 60 | |
| 65 | | | | 85.7 | 85.7 | 84.7 | 86.9 | 85.4 | 71.5 | 63.5 | 55.5 | 48.5 | 40.4 | 34.6 | 29.4 | 28.8 | 65 | |
| 70 | | | | 74.2 | 77.9 | 78.8 | 79.1 | 77.6 | 67.3 | 59.8 | 52.8 | 46.5 | 39.1 | 33.7 | 28.8 | 28.4 | 70 | |
| 75 | | | | | 71.1 | 73.3 | 72.3 | 70.8 | 63.3 | 56.2 | 50.1 | 44.5 | 37.8 | 32.7 | 28 | 27.7 | 75 | |
| 80 | | | | | 65.3 | 67.4 | 66.4 | 64.8 | 59.6 | 53.1 | 47.5 | 42.6 | 36.5 | 31.6 | 27.1 | 26.8 | 80 | |
| 85 | | | | | 60.7 | 62.2 | 61.2 | 59.6 | 56.2 | 50.1 | 45.1 | 40.6 | 35.3 | 30.5 | 26.3 | 26 | 85 | |
| 90 | | | | | | 57.6 | 56.6 | 55 | 52.8 | 47.3 | 42.9 | 38.7 | 34 | 29.5 | 25.4 | 25.2 | 90 | |
| 95 | | | | | | 53.6 | 52.5 | 50.9 | 49.3 | 44.9 | 40.7 | 36.9 | 32.8 | 28.6 | 24.6 | 24.4 | 95 | |
| 100 | | | | | | 49.3 | 48.8 | 47.2 | 45.7 | 42.5 | 38.6 | 35.2 | 31.6 | 27.6 | 23.8 | 23.6 | 100 | |
| 105 | | | | | | 25.6 | 45.5 | 43.9 | 43.4 | 40.1 | 36.8 | 33.6 | 30.5 | 26.7 | 23 | 22.9 | 105 | |
| 110 | | | | | | | 42.5 | 40.9 | 41.9 | 38.1 | 34.9 | 32.1 | 29.3 | 25.7 | 22.3 | 22.2 | 110 | |
| 115 | | | | | | | 39.5 | 38.1 | 39.7 | 36 | 33.1 | 30.6 | 28.2 | 25 | 21.5 | 21.5 | 115 | |
| 120 | | | | | | | | 36.9 | 37.2 | 33.6 | 31.5 | 29.2 | 27.1 | 24.2 | 20.9 | 20.8 | 120 | |
| 125 | | | | | | | | 35.9 | 34.9 | 32.1 | 30.1 | 27.9 | 26 | 23.4 | 20.2 | 20.2 | 125 | |
| 130 | | | | | | | | 34.3 | 32.7 | 30.7 | 28.6 | 26.5 | 25 | 22.6 | 19.6 | 19.6 | 130 | |
| 135 | | | | | | | | 24.2 | 30.7 | 28.7 | 27.1 | 25.4 | 23.9 | 22 | 19 | 19 | 135 | |
| 140 | | | | | | | | | 28.9 | 26.9 | 25.4 | 24.2 | 22.9 | 21.3 | 18.4 | 18.4 | 140 | |
| 145 | | | | | | | | | 27 | 25.9 | 24.3 | 23.1 | 22 | 20.6 | 17.8 | 17.7 | 145 | |
| 150 | | | | | | | | | 21.8 | 25.2 | 23.3 | 22.1 | 21.1 | 20 | 17.3 | 17.1 | 150 | |
| 155 | | | | | | | | | | 24.7 | 22.4 | 21.1 | 20.2 | 19.3 | 16.7 | 16.5 | 155 | |
| 160 | | | | | | | | | | 23.4 | 21.1 | 19.8 | 19.3 | 18.6 | 16.2 | 15.8 | 160 | |
| 165 | | | | | | | | | | 18.6 | 19.8 | 19.1 | 18.5 | 17.9 | 15.6 | 15.2 | 165 | |
| 170 | | | | | | | | | | | 19.1 | 18.4 | 17.8 | 17.2 | 15.1 | 14.6 | 170 | |
| 175 | | | | | | | | | | | 18.7 | 17.8 | 16.9 | 16.5 | 14.6 | 14 | 175 | |
| 180 | | | | | | | | | | | | 15.3 | 17.1 | 16 | 15.9 | 14.2 | 180 | |
| 185 | | | | | | | | | | | | | 16.2 | 15.5 | 15.3 | 13.7 | 185 | |
| 190 | | | | | | | | | | | | | | 15.3 | 15 | 14.6 | 190 | |
| 195 | | | | | | | | | | | | | | 13.2 | 14.6 | 13.9 | 195 | |
| 200 | | | | | | | | | | | | | | | 5.4 | 14.2 | 200 | |
| 205 | | | | | | | | | | | | | | | | 13 | 205 | |
| 210 | | | | | | | | | | | | | | | | 10.3 | 210 | |
| 215 | | | | | | | | | | | | | | | | 4.7 | 215 | |
| 220 | | | | | | | | | | | | | | | | 9.9 | 220 | |
| 225 | | | | | | | | | | | | | | | | 7.2 | 225 | |
| 230 | | | | | | | | | | | | | | | | | 8.8 | 230 |
| 235 | | | | | | | | | | | | | | | | | 7.6 | 235 |
| 240 | | | | | | | | | | | | | | | | | 4.8 | 240 |





* over rear - en arrière

t_240_001_50001_00_000 / 001_50301_00_000

Lifting capacities Forces de levage

T

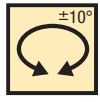
48 – 256 ft

85%

| ft | 48 ft | 64 ft | 80 ft | 96 ft | 112 ft | 128 ft | 144 ft | 160 ft | 176 ft | 192 ft | 208 ft | 224 ft | 240 ft | 253 ft | 256 ft | ft |
|-----|-------|-------|-------|-------|--------|--------|--------|--------|--------|--------|--------|--------|--------|--------|--------|-----|
| 10 | 298.6 | | | | | | | | | | | | | | | 10 |
| 11 | 298.6 | 298.6 | | | | | | | | | | | | | | 11 |
| 12 | 298.6 | 298.6 | 298.6 | | | | | | | | | | | | | 12 |
| 13 | 298.6 | 298.6 | 298.6 | | | | | | | | | | | | | 13 |
| 14 | 298.6 | 298.6 | 298.6 | | | | | | | | | | | | | 14 |
| 15 | 298.6 | 298.6 | 298.6 | 248.3 | 191.2 | | | | | | | | | | | 15 |
| 16 | 298.6 | 298.6 | 290.6 | 247.8 | 198.4 | | | | | | | | | | | 16 |
| 17 | 298.6 | 296.2 | 279.6 | 246.7 | 198 | | | | | | | | | | | 17 |
| 18 | 298.6 | 287.2 | 272.7 | 245.5 | 197.6 | | | | | | | | | | | 18 |
| 19 | 294.9 | 278.8 | 264.2 | 244.2 | 197.1 | 159.8 | | | | | | | | | | 19 |
| 20 | 288.4 | 270.9 | 256.3 | 241.9 | 196.2 | 159.3 | | | | | | | | | | 20 |
| 22 | 271.3 | 257.2 | 241.9 | 230.3 | 194.3 | 158.3 | 130.2 | | | | | | | | | 22 |
| 24 | 255 | 242.8 | 229.6 | 217.8 | 192.3 | 157.4 | 129.7 | | | | | | | | | 24 |
| 26 | 235.7 | 230.1 | 218.6 | 206.8 | 190.4 | 156.4 | 129.2 | 102.1 | | | | | | | | 26 |
| 28 | 218.2 | 218.3 | 208 | 197 | 186.8 | 155.4 | 128.6 | 101.9 | | | | | | | | 28 |
| 30 | 202.9 | 205.1 | 198 | 188.3 | 182.4 | 154.4 | 128 | 101.6 | 82.1 | | | | | | | 30 |
| 32 | 189.4 | 191.5 | 188.9 | 180.4 | 174.6 | 153.2 | 127.4 | 101.2 | 82 | | | | | | | 32 |
| 34 | 177.5 | 179.5 | 179.5 | 172.7 | 167.5 | 151.9 | 126.8 | 100.9 | 81.8 | 66.1 | | | | | | 34 |
| 36 | 166.8 | 168.7 | 169.5 | 165.2 | 161.1 | 150.5 | 126.1 | 100.5 | 81.5 | 65.8 | | | | | | 36 |
| 38 | 156 | 159.1 | 159.8 | 158.1 | 155.1 | 147.1 | 125.1 | 99.1 | 81.1 | 65.6 | 54.1 | | | | | 38 |
| 40 | 130.5 | 150.5 | 151.1 | 150.6 | 149.2 | 142.2 | 123.9 | 97.6 | 80.6 | 65.4 | 53.9 | | | | | 40 |
| 45 | | 131.9 | 132.6 | 132.2 | 133.9 | 130.1 | 120.6 | 92.3 | 78.6 | 64.6 | 53.4 | 43.6 | | | | 45 |
| 50 | | 118.4 | 117.6 | 119.9 | 119 | 117.7 | 115.2 | 86.4 | 75.4 | 63.3 | 52.9 | 43.3 | 36.5 | 30.3 | | 50 |
| 55 | | 96.1 | 107.6 | 107.6 | 106.8 | 105.5 | 106.9 | 81.2 | 71.2 | 61.2 | 52.1 | 42.5 | 36.1 | 30.1 | 29.3 | 55 |
| 60 | | | 97.3 | 97.4 | 96.5 | 98 | 97.1 | 76.2 | 67.3 | 58.4 | 50.5 | 41.5 | 35.4 | 29.9 | 29.2 | 60 |
| 65 | | | 88.4 | 88.4 | 87.4 | 89.6 | 88.1 | 71.5 | 63.5 | 55.5 | 48.5 | 40.4 | 34.6 | 29.4 | 28.8 | 65 |
| 70 | | | 74.2 | 80.6 | 79.6 | 81.8 | 80.3 | 67.3 | 59.8 | 52.8 | 46.5 | 39.1 | 33.7 | 28.8 | 28.4 | 70 |
| 75 | | | | 73.8 | 74 | 74.9 | 73.5 | 63.3 | 56.2 | 50.1 | 44.5 | 37.8 | 32.7 | 28 | 27.7 | 75 |
| 80 | | | | 68 | 69.8 | 69 | 67.5 | 59.6 | 53.1 | 47.5 | 42.6 | 36.5 | 31.6 | 27.1 | 26.8 | 80 |
| 85 | | | | 60.7 | 64.8 | 63.8 | 62.2 | 56.2 | 50.1 | 45.1 | 40.6 | 35.3 | 30.5 | 26.3 | 26 | 85 |
| 90 | | | | | 60.2 | 59.1 | 57.6 | 52.8 | 47.3 | 42.9 | 38.7 | 34 | 29.5 | 25.4 | 25.2 | 90 |
| 95 | | | | | 56.1 | 55 | 53.4 | 49.5 | 44.9 | 40.7 | 36.9 | 32.8 | 28.6 | 24.6 | 24.4 | 95 |
| 100 | | | | | 49.3 | 51.3 | 49.7 | 46.9 | 42.5 | 38.6 | 35.2 | 31.6 | 27.6 | 23.8 | 23.6 | 100 |
| 105 | | | | | 25.6 | 47.9 | 46.3 | 44.3 | 40.1 | 36.8 | 33.6 | 30.5 | 26.7 | 23 | 22.9 | 105 |
| 110 | | | | | | 44.9 | 43.2 | 41.9 | 38.1 | 34.9 | 32.1 | 29.3 | 25.7 | 22.3 | 22.2 | 110 |
| 115 | | | | | | 39.6 | 40.4 | 40.6 | 36.2 | 33.1 | 30.6 | 28.2 | 25 | 21.5 | 21.5 | 115 |
| 120 | | | | | | 27.2 | 37.9 | 39.2 | 34.4 | 31.5 | 29.2 | 27.1 | 24.2 | 20.9 | 20.8 | 120 |
| 125 | | | | | | | 35.9 | 37 | 32.7 | 30.1 | 27.9 | 26 | 23.4 | 20.2 | 20.2 | 125 |
| 130 | | | | | | | 34.7 | 34.9 | 31.1 | 28.6 | 26.5 | 25 | 22.6 | 19.6 | 19.6 | 130 |
| 135 | | | | | | | 24.2 | 32.9 | 29.3 | 27.2 | 25.4 | 23.9 | 22 | 19 | 19 | 135 |
| 140 | | | | | | | | 31 | 27.9 | 26 | 24.2 | 22.9 | 21.3 | 18.4 | 18.4 | 140 |
| 145 | | | | | | | | 27.5 | 26.8 | 24.8 | 23.1 | 22 | 20.6 | 17.8 | 17.7 | 145 |
| 150 | | | | | | | | 21.8 | 25.6 | 23.6 | 22.1 | 21.1 | 20 | 17.3 | 17.1 | 150 |
| 155 | | | | | | | | | 24.7 | 22.6 | 21.1 | 20.2 | 19.3 | 16.7 | 16.5 | 155 |
| 160 | | | | | | | | | 24 | 21.6 | 20.2 | 19.3 | 18.6 | 16.2 | 15.8 | 160 |
| 165 | | | | | | | | | 18.6 | 20.8 | 19.3 | 18.5 | 17.9 | 15.6 | 15.2 | 165 |
| 170 | | | | | | | | | | 20 | 18.5 | 17.8 | 17.2 | 15.1 | 14.6 | 170 |
| 175 | | | | | | | | | | 18.7 | 17.8 | 17 | 16.5 | 14.6 | 14 | 175 |
| 180 | | | | | | | | | | 15.3 | 17.2 | 16.3 | 15.9 | 14.2 | 13.3 | 180 |
| 185 | | | | | | | | | | | 16.6 | 15.6 | 15.3 | 13.7 | 12.7 | 185 |
| 190 | | | | | | | | | | | 15.7 | 15 | 14.6 | 13.2 | 12.2 | 190 |
| 195 | | | | | | | | | | | 13.2 | 14.6 | 14 | 12.8 | 11.6 | 195 |
| 200 | | | | | | | | | | | 5.4 | 14.2 | 13.5 | 12.3 | 11.1 | 200 |
| 205 | | | | | | | | | | | | 13.7 | 13 | 11.9 | 10.6 | 205 |
| 210 | | | | | | | | | | | | 10.3 | 12.5 | 11.4 | 10.1 | 210 |
| 215 | | | | | | | | | | | | 4.7 | 11.8 | 11 | 9.6 | 215 |
| 220 | | | | | | | | | | | | | 10.3 | 10.6 | 9.2 | 220 |
| 225 | | | | | | | | | | | | | 7.2 | 10.2 | 8.7 | 225 |
| 230 | | | | | | | | | | | | | | 9.6 | 8.3 | 230 |
| 235 | | | | | | | | | | | | | | 7.6 | 7.9 | 235 |
| 240 | | | | | | | | | | | | | | 4.8 | 5.9 | 240 |

t_240_001_50201_00_000

Lifting capacities Forces de levage

T

48 - 256 ft
360°
123500 lbs
85%

| ft | 48 ft | 64 ft | 80 ft | 96 ft | 112 ft | 128 ft | 144 ft | 160 ft | 176 ft | 192 ft | 208 ft | 224 ft | 240 ft | 253 ft | 256 ft | ft |
|-----|-------|-------|-------|-------|--------|--------|--------|--------|--------|--------|--------|--------|--------|--------|--------|-----|
| 10 | 298.6 | | | | | | | | | | | | | | | 10 |
| 11 | 298.6 | 298.6 | | | | | | | | | | | | | | 11 |
| 12 | 298.6 | 298.6 | 298.6 | | | | | | | | | | | | | 12 |
| 13 | 298.6 | 298.6 | 298.6 | | | | | | | | | | | | | 13 |
| 14 | 298.6 | 298.6 | 298.6 | | | | | | | | | | | | | 14 |
| 15 | 298.6 | 298.6 | 298.6 | 248.3 | 191.2 | | | | | | | | | | | 15 |
| 16 | 298.6 | 298.6 | 290.6 | 247.8 | 198.4 | | | | | | | | | | | 16 |
| 17 | 294.7 | 296.2 | 279.6 | 246.7 | 198 | | | | | | | | | | | 17 |
| 18 | 283.8 | 284.5 | 272.7 | 245.5 | 197.6 | | | | | | | | | | | 18 |
| 19 | 272.1 | 272.9 | 264.2 | 244.2 | 197.1 | 159.8 | | | | | | | | | | 19 |
| 20 | 260.7 | 262.7 | 256.3 | 241.9 | 196.2 | 159.3 | | | | | | | | | | 20 |
| 22 | 239.6 | 241.8 | 241.8 | 230.3 | 194.3 | 158.3 | 130.2 | | | | | | | | | 22 |
| 24 | 220.5 | 222.6 | 223.1 | 217.7 | 192.3 | 157.4 | 129.7 | | | | | | | | | 24 |
| 26 | 202.5 | 204.9 | 205.8 | 204.4 | 190.4 | 156.4 | 129.2 | 102.1 | | | | | | | | 26 |
| 28 | 187 | 189.3 | 190.1 | 189.2 | 186 | 155.4 | 128.6 | 101.9 | | | | | | | | 28 |
| 30 | 173.4 | 176.4 | 176.2 | 178.5 | 173.9 | 154.4 | 128 | 101.6 | 82.1 | | | | | | | 30 |
| 32 | 160.9 | 164.8 | 166.5 | 166.7 | 162.4 | 152.7 | 127.4 | 101.2 | 82 | | | | | | | 32 |
| 34 | 149.3 | 153.3 | 155.1 | 155.4 | 152.1 | 145.3 | 126.8 | 100.9 | 81.8 | 66.1 | | | | | | 34 |
| 36 | 139.1 | 142.9 | 144.9 | 144.8 | 143 | 136.7 | 126.1 | 100.5 | 81.5 | 65.8 | | | | | | 36 |
| 38 | 130 | 133.8 | 135.7 | 135.9 | 134.6 | 131.9 | 124.2 | 99.1 | 81.1 | 65.6 | 54.1 | | | | | 38 |
| 40 | 121.9 | 125.7 | 127.4 | 127.6 | 126.6 | 126 | 120.3 | 97.6 | 80.6 | 65.4 | 53.9 | | | | | 40 |
| 45 | | 108.4 | 110.2 | 110.2 | 111.7 | 110.3 | 104.3 | 92.3 | 78.6 | 64.6 | 53.4 | 43.6 | | | | 45 |
| 50 | | 93.2 | 95.2 | 96.8 | 98.1 | 96.2 | 90.7 | 85.3 | 75.4 | 63.3 | 52.9 | 43.3 | 36.5 | 30.3 | | 50 |
| 55 | | 79.9 | 81.9 | 85.1 | 84.8 | 83.7 | 79.6 | 75.8 | 70.9 | 61.2 | 52.1 | 42.5 | 36.1 | 30.1 | 29.3 | 55 |
| 60 | | | 73 | 74.1 | 73.8 | 72.7 | 70.9 | 67.8 | 63.7 | 58.4 | 50.5 | 41.5 | 35.4 | 29.9 | 29.2 | 60 |
| 65 | | | 64.4 | 65.2 | 64.9 | 63.7 | 62.5 | 61.4 | 58 | 54.3 | 48.5 | 40.4 | 34.6 | 29.4 | 28.8 | 65 |
| 70 | | | 57.2 | 57.9 | 57.6 | 56.5 | 56.5 | 56.5 | 52.6 | 48.8 | 46 | 39.1 | 33.7 | 28.8 | 28.4 | 70 |
| 75 | | | | 51.8 | 51.5 | 50.3 | 52 | 50.6 | 47.3 | 45.9 | 42.7 | 37.8 | 32.7 | 28 | 27.7 | 75 |
| 80 | | | | 46.7 | 46.3 | 46.8 | 47.2 | 45.4 | 42.7 | 41.8 | 38.6 | 36.5 | 31.6 | 27.1 | 26.8 | 80 |
| 85 | | | | 42.4 | 41.9 | 43.9 | 42.7 | 40.9 | 39.9 | 37.9 | 36 | 34.3 | 30.5 | 26.3 | 26 | 85 |
| 90 | | | | | 38.6 | 40 | 38.8 | 37.5 | 37.7 | 34.5 | 34.1 | 31.7 | 29.5 | 25.4 | 25.2 | 90 |
| 95 | | | | | 36.9 | 36.6 | 35.4 | 34.3 | 34.7 | 32.7 | 31.6 | 29.1 | 28.5 | 24.6 | 24.4 | 95 |
| 100 | | | | | 34.2 | 33.7 | 32.4 | 32.8 | 31.7 | 30.9 | 28.9 | 28 | 27 | 23.8 | 23.6 | 100 |
| 105 | | | | | 25.6 | 31 | 30.1 | 30.7 | 29.1 | 29.4 | 27.1 | 26.5 | 25.1 | 23 | 22.9 | 105 |
| 110 | | | | | | 28.6 | 28.3 | 28.3 | 27.2 | 27 | 25.9 | 24.7 | 23 | 22 | 22 | 110 |
| 115 | | | | | | 26.5 | 27.2 | 26.2 | 26 | 24.8 | 24.4 | 22.8 | 21.1 | 20.6 | 20.3 | 115 |
| 120 | | | | | | 24.7 | 25.4 | 24.2 | 24.4 | 22.9 | 22.9 | 21.1 | 19.4 | 19 | 18.7 | 120 |
| 125 | | | | | | | 23.6 | 22.3 | 22.6 | 22 | 21.2 | 19.5 | 17.8 | 17.4 | 17.1 | 125 |
| 130 | | | | | | | 22 | 21.5 | 20.8 | 20.6 | 19.4 | 18 | 16.3 | 16 | 15.7 | 130 |
| 135 | | | | | | | 20.5 | 20.5 | 19.2 | 19.1 | 17.8 | 16.6 | 14.9 | 14.7 | 14.4 | 135 |
| 140 | | | | | | | | 19 | 18 | 17.6 | 16.4 | 15.3 | 13.6 | 13.4 | 13.1 | 140 |
| 145 | | | | | | | | 17.7 | 16.7 | 16.2 | 15 | 14 | 12.4 | 12.3 | 12 | 145 |
| 150 | | | | | | | | 16.6 | 15.5 | 15 | 13.8 | 12.8 | 11.3 | 11.2 | 10.9 | 150 |
| 155 | | | | | | | | | 14.4 | 13.9 | 12.6 | 11.6 | 10.1 | 10.2 | 9.9 | 155 |
| 160 | | | | | | | | | 13.4 | 12.8 | 11.5 | 10.5 | 9.1 | 9.2 | 8.9 | 160 |
| 165 | | | | | | | | | 12.4 | 11.8 | 10.6 | 9.5 | 8.1 | 8.3 | 8 | 165 |
| 170 | | | | | | | | | | 10.9 | 9.6 | 8.6 | 7.1 | 7.4 | 7.2 | 170 |
| 175 | | | | | | | | | | 10 | 8.8 | 7.7 | 6.2 | 6.5 | 6.3 | 175 |
| 180 | | | | | | | | | | 9.2 | 7.9 | 6.9 | 5.4 | 5.7 | 5.4 | 180 |
| 185 | | | | | | | | | | | 7.2 | 6.1 | 4.7 | 4.9 | 4.7 | 185 |
| 190 | | | | | | | | | | | 6.5 | 5.4 | 3.9 | 4.2 | 4 | 190 |
| 195 | | | | | | | | | | | 5.8 | 4.7 | | 3.5 | | 195 |
| 200 | | | | | | | | | | | 5.2 | 4.1 | | | | 200 |
| 205 | | | | | | | | | | | | 3.5 | | | | 205 |
| 210 | | | | | | | | | | | | | | | | 210 |

t_240_001_00303_00_000

Lifting capacities Forces de levage

T

48 - 256 ft
T
±10°
123500 lbs
85%

| ft | 48 ft | 64 ft | 80 ft | 96 ft | 112 ft | 128 ft | 144 ft | 160 ft | 176 ft | 192 ft | 208 ft | 224 ft | 240 ft | 253 ft | 256 ft | ft |
|-----|-------|-------|-------|-------|--------|--------|--------|--------|--------|--------|--------|--------|--------|--------|--------|-----|
| 10 | 298.6 | | | | | | | | | | | | | | | 10 |
| 11 | 298.6 | 298.6 | | | | | | | | | | | | | | 11 |
| 12 | 298.6 | 298.6 | 298.6 | | | | | | | | | | | | | 12 |
| 13 | 298.6 | 298.6 | 298.6 | | | | | | | | | | | | | 13 |
| 14 | 298.6 | 298.6 | 298.6 | | | | | | | | | | | | | 14 |
| 15 | 298.6 | 298.6 | 298.6 | 248.3 | 191.2 | | | | | | | | | | | 15 |
| 16 | 298.6 | 298.6 | 290.6 | 247.8 | 198.4 | | | | | | | | | | | 16 |
| 17 | 298.6 | 296.2 | 279.6 | 246.7 | 198 | | | | | | | | | | | 17 |
| 18 | 298.6 | 287.2 | 272.7 | 245.5 | 197.6 | | | | | | | | | | | 18 |
| 19 | 285.3 | 278.8 | 264.2 | 244.2 | 197.1 | 159.8 | | | | | | | | | | 19 |
| 20 | 271.2 | 268.7 | 256.3 | 241.9 | 196.2 | 159.3 | | | | | | | | | | 20 |
| 22 | 246.1 | 248.5 | 241.9 | 230.3 | 194.3 | 158.3 | 130.2 | | | | | | | | | 22 |
| 24 | 225.1 | 227.3 | 227.2 | 217.8 | 192.3 | 157.4 | 129.7 | | | | | | | | | 24 |
| 26 | 206.9 | 209.2 | 210 | 206.6 | 190.4 | 156.4 | 129.2 | 102.1 | | | | | | | | 26 |
| 28 | 191.4 | 193.6 | 194.3 | 193.5 | 186.8 | 155.4 | 128.6 | 101.9 | | | | | | | | 28 |
| 30 | 177.8 | 179.9 | 180.5 | 180.7 | 179.5 | 154.4 | 128 | 101.6 | 82.1 | | | | | | | 30 |
| 32 | 165.8 | 168.6 | 168.4 | 170.3 | 168.3 | 153.2 | 127.4 | 101.2 | 82 | | | | | | | 32 |
| 34 | 154.9 | 158.5 | 159.6 | 160.2 | 158.2 | 148.7 | 126.8 | 100.9 | 81.8 | 66.1 | | | | | | 34 |
| 36 | 144.9 | 148.6 | 150.3 | 150.3 | 148.8 | 140 | 126.1 | 100.5 | 81.5 | 65.8 | | | | | | 36 |
| 38 | 136 | 139.6 | 141.4 | 141.5 | 138.9 | 132.1 | 124.8 | 99.1 | 81.1 | 65.6 | 54.1 | | | | | 38 |
| 40 | 127.8 | 131.5 | 133.2 | 133.3 | 129.9 | 127.1 | 121.1 | 97.6 | 80.6 | 65.4 | 53.9 | | | | | 40 |
| 45 | | 110.4 | 112.8 | 112.8 | 113.1 | 110.5 | 104.5 | 92.3 | 78.6 | 64.6 | 53.4 | 43.6 | | | | 45 |
| 50 | | 93.2 | 95.2 | 96.8 | 98.2 | 96.4 | 91.4 | 85.8 | 75.4 | 63.3 | 52.9 | 43.3 | 36.5 | 30.3 | | 50 |
| 55 | | 79.9 | 81.9 | 85.1 | 84.8 | 83.8 | 80.5 | 76.5 | 71.2 | 61.2 | 52.1 | 42.5 | 36.1 | 30.1 | 29.3 | 55 |
| 60 | | | 73.2 | 74.4 | 74.1 | 73 | 71.1 | 69 | 64.9 | 58.4 | 50.5 | 41.5 | 35.4 | 29.9 | 29.2 | 60 |
| 65 | | | 65 | 65.8 | 65.4 | 64.3 | 63.1 | 61.8 | 58.5 | 54.7 | 48.5 | 40.4 | 34.6 | 29.4 | 28.8 | 65 |
| 70 | | | 57.9 | 58.7 | 58.3 | 57.3 | 56.7 | 57 | 53.8 | 50.1 | 46.4 | 39.1 | 33.7 | 28.8 | 28.4 | 70 |
| 75 | | | | 52.7 | 52.3 | 51.2 | 52.5 | 51.5 | 48.6 | 45.9 | 44 | 37.8 | 32.7 | 28 | 27.7 | 75 |
| 80 | | | | 47.7 | 47.2 | 46.8 | 48.1 | 46.4 | 44 | 42.8 | 39.9 | 36.5 | 31.6 | 27.1 | 26.8 | 80 |
| 85 | | | | 43.4 | 42.9 | 44.5 | 43.6 | 41.9 | 40 | 39.2 | 36.3 | 35.1 | 30.5 | 26.3 | 26 | 85 |
| 90 | | | | | 39.1 | 41 | 39.8 | 38.4 | 37.7 | 35.8 | 34.5 | 33 | 29.5 | 25.4 | 25.2 | 90 |
| 95 | | | | | 37 | 37.6 | 36.4 | 35.2 | 35.8 | 32.7 | 32.9 | 30.2 | 28.6 | 24.6 | 24.4 | 95 |
| 100 | | | | | 35.2 | 34.6 | 33.4 | 32.9 | 32.7 | 31.1 | 30.2 | 28 | 27.6 | 23.8 | 23.6 | 100 |
| 105 | | | | | 25.6 | 32 | 30.8 | 31.4 | 30.1 | 29.6 | 27.8 | 26.9 | 26.1 | 23 | 22.9 | 105 |
| 110 | | | | | | 29.6 | 28.7 | 29.3 | 27.8 | 28 | 26.1 | 25.8 | 24.2 | 22.3 | 22.1 | 110 |
| 115 | | | | | | 27.5 | 27.2 | 27.2 | 26.1 | 25.8 | 25 | 24 | 22.3 | 21.5 | 21.2 | 115 |
| 120 | | | | | | 25.7 | 26.2 | 25.2 | 25 | 23.8 | 23.7 | 22.2 | 20.5 | 20.1 | 19.8 | 120 |
| 125 | | | | | | | 24.6 | 23.4 | 23.6 | 22 | 22.2 | 20.6 | 18.9 | 18.6 | 18.2 | 125 |
| 130 | | | | | | | 23 | 21.7 | 21.8 | 21.1 | 20.4 | 19.1 | 17.4 | 17.1 | 16.8 | 130 |
| 135 | | | | | | | 21.5 | 20.7 | 20.2 | 20 | 18.8 | 17.7 | 16 | 15.8 | 15.4 | 135 |
| 140 | | | | | | | | 19.9 | 18.8 | 18.6 | 17.4 | 16.3 | 14.7 | 14.5 | 14.2 | 140 |
| 145 | | | | | | | | 18.7 | 17.4 | 17.2 | 16 | 15 | 13.5 | 13.3 | 13 | 145 |
| 150 | | | | | | | | 17.5 | 16.4 | 15.9 | 14.7 | 13.7 | 12.2 | 12.2 | 11.9 | 150 |
| 155 | | | | | | | | | 15.3 | 14.8 | 13.6 | 12.5 | 11.1 | 11.2 | 10.9 | 155 |
| 160 | | | | | | | | | 14.2 | 13.7 | 12.5 | 11.5 | 10 | 10.2 | 9.9 | 160 |
| 165 | | | | | | | | | 13.3 | 12.7 | 11.5 | 10.4 | 9 | 9.2 | 9 | 165 |
| 170 | | | | | | | | | | 11.7 | 10.5 | 9.5 | 8 | 8.3 | 8.1 | 170 |
| 175 | | | | | | | | | | 10.9 | 9.6 | 8.6 | 7.1 | 7.4 | 7.2 | 175 |
| 180 | | | | | | | | | | | 10.1 | 8.8 | 7.8 | 6.3 | 6.3 | 180 |
| 185 | | | | | | | | | | | | 8 | 7 | 5.5 | 5.5 | 185 |
| 190 | | | | | | | | | | | | | 7.3 | 6.2 | 4.8 | 190 |
| 195 | | | | | | | | | | | | | | 6.6 | 4.3 | 195 |
| 200 | | | | | | | | | | | | | | | 4.3 | 200 |
| 205 | | | | | | | | | | | | | | | | 205 |
| 210 | | | | | | | | | | | | | | | | 210 |

t_240_001_00203_00_000

Lifting capacities Forces de levage

T







| ft | 48 ft | 64 ft | 80 ft | 96 ft | 112 ft | 128 ft | 144 ft | 160 ft | 176 ft | 192 ft | 208 ft | 224 ft | 240 ft | 253 ft | 256 ft | ft |
|-----|-------|-------|-------|-------|--------|--------|--------|--------|--------|--------|--------|--------|--------|--------|--------|-----|
| 10 | 298.6 | | | | | | | | | | | | | | | 10 |
| 11 | 298.6 | 298.6 | | | | | | | | | | | | | | 11 |
| 12 | 298.6 | 298.6 | 298.6 | | | | | | | | | | | | | 12 |
| 13 | 298.6 | 298.6 | 298.6 | | | | | | | | | | | | | 13 |
| 14 | 298.6 | 298.6 | 298.6 | | | | | | | | | | | | | 14 |
| 15 | 298.6 | 298.6 | 298.6 | 248.3 | 191.2 | | | | | | | | | | | 15 |
| 16 | 297.4 | 298.5 | 290.6 | 247.8 | 198.4 | | | | | | | | | | | 16 |
| 17 | 291.7 | 291.9 | 279.6 | 246.7 | 198 | | | | | | | | | | | 17 |
| 18 | 278.6 | 279.1 | 272.7 | 245.5 | 197.6 | | | | | | | | | | | 18 |
| 19 | 266.3 | 267.7 | 264.2 | 244.2 | 197.1 | 159.8 | | | | | | | | | | 19 |
| 20 | 254.5 | 256.7 | 255.4 | 241.9 | 196.2 | 159.3 | | | | | | | | | | 20 |
| 22 | 232 | 234.6 | 234.7 | 229.8 | 194.3 | 158.3 | 130.2 | | | | | | | | | 22 |
| 24 | 211.7 | 214.2 | 214.6 | 212.1 | 192.3 | 157.4 | 129.7 | | | | | | | | | 24 |
| 26 | 194.3 | 196.7 | 197.6 | 196 | 189.4 | 156.4 | 129.2 | 102.1 | | | | | | | | 26 |
| 28 | 178.8 | 182.7 | 182 | 184.5 | 176.8 | 155.4 | 128.6 | 101.9 | | | | | | | | 28 |
| 30 | 164.3 | 168.5 | 170.2 | 170.1 | 164.3 | 153.3 | 128 | 101.6 | 82.1 | | | | | | | 30 |
| 32 | 151.7 | 155.8 | 157.4 | 157.9 | 152.9 | 144.8 | 127.4 | 101.2 | 82 | | | | | | | 32 |
| 34 | 140.6 | 144.6 | 146.5 | 146.7 | 141.3 | 137.9 | 126.8 | 100.9 | 81.8 | 66.1 | | | | | | 34 |
| 36 | 130.9 | 134.8 | 136.7 | 136.6 | 131.1 | 129 | 120.6 | 100.5 | 81.5 | 65.8 | | | | | | 36 |
| 38 | 122.1 | 126 | 128 | 128.1 | 125.3 | 120.1 | 112.7 | 99.1 | 81.1 | 65.6 | 54.1 | | | | | 38 |
| 40 | 113.4 | 117.7 | 119.7 | 119.7 | 118.7 | 112.1 | 105.2 | 96.5 | 80.6 | 65.4 | 53.9 | | | | | 40 |
| 45 | | 97.1 | 99.5 | 102.8 | 101.1 | 95.5 | 89.7 | 85.8 | 78.6 | 64.6 | 53.4 | 43.6 | | | | 45 |
| 50 | | 82.2 | 85.2 | 86.5 | 86.1 | 82.8 | 78.3 | 74.2 | 70 | 63.3 | 52.9 | 43.3 | 36.5 | 30.3 | | 50 |
| 55 | | 69.8 | 72.9 | 73.9 | 73.6 | 72.1 | 69.7 | 67.1 | 63.2 | 58.9 | 52.1 | 42.5 | 36.1 | 30.1 | 29.3 | 55 |
| 60 | | | 63.1 | 64 | 63.7 | 62.6 | 62 | 60.4 | 55.9 | 53.4 | 49.4 | 41.5 | 35.4 | 29.9 | 29.2 | 60 |
| 65 | | | 55.2 | 56.1 | 55.7 | 55.5 | 56.7 | 53.8 | 50.3 | 48.2 | 44.2 | 40.4 | 34.6 | 29.4 | 28.8 | 65 |
| 70 | | | 48.8 | 49.6 | 49.2 | 51.2 | 50.2 | 48.1 | 45.9 | 42.9 | 40.7 | 38.9 | 33.7 | 28.8 | 28.4 | 70 |
| 75 | | | | 44.2 | 44.9 | 45.9 | 44.8 | 43.5 | 42.5 | 39.7 | 38.1 | 35 | 32.7 | 28 | 27.7 | 75 |
| 80 | | | | 39.6 | 41.8 | 41.3 | 40.1 | 39.2 | 39 | 36.6 | 34.5 | 32.7 | 31.4 | 27.1 | 26.8 | 80 |
| 85 | | | | 35.8 | 37.8 | 37.3 | 36.8 | 36.9 | 35.3 | 34.2 | 32.3 | 30.7 | 29 | 26.2 | 26 | 85 |
| 90 | | | | | 34.4 | 33.9 | 33.6 | 33.7 | 32.4 | 31.4 | 30.3 | 28.4 | 26.5 | 25.2 | 24.7 | 90 |
| 95 | | | | | 31.4 | 30.9 | 31.7 | 30.6 | 30.8 | 28.7 | 28 | 25.8 | 24 | 23.5 | 23.1 | 95 |
| 100 | | | | | 28.8 | 28.2 | 29.1 | 28 | 28.1 | 27.2 | 25.6 | 23.6 | 21.8 | 21.3 | 20.9 | 100 |
| 105 | | | | | 25.6 | 26.9 | 26.7 | 26.5 | 25.8 | 25.6 | 23.5 | 21.5 | 19.8 | 19.4 | 19 | 105 |
| 110 | | | | | | 25.2 | 24.6 | 24.7 | 23.6 | 23.5 | 21.6 | 19.7 | 18 | 17.6 | 17.2 | 110 |
| 115 | | | | | | 23.3 | 22.7 | 22.8 | 21.9 | 21.4 | 19.8 | 17.9 | 16.3 | 16 | 15.6 | 115 |
| 120 | | | | | | 21.6 | 21 | 21 | 20 | 19.6 | 18.2 | 16.4 | 14.8 | 14.5 | 14.2 | 120 |
| 125 | | | | | | | 19.4 | 19.3 | 18.4 | 17.9 | 16.6 | 15 | 13.3 | 13.1 | 12.7 | 125 |
| 130 | | | | | | | 17.9 | 17.8 | 16.8 | 16.3 | 15.1 | 13.6 | 12 | 11.8 | 11.5 | 130 |
| 135 | | | | | | | 16.6 | 16.4 | 15.4 | 14.9 | 13.7 | 12.4 | 10.8 | 10.6 | 10.3 | 135 |
| 140 | | | | | | | | 15.1 | 14.1 | 13.7 | 12.4 | 11.3 | 9.7 | 9.5 | 9.2 | 140 |
| 145 | | | | | | | | 13.9 | 12.9 | 12.5 | 11.2 | 10.2 | 8.6 | 8.5 | 8.2 | 145 |
| 150 | | | | | | | | 12.9 | 11.9 | 11.3 | 10.1 | 9.1 | 7.6 | 7.5 | 7.2 | 150 |
| 155 | | | | | | | | | 10.9 | 10.3 | 9.1 | 8.1 | 6.6 | 6.6 | 6.3 | 155 |
| 160 | | | | | | | | | 10 | 9.4 | 8.1 | 7.1 | 5.7 | 5.8 | 5.5 | 160 |
| 165 | | | | | | | | | | 9.1 | 8.5 | 7.3 | 6.2 | 5 | 4.7 | 165 |
| 170 | | | | | | | | | | | 7.7 | 6.4 | 5.4 | 4.2 | 3.8 | 170 |
| 175 | | | | | | | | | | | 6.9 | 5.7 | 4.6 | | | 175 |
| 180 | | | | | | | | | | | 6.2 | 5 | 3.9 | | | 180 |
| 185 | | | | | | | | | | | | 4.3 | | | | 185 |
| 190 | | | | | | | | | | | | 3.7 | | | | 190 |

t_240_001_00304_00_000

Lifting capacities Forces de levage

T

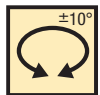
48 - 256 ft

85%

| ft | 48 ft | 64 ft | 80 ft | 96 ft | 112 ft | 128 ft | 144 ft | 160 ft | 176 ft | 192 ft | 208 ft | 224 ft | 240 ft | 253 ft | 256 ft | ft |
|-----|-------|-------|-------|-------|--------|--------|--------|--------|--------|--------|--------|--------|--------|--------|--------|-----|
| 10 | 298.6 | | | | | | | | | | | | | | | 10 |
| 11 | 298.6 | 298.6 | | | | | | | | | | | | | | 11 |
| 12 | 298.6 | 298.6 | 298.6 | | | | | | | | | | | | | 12 |
| 13 | 298.6 | 298.6 | 298.6 | | | | | | | | | | | | | 13 |
| 14 | 298.6 | 298.6 | 298.6 | | | | | | | | | | | | | 14 |
| 15 | 298.6 | 298.6 | 298.6 | 248.3 | 191.2 | | | | | | | | | | | 15 |
| 16 | 298.6 | 298.6 | 290.6 | 247.8 | 198.4 | | | | | | | | | | | 16 |
| 17 | 296.2 | 296.2 | 279.6 | 246.7 | 198 | | | | | | | | | | | 17 |
| 18 | 289.5 | 287.2 | 272.7 | 245.5 | 197.6 | | | | | | | | | | | 18 |
| 19 | 275.5 | 275.8 | 264.2 | 244.2 | 197.1 | 159.8 | | | | | | | | | | 19 |
| 20 | 261.6 | 263.9 | 256.3 | 241.9 | 196.2 | 159.3 | | | | | | | | | | 20 |
| 22 | 237.3 | 239.7 | 239.8 | 230.3 | 194.3 | 158.3 | 130.2 | | | | | | | | | 22 |
| 24 | 216.9 | 219.2 | 219.6 | 217.2 | 192.3 | 157.4 | 129.7 | | | | | | | | | 24 |
| 26 | 199.4 | 201.7 | 202.5 | 201.6 | 190.4 | 156.4 | 129.2 | 102.1 | | | | | | | | 26 |
| 28 | 184.4 | 186.6 | 187.3 | 187.9 | 181.4 | 155.4 | 128.6 | 101.9 | | | | | | | | 28 |
| 30 | 170.8 | 174.6 | 175.7 | 176 | 166.3 | 153.3 | 128 | 101.6 | 82.1 | | | | | | | 30 |
| 32 | 158.5 | 162.4 | 163.9 | 162.6 | 152.9 | 144.8 | 127.4 | 101.2 | 82 | | | | | | | 32 |
| 34 | 147.7 | 151.5 | 153.2 | 150.2 | 141.3 | 137.9 | 126.8 | 100.9 | 81.8 | 66.1 | | | | | | 34 |
| 36 | 136.5 | 141.7 | 142.9 | 138.8 | 131.2 | 129.1 | 121 | 100.5 | 81.5 | 65.8 | | | | | | 36 |
| 38 | 124 | 129.2 | 131.8 | 129.4 | 125.6 | 120.6 | 113.5 | 99.1 | 81.1 | 65.6 | 54.1 | | | | | 38 |
| 40 | 113.4 | 118.5 | 120.9 | 120.3 | 119.3 | 113 | 106.4 | 97.3 | 80.6 | 65.4 | 53.9 | | | | | 40 |
| 45 | | 97.2 | 99.5 | 102.8 | 102 | 97 | 91.4 | 87.1 | 78.6 | 64.6 | 53.4 | 43.6 | | | | 45 |
| 50 | | 82.9 | 85.2 | 87 | 86.7 | 84.6 | 80 | 76.3 | 71.7 | 63.3 | 52.9 | 43.3 | 36.5 | 30.3 | | 50 |
| 55 | | 71 | 74 | 74.9 | 74.6 | 73.6 | 70.5 | 68.4 | 65.4 | 60.2 | 52.1 | 42.5 | 36.1 | 30.1 | 29.3 | 55 |
| 60 | | | 64.4 | 65.3 | 64.9 | 63.9 | 63.8 | 62.5 | 58 | 53.7 | 50.5 | 41.5 | 35.4 | 29.9 | 29.2 | 60 |
| 65 | | | 56.7 | 57.5 | 57.2 | 56.7 | 58.1 | 56 | 51.6 | 49.8 | 46.3 | 40.4 | 34.6 | 29.4 | 28.8 | 65 |
| 70 | | | 50.4 | 51.1 | 50.8 | 52 | 51.7 | 49.9 | 47.4 | 44.9 | 41.5 | 39.1 | 33.7 | 28.8 | 28.4 | 70 |
| 75 | | | | 45.8 | 45.4 | 47.5 | 46.3 | 44.7 | 43.1 | 40.3 | 39.1 | 36.9 | 32.7 | 28 | 27.7 | 75 |
| 80 | | | | 41.2 | 42.6 | 42.9 | 41.7 | 40.4 | 40.8 | 37.7 | 36.2 | 33.4 | 31.6 | 27.1 | 26.8 | 80 |
| 85 | | | | 37.4 | 39.3 | 38.9 | 37.6 | 37.5 | 37 | 35.1 | 33.1 | 31.5 | 30.4 | 26.3 | 26 | 85 |
| 90 | | | | | 35.9 | 35.4 | 34.8 | 35.1 | 33.6 | 33 | 30.8 | 29.8 | 28.3 | 25.4 | 25.2 | 90 |
| 95 | | | | | 32.9 | 32.4 | 32.1 | 32.1 | 30.9 | 30.4 | 29.4 | 27.5 | 25.8 | 24.2 | 24.1 | 95 |
| 100 | | | | | 30.2 | 29.7 | 30.6 | 29.4 | 29.6 | 27.9 | 27.2 | 25.3 | 23.5 | 23 | 22.5 | 100 |
| 105 | | | | | 25.6 | 27.3 | 28.2 | 27 | 27.2 | 26.2 | 25.1 | 23.2 | 21.5 | 21 | 20.6 | 105 |
| 110 | | | | | | 25.9 | 26 | 25.4 | 25.1 | 24.9 | 23.2 | 21.3 | 19.6 | 19.2 | 18.8 | 110 |
| 115 | | | | | | 24.7 | 24 | 24.1 | 23.1 | 22.9 | 21.3 | 19.5 | 17.9 | 17.5 | 17.2 | 115 |
| 120 | | | | | | 23 | 22.3 | 22.3 | 21.3 | 21 | 19.6 | 17.9 | 16.3 | 16 | 15.6 | 120 |
| 125 | | | | | | | 20.6 | 20.6 | 19.7 | 19.3 | 18.1 | 16.5 | 14.8 | 14.6 | 14.2 | 125 |
| 130 | | | | | | | 19.1 | 19.1 | 18.2 | 17.7 | 16.5 | 15.1 | 13.5 | 13.2 | 12.9 | 130 |
| 135 | | | | | | | 17.9 | 17.7 | 16.7 | 16.3 | 15 | 13.8 | 12.2 | 12 | 11.7 | 135 |
| 140 | | | | | | | | 16.4 | 15.4 | 14.9 | 13.7 | 12.6 | 11.1 | 10.9 | 10.6 | 140 |
| 145 | | | | | | | | 15.2 | 14.2 | 13.7 | 12.5 | 11.5 | 10 | 9.8 | 9.5 | 145 |
| 150 | | | | | | | | 14.1 | 13.1 | 12.6 | 11.4 | 10.3 | 8.9 | 8.8 | 8.6 | 150 |
| 155 | | | | | | | | | 12 | 11.5 | 10.3 | 9.3 | 7.8 | 7.9 | 7.6 | 155 |
| 160 | | | | | | | | | 11.1 | 10.5 | 9.3 | 8.3 | 6.9 | 7 | 6.8 | 160 |
| 165 | | | | | | | | | 10.2 | 9.6 | 8.4 | 7.4 | 6 | 6.2 | 5.9 | 165 |
| 170 | | | | | | | | | | 8.8 | 7.6 | 6.5 | 5.1 | 5.3 | 5.1 | 170 |
| 175 | | | | | | | | | | 8 | 6.8 | 5.7 | 4.3 | 4.5 | 4.3 | 175 |
| 180 | | | | | | | | | | 7.3 | 6 | 5 | 3.5 | 3.7 | 3.5 | 180 |
| 185 | | | | | | | | | | | 5.3 | 4.3 | | | | 185 |
| 190 | | | | | | | | | | | 4.7 | 3.6 | | | | 190 |
| 195 | | | | | | | | | | | 4.1 | | | | | 195 |
| 200 | | | | | | | | | | | 3.6 | | | | | 200 |

t_240_001_00204_00_000

Lifting heights Hauteurs de levage

T

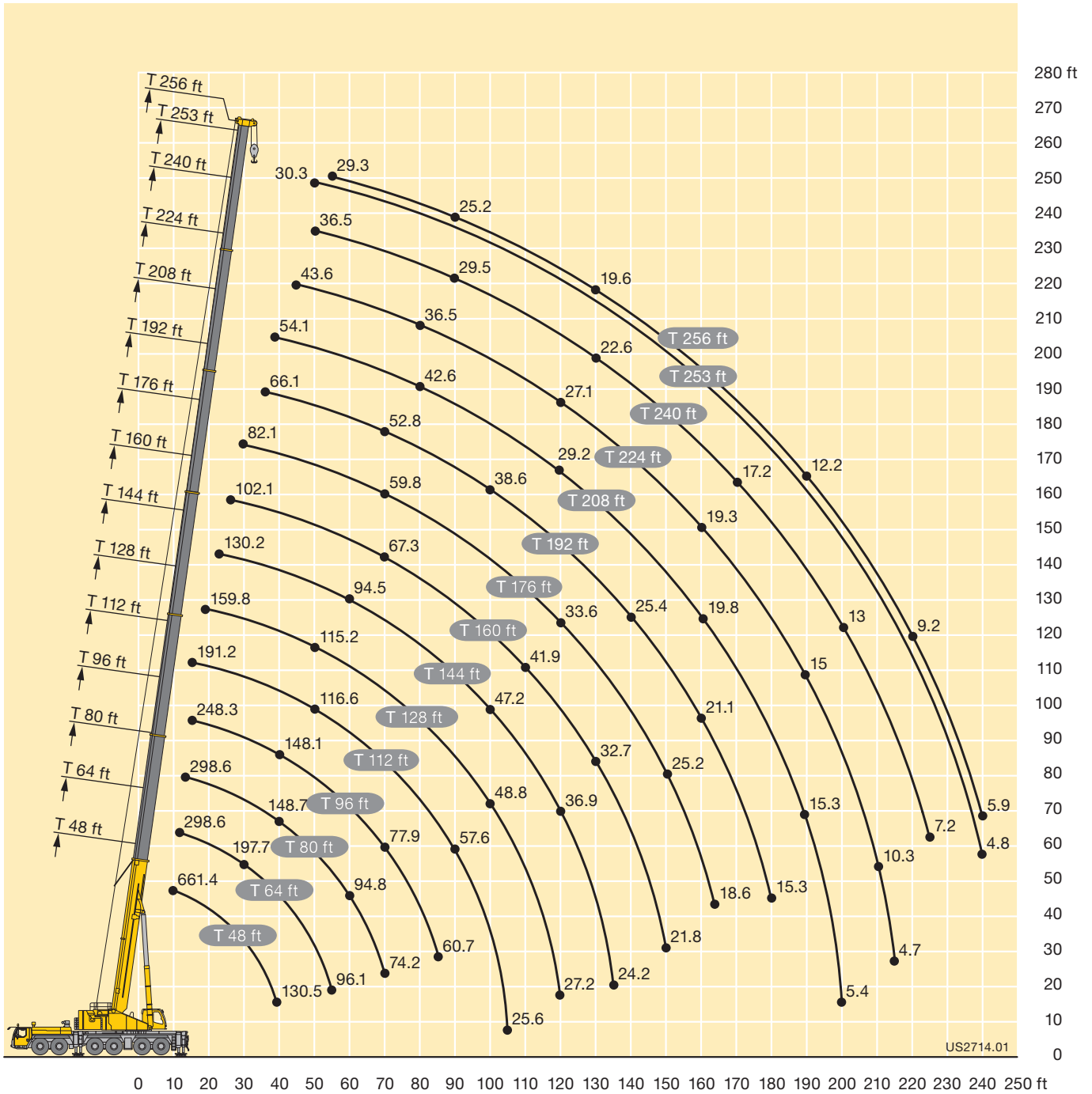

Lifting capacities Forces de levage

TK



| ft | 48 ft | | | 64 ft | | | 80 ft | | | 96 ft | | | 112 ft | | | 128 ft | | | 144 ft | | | 160 ft | | | ft |
|-----|-------|-------|------|-------|-------|-------|-------|-------|-------|-------|------|------|--------|-------|-------|--------|------|------|--------|------|------|--------|------|------|-----|
| | 18 ft | | | 18 ft | | | 18 ft | | | 18 ft | | | 18 ft | | | 18 ft | | | 18 ft | | | 18 ft | | | |
| | 0° | 20° | 40° | 0° | 20° | 40° | 0° | 20° | 40° | 0° | 20° | 40° | 0° | 20° | 40° | 0° | 20° | 40° | 0° | 20° | 40° | 0° | 20° | 40° | |
| 12 | 128.3 | 101.2 | | | | | | | | | | | | | | | | | | | | | | 12 | |
| 13 | 125.9 | 99.2 | 84.3 | 130.9 | 103 | | | | | | | | | | | | | | | | | | | 13 | |
| 14 | 122.7 | 97.2 | 82.9 | 130.3 | 101.1 | 130.4 | | | | | | | | | | | | | | | | | | 14 | |
| 15 | 119.5 | 95.3 | 81.7 | 127.6 | 99.4 | 83.9 | 129.2 | 100.7 | | | | | | | | | | | | | | | | 15 | |
| 16 | 116.3 | 93.5 | 80.5 | 124.9 | 97.8 | 82.8 | 127.4 | 99.6 | 126.8 | | | | | | | | | | | | | | | 16 | |
| 17 | 113.7 | 91.8 | 79.3 | 122.4 | 96.2 | 81.8 | 125.2 | 98.2 | 125.1 | | | | | | | | | | | | | | | 17 | |
| 18 | 111.2 | 90.1 | 78.2 | 120 | 94.7 | 80.8 | 123.1 | 96.8 | 81.8 | 123.4 | 97.5 | | | 121.2 | | | | | | | | | | 18 | |
| 19 | 108.6 | 88.4 | 77.1 | 117.6 | 93.3 | 79.9 | 121 | 95.5 | 81 | 121.7 | 96.4 | | | 119.9 | | | | | | | | | | 19 | |
| 20 | 106 | 86.9 | 76.1 | 115.2 | 91.9 | 78.9 | 119 | 94.2 | 80.2 | 120 | 95.3 | | | 118.6 | | | | | | | | | | 20 | |
| 22 | 101.2 | 84 | 74 | 110.7 | 89.2 | 77.1 | 115.1 | 91.7 | 78.5 | 116.6 | 93 | 79.4 | 115.9 | 93.5 | 105.6 | | | | | | | | | 22 | |
| 24 | 96.9 | 81.1 | 72.2 | 106.7 | 86.4 | 75.3 | 111.2 | 89.2 | 77 | 113.1 | 90.8 | 77.9 | 113.1 | 91.5 | 78.3 | 105.6 | 91.1 | | | | | | | 24 | |
| 26 | 92.9 | 78.6 | 70.4 | 102.6 | 84.1 | 73.6 | 107.5 | 87 | 75.4 | 109.9 | 88.7 | 76.5 | 110.2 | 89.5 | 77 | 105.3 | 89.6 | 95.2 | | | | | | 26 | |
| 28 | 89.1 | 76.1 | 68.8 | 98.8 | 81.8 | 72.2 | 104.2 | 84.8 | 74.1 | 106.9 | 86.7 | 75.2 | 107.5 | 87.6 | 75.8 | 104.7 | 88.2 | 76.8 | 94.7 | 83.6 | | | | 28 | |
| 30 | 86 | 73.8 | 67.3 | 95.4 | 79.5 | 70.8 | 101.1 | 82.8 | 72.7 | 103.9 | 84.8 | 73.9 | 104.8 | 85.8 | 74.6 | 103.9 | 86.9 | 75.8 | 94.2 | 82.7 | 79.4 | | | 30 | |
| 32 | 82.8 | 71.9 | 65.9 | 92.3 | 77.5 | 69.4 | 98 | 81 | 71.4 | 100.9 | 83 | 72.8 | 102.4 | 84.2 | 73.5 | 102.4 | 85.6 | 74.8 | 93.4 | 81.7 | 73 | 79.4 | | 32 | |
| 34 | 79.9 | 70.1 | 64.7 | 89.2 | 75.6 | 68.2 | 95.1 | 79.2 | 70.2 | 98.5 | 81.2 | 71.6 | 100.1 | 82.6 | 72.4 | 100.8 | 84.3 | 73.9 | 92.4 | 80.7 | 72.2 | 79.3 | 73.9 | 34 | |
| 36 | 77.4 | 68.3 | 63.6 | 86.5 | 73.8 | 67 | 92.4 | 77.5 | 69.1 | 96.1 | 79.6 | 70.5 | 97.8 | 81.1 | 71.4 | 99.1 | 83.1 | 73 | 91.5 | 79.8 | 71.4 | 79 | 73.3 | 67.7 | 36 |
| 38 | 74.9 | 66.7 | 62.6 | 84.1 | 72.1 | 65.9 | 89.9 | 75.9 | 68 | 93.7 | 78.2 | 69.5 | 95.6 | 79.7 | 70.5 | 97.4 | 81.8 | 72.2 | 90.4 | 78.8 | 70.7 | 78.6 | 72.7 | 67.2 | 38 |
| 40 | 72.6 | 65.2 | 61.7 | 81.7 | 70.7 | 64.9 | 87.6 | 74.3 | 67 | 91.4 | 76.8 | 68.5 | 93.6 | 78.2 | 69.5 | 95.7 | 80.6 | 71.3 | 89.3 | 77.9 | 69.9 | 78.2 | 72 | 66.6 | 40 |
| 45 | 67.9 | 62.2 | 60.1 | 76.3 | 67.2 | 62.7 | 82.3 | 70.8 | 64.8 | 86.3 | 73.3 | 66.3 | 88.9 | 75.2 | 67.4 | 91.6 | 77.6 | 69.4 | 86.3 | 75.4 | 68.2 | 76.5 | 70.2 | 65.2 | 45 |
| 50 | 64.1 | 59.9 | 59.4 | 71.7 | 64.3 | 60.9 | 77.7 | 67.9 | 62.9 | 81.8 | 70.4 | 64.3 | 84.4 | 72.3 | 65.5 | 88 | 75 | 67.5 | 83.1 | 73.2 | 66.6 | 73.6 | 67.9 | 63.7 | 50 |
| 55 | 60.5 | 58.2 | 9.1 | 68 | 61.9 | 59.7 | 73.7 | 65.2 | 61.2 | 78 | 67.8 | 62.6 | 80.7 | 69.7 | 63.7 | 84.3 | 72.5 | 66 | 78.7 | 71 | 65.1 | 69.8 | 65.1 | 61.7 | 55 |
| 60 | | | | 64.7 | 59.9 | 32.6 | 70.2 | 63 | 59.9 | 74.4 | 65.6 | 61.2 | 77.2 | 67.3 | 62.2 | 81.2 | 70.2 | 64.4 | 73.8 | 69 | 63.8 | 66.1 | 62.3 | 59.3 | 60 |
| 65 | | | | 62.2 | 58.8 | 16 | 67.2 | 61.1 | 58.9 | 71.2 | 63.4 | 59.9 | 74.2 | 65.3 | 60.9 | 78.2 | 68.3 | 63.1 | 69.1 | 66.9 | 62.6 | 62.5 | 59.9 | 57.1 | 65 |
| 70 | | | | 59.3 | 57.5 | 9.5 | 64.5 | 59.6 | 47.6 | 68.4 | 61.7 | 59 | 71.4 | 63.5 | 59.8 | 74.8 | 66.5 | 61.9 | 64.9 | 64.3 | 61 | 59 | 57.5 | 55.1 | 70 |
| 75 | | | | 41.9 | | | 62.3 | 58.4 | 22.2 | 65.9 | 60.1 | 58.1 | 68.9 | 61.7 | 58.8 | 68.5 | 64.9 | 60.9 | 60.9 | 60.6 | 58.8 | 55.6 | 55.1 | 53.1 | 75 |
| 80 | | | | | | | 60.5 | 57.8 | 13.8 | 63.9 | 58.9 | 57.8 | 64.2 | 60.4 | 58 | 62.6 | 63 | 60.1 | 57.1 | 56.9 | 56.4 | 52.7 | 52.5 | 51.1 | 80 |
| 85 | | | | | | | 58.2 | 55.9 | 9.2 | 60.2 | 57.8 | 29 | 59 | 59 | 57.4 | 57.3 | 57.9 | 58 | 53.7 | 53.6 | 53.6 | 49.8 | 49.8 | 49 | 85 |
| 90 | | | | | | | 40.8 | 13.5 | | 55.6 | 55.9 | 18.1 | 54.4 | 54.8 | 55 | 52.7 | 53.3 | 53.5 | 51.4 | 50.4 | 50.5 | 47.2 | 47.2 | 46.9 | 90 |
| 95 | | | | | | | | | | 51.5 | 51.8 | 12.5 | 50.2 | 50.6 | 37.1 | 48.6 | 49.1 | 49.3 | 49.3 | 47.1 | 47.4 | 44.9 | 44.8 | 44.8 | 95 |
| 100 | | | | | | | | | | 47.9 | 44.9 | 9 | 46.6 | 46.9 | 22.6 | 44.9 | 45.3 | 45.5 | 46.2 | 45.1 | 44.3 | 42.6 | 42.6 | 42.6 | 100 |
| 105 | | | | | | | | | | 35.8 | 15.6 | 5.7 | 43.3 | 43.5 | 15.8 | 43.1 | 41.9 | 40.7 | 42.9 | 43.1 | 42.9 | 40.3 | 40.4 | 40.5 | 105 |
| 110 | | | | | | | | | | | | | 40.3 | 40.5 | 11.7 | 41.4 | 40.2 | 27.7 | 39.9 | 40.2 | 40.4 | 38.2 | 38.2 | 38.3 | 110 |
| 115 | | | | | | | | | | | | | 37.6 | 37.7 | 8.9 | 38.9 | 39 | 19.2 | 37.1 | 37.4 | 37.6 | 35.5 | 35.9 | 36.1 | 115 |
| 120 | | | | | | | | | | | | | 31 | 17 | 6.3 | 36.4 | 36.6 | 14.4 | 34.6 | 34.9 | 32.4 | 33 | 33.3 | 33.5 | 120 |
| 125 | | | | | | | | | | | | | | | | 34.1 | 34.3 | 11.2 | 32.3 | 32.5 | 22.8 | 31.3 | 31.4 | 31.5 | 125 |
| 130 | | | | | | | | | | | | | | | | 32 | 32.1 | 8.8 | 30.2 | 30.4 | 17.2 | 29.5 | 29.8 | 29.9 | 130 |
| 135 | | | | | | | | | | | | | | | | 25 | 18.2 | 6.6 | 28.2 | 28.3 | 13.5 | 27.5 | 27.7 | 26.7 | 135 |
| 140 | | | | | | | | | | | | | | | | | | | 26.3 | 26.4 | 10.8 | 25.6 | 25.8 | 20.1 | 140 |
| 145 | | | | | | | | | | | | | | | | | | | 24.6 | 24.7 | 8.7 | 23.8 | 24 | 15.8 | 145 |
| 150 | | | | | | | | | | | | | | | | | | | 20.7 | 19 | 6.9 | 22.2 | 22.4 | 12.7 | 150 |
| 155 | | | | | | | | | | | | | | | | | | | | | | 20.7 | 20.9 | 10.5 | 155 |
| 160 | | | | | | | | | | | | | | | | | | | | | | 19.4 | 19.4 | 8.6 | 160 |
| 165 | | | | | | | | | | | | | | | | | | | | | | 16.4 | 16.4 | 7 | 165 |
| 170 | | | | | | | | | | | | | | | | | | | | | | 10.5 | 9.4 | | 170 |

†_240_002_50001_00_000 / 52001_00_000 / 54001_00_000

Lifting capacities Forces de levage

TK

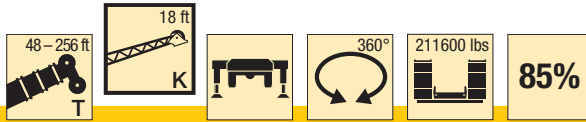

| ft | 176 ft | | | 192 ft | | | 208 ft | | | 224 ft | | | 240 ft | | | 253 ft | | | 256 ft | | | ft | |
|-----|--------|------|------|--------|------|------|--------|------|------|--------|------|------|--------|------|------|--------|------|------|--------|------|------|------|----|
| | 18 ft | | | 18 ft | | | 18 ft | | | 18 ft | | | 18 ft | | | 18 ft | | | | | | | |
| | 0° | 20° | 40° | 0° | 20° | 40° | 0° | 20° | 40° | 0° | 20° | 40° | 0° | 20° | 40° | 0° | 20° | 40° | 0° | 20° | 40° | | |
| 34 | 64.7 | | | | | | | | | | | | | | | | | | | | | 34 | |
| 36 | 64.5 | | | | | | | | | | | | | | | | | | | | | | 36 |
| 38 | 64.2 | 64.7 | | 51.5 | | | | | | | | | | | | | | | | | | | 38 |
| 40 | 64 | 64.5 | | 51.3 | | | | | | | | | | | | | | | | | | | 40 |
| 45 | 63.2 | 63.7 | 61 | 50.8 | 51.2 | 51.4 | 41.6 | | | | | | | | | | | | | | | | 45 |
| 50 | 62.2 | 62.8 | 60 | 50.3 | 50.7 | 51.2 | 41.2 | 41.5 | 42.2 | 34 | | | 25.4 | | | | | | | | | | 50 |
| 55 | 60.7 | 60.6 | 58.7 | 49.7 | 50 | 50.5 | 40.9 | 41.2 | 41.3 | 33.8 | 33.8 | 34.1 | 25.3 | 25.4 | | 21 | | | | 20.4 | | | 55 |
| 60 | 57.9 | 57.8 | 56.7 | 48.7 | 48.8 | 49 | 40.3 | 40.1 | 40.2 | 33.2 | 33.2 | 33.5 | 25.1 | 25.2 | 25.1 | 21 | 21 | | | 20.3 | 20.4 | | 60 |
| 65 | 55 | 54.9 | 54.4 | 46.9 | 47 | 47.2 | 39.1 | 38.9 | 39 | 32.5 | 32.4 | 32.6 | 24.9 | 24.9 | 25 | 20.9 | 20.9 | 20.9 | | 20.4 | 20.4 | 20.3 | 65 |
| 70 | 52.2 | 52.2 | 52.1 | 44.9 | 45 | 45.3 | 37.9 | 37.7 | 37.7 | 31.6 | 31.4 | 31.5 | 24.6 | 24.5 | 24.6 | 20.7 | 20.7 | 20.8 | 20.2 | 20.3 | 20.3 | 70 | |
| 75 | 49.6 | 49.5 | 49.7 | 43 | 43.1 | 43.3 | 36.6 | 36.4 | 36.3 | 30.6 | 30.3 | 30.4 | 24.1 | 24 | 24.1 | 20.4 | 20.3 | 20.4 | 20 | 20 | 20.1 | 75 | |
| 80 | 46.9 | 47 | 47.1 | 41.1 | 41.1 | 41.4 | 35.3 | 35 | 34.9 | 29.5 | 29.3 | 29.3 | 23.5 | 23.4 | 23.5 | 19.9 | 19.9 | 19.9 | 19.6 | 19.6 | 19.6 | 80 | |
| 85 | 44.4 | 44.4 | 44.6 | 39.2 | 39.2 | 39.5 | 34 | 33.7 | 33.6 | 28.5 | 28.3 | 28.3 | 22.8 | 22.8 | 22.8 | 19.4 | 19.3 | 19.4 | 19.1 | 19.1 | 19.1 | 85 | |
| 90 | 42.1 | 42.1 | 42.3 | 37.3 | 37.4 | 37.6 | 32.7 | 32.4 | 32.3 | 27.5 | 27.3 | 27.3 | 22.2 | 22.1 | 22.2 | 18.8 | 18.7 | 18.8 | 18.6 | 18.5 | 18.5 | 90 | |
| 95 | 39.8 | 40 | 40.1 | 35.5 | 35.6 | 35.8 | 31.4 | 31.2 | 31.1 | 26.6 | 26.3 | 26.3 | 21.5 | 21.4 | 21.5 | 18.2 | 18.1 | 18.2 | 18 | 17.9 | 18 | 95 | |
| 100 | 37.7 | 37.8 | 38 | 33.8 | 33.9 | 34.1 | 30.1 | 30 | 29.9 | 25.6 | 25.4 | 25.4 | 20.9 | 20.7 | 20.8 | 17.6 | 17.5 | 17.6 | 17.4 | 17.4 | 17.4 | 100 | |
| 105 | 35.9 | 35.9 | 36 | 32.1 | 32.2 | 32.5 | 28.9 | 28.8 | 28.8 | 24.7 | 24.5 | 24.5 | 20.2 | 20.1 | 20.1 | 17 | 16.9 | 17 | 16.8 | 16.8 | 16.8 | 105 | |
| 110 | 34 | 34.2 | 34.3 | 30.6 | 30.6 | 30.9 | 27.6 | 27.6 | 27.6 | 23.7 | 23.6 | 23.6 | 19.5 | 19.4 | 19.5 | 16.5 | 16.4 | 16.4 | 16.3 | 16.2 | 16.3 | 110 | |
| 115 | 32.2 | 32.4 | 32.5 | 29.1 | 29.2 | 29.4 | 26.3 | 26.4 | 26.5 | 22.9 | 22.7 | 22.7 | 18.9 | 18.8 | 18.8 | 15.9 | 15.8 | 15.9 | 15.8 | 15.7 | 15.7 | 115 | |
| 120 | 30.6 | 30.7 | 30.8 | 27.7 | 27.8 | 28 | 25.1 | 25.2 | 25.3 | 22.1 | 21.9 | 21.9 | 18.2 | 18.1 | 18.2 | 15.4 | 15.3 | 15.4 | 15.3 | 15.2 | 15.2 | 120 | |
| 125 | 29.1 | 29.2 | 29.3 | 26.3 | 26.5 | 26.6 | 24 | 24 | 24.2 | 21.3 | 21.2 | 21.2 | 17.6 | 17.5 | 17.6 | 14.8 | 14.8 | 14.8 | 14.7 | 14.7 | 14.7 | 125 | |
| 130 | 27.7 | 27.7 | 27.9 | 25 | 25.2 | 25.3 | 22.9 | 23 | 23.1 | 20.5 | 20.4 | 20.4 | 17.1 | 17 | 17 | 14.3 | 14.3 | 14.3 | 14.3 | 14.2 | 14.2 | 130 | |
| 135 | 25.8 | 26.1 | 26.3 | 23.8 | 23.9 | 24 | 21.8 | 22 | 22.1 | 19.7 | 19.6 | 19.7 | 16.5 | 16.4 | 16.5 | 13.8 | 13.8 | 13.8 | 13.8 | 13.7 | 13.8 | 135 | |
| 140 | 23.9 | 24.2 | 24.4 | 22.7 | 22.8 | 22.9 | 20.8 | 20.9 | 21 | 19 | 18.9 | 19 | 15.9 | 15.9 | 15.9 | 13.4 | 13.4 | 13.4 | 13.3 | 13.3 | 13.3 | 140 | |
| 145 | 22.9 | 22.9 | 23 | 21.5 | 21.7 | 21.8 | 19.8 | 19.9 | 20 | 18.2 | 18.2 | 18.3 | 15.4 | 15.4 | 15.4 | 12.9 | 12.9 | 12.9 | 12.9 | 12.8 | 12.9 | 145 | |
| 150 | 21.9 | 21.9 | 22 | 20.5 | 20.6 | 20.7 | 18.9 | 19 | 19.1 | 17.5 | 17.5 | 17.6 | 15 | 14.9 | 14.9 | 12.5 | 12.5 | 12.5 | 12.4 | 12.4 | 12.4 | 150 | |
| 155 | 20.6 | 20.8 | 18.2 | 19.2 | 19.5 | 19.6 | 17.9 | 18.1 | 18.2 | 16.7 | 16.8 | 16.9 | 14.5 | 14.4 | 14.5 | 12.1 | 12.1 | 12.1 | 12 | 12 | 12 | 155 | |
| 160 | 19.2 | 19.3 | 14.7 | 17.8 | 18.1 | 18.1 | 17.1 | 17.2 | 17.3 | 16 | 16.1 | 16.2 | 14 | 14 | 14 | 11.7 | 11.7 | 11.7 | 11.7 | 11.6 | 11.7 | 160 | |
| 165 | 17.8 | 18 | 12.2 | 17 | 17.1 | 17.1 | 16.2 | 16.3 | 16.4 | 15.3 | 15.4 | 15.4 | 13.6 | 13.5 | 13.6 | 11.3 | 11.3 | 11.3 | 11.3 | 11.3 | 11.3 | 165 | |
| 170 | 16.6 | 16.7 | 10.2 | 16.3 | 16.3 | 16.4 | 15.4 | 15.6 | 15.6 | 14.6 | 14.6 | 14.7 | 13.1 | 13.1 | 13.1 | 10.9 | 10.9 | 11 | 10.9 | 10.9 | 10.9 | 170 | |
| 175 | 15.5 | 15.6 | 8.6 | 15.7 | 15.7 | 13.9 | 14.5 | 14.7 | 14.7 | 13.8 | 13.9 | 14 | 12.7 | 12.7 | 12.7 | 10.6 | 10.6 | 10.6 | 10.6 | 10.6 | 10.6 | 175 | |
| 180 | 13.1 | 13.2 | 7.1 | 14.8 | 14.9 | 11.8 | 13.5 | 13.5 | 13.6 | 13.2 | 13.3 | 13.3 | 12.3 | 12.3 | 12.3 | 10.2 | 10.2 | 10.2 | 10.2 | 10.2 | 10.2 | 180 | |
| 185 | 9.3 | 9.1 | | 13.8 | 13.9 | 10 | 12.9 | 12.9 | 13 | 12.6 | 12.7 | 12.7 | 11.9 | 11.9 | 11.9 | 9.8 | 9.8 | 9.9 | 9.7 | 9.8 | 9.8 | 185 | |
| 190 | | | | 12.8 | 12.9 | 8.6 | 12.4 | 12.5 | 12.5 | 11.4 | 11.4 | 11.5 | 11.5 | 11.5 | 11.6 | 9.5 | 9.5 | 9.5 | 9.2 | 9.3 | 9.3 | 190 | |
| 195 | | | | 10.7 | 10.7 | 7.2 | 11.9 | 12 | 11.4 | 10.9 | 11 | 11 | 11 | 11 | 11.1 | 9.1 | 9.1 | 9.2 | 8.8 | 8.8 | 8.9 | 195 | |
| 200 | | | | 7.7 | 7.7 | 5.1 | 11.4 | 11.4 | 9.9 | 9.4 | 9.7 | 9.8 | 10.5 | 10.6 | 10.6 | 8.8 | 8.8 | 8.9 | 8.3 | 8.4 | 8.4 | 200 | |
| 205 | | | | | | | 9.8 | 9.9 | 8.5 | 7.5 | 7.9 | 7.8 | 10 | 10.1 | 10.1 | 8.5 | 8.5 | 8.5 | 7.9 | 7.9 | 8 | 205 | |
| 210 | | | | | | | 8.8 | 8.8 | 7.3 | 5.7 | 6 | 6 | 9.5 | 9.6 | 9.6 | 8.1 | 8.2 | 8.2 | 7.5 | 7.5 | 7.5 | 210 | |
| 215 | | | | | | | 5.7 | 5.8 | 4.2 | 4 | 4.3 | 4.2 | 8.8 | 8.9 | 8.9 | 7.8 | 7.9 | 7.9 | 7.1 | 7.1 | 7.1 | 215 | |
| 220 | | | | | | | | | | 2.4 | 2.6 | 2.3 | 8.1 | 8.2 | 8.2 | 7.5 | 7.6 | 7.6 | 6.7 | 6.7 | 6.7 | 220 | |
| 225 | | | | | | | | | | | | | 7.4 | 7.5 | 7.5 | 7.2 | 7.2 | 7.3 | 6.3 | 6.3 | 6.3 | 225 | |
| 230 | | | | | | | | | | | | | 6.9 | 6.9 | 6.9 | 6.9 | 7 | 7 | 5.9 | 5.9 | 6 | 230 | |
| 235 | | | | | | | | | | | | | 6.4 | 6.4 | 6.4 | 6.5 | 6.5 | 6.5 | 5.6 | 5.6 | 5.6 | 235 | |
| 240 | | | | | | | | | | | | | 4.6 | 4.8 | 4.3 | 5.9 | 6 | 6 | 5.2 | 5.2 | 5.2 | 240 | |
| 245 | | | | | | | | | | | | | | | | 5.3 | 5.3 | 5.3 | 4.9 | 4.8 | 4.8 | 245 | |
| 250 | | | | | | | | | | | | | | | | 4.4 | 4.6 | 4.3 | 4.4 | 4.4 | 4.4 | 250 | |
| 255 | | | | | | | | | | | | | | | | | 2.1 | | 2.8 | 3 | 2.6 | 255 | |

t_240_002_50001_00_000 / 52001_00_000 / 54001_00_000

Lifting capacities Forces de levage

TK

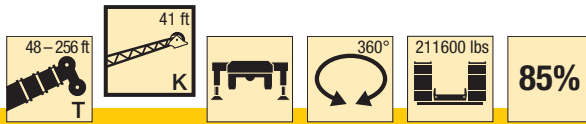

| ft | 48 ft | | | 144 ft | | | 160 ft | | | 176 ft | | | 192 ft | | | ft |
|-----|-------|------|------|--------|------|------|--------|------|------|--------|------|------|--------|------|------|-----|
| | 41 ft | | | 41 ft | | | 41 ft | | | 41 ft | | | 41 ft | | | |
| | 0° | 20° | 40° | 0° | 20° | 40° | 0° | 20° | 40° | 0° | 20° | 40° | 0° | 20° | 40° | |
| 12 | 52.4 | | | | | | | | | | | | | | | 12 |
| 13 | 52.1 | | | | | | | | | | | | | | | 13 |
| 14 | 51.7 | | | | | | | | | | | | | | | 14 |
| 15 | 51.2 | | | | | | | | | | | | | | | 15 |
| 16 | 50.7 | | | | | | | | | | | | | | | 16 |
| 17 | 50.1 | | | | | | | | | | | | | | | 17 |
| 18 | 49.5 | | | | | | | | | | | | | | | 18 |
| 19 | 48.9 | 39.2 | | | | | | | | | | | | | | 19 |
| 20 | 48.3 | 39 | | | | | | | | | | | | | | 20 |
| 22 | 47.1 | 37.2 | | | | | | | | | | | | | | 22 |
| 24 | 45.8 | 35.3 | | 52.7 | | | | | | | | | | | | 24 |
| 26 | 44.3 | 33.6 | | 52.8 | | | | | | | | | | | | 26 |
| 28 | 42.9 | 32.1 | 23.1 | 52.8 | | | 47.4 | | | | | | | | | 28 |
| 30 | 41.4 | 30.8 | 22.8 | 52.6 | | | 47.4 | | | | | | | | | 30 |
| 32 | 40.1 | 29.5 | 22.1 | 52.4 | | | 47.4 | | | 41.7 | | | | | | 32 |
| 34 | 38.8 | 28.5 | 21.6 | 52 | | | 47.3 | | | 41.6 | | | | | | 34 |
| 36 | 37.5 | 27.4 | 21.1 | 51.6 | | | 47.1 | | | 41.6 | | | 35.6 | | | 36 |
| 38 | 36.3 | 26.4 | 20.6 | 51.2 | 38.4 | | 46.7 | | | 41.5 | | | 35.7 | | | 38 |
| 40 | 34.9 | 25.6 | 20.2 | 50.7 | 37.5 | | 46.3 | | | 41.3 | | | 35.7 | | | 40 |
| 45 | 31.2 | 23.6 | 19.2 | 49.3 | 35.2 | 23.1 | 45.4 | 36.1 | | 40.7 | | | 35.5 | | | 45 |
| 50 | 28 | 22.1 | 18.4 | 47.8 | 33.3 | 22.3 | 44.5 | 34.1 | 22.5 | 40.1 | 34.5 | | 35.2 | | | 50 |
| 55 | 25.4 | 20.8 | 17.8 | 46.3 | 31.6 | 21.7 | 43.5 | 32.3 | 21.9 | 39.5 | 32.9 | 22 | 34.8 | 31.8 | | 55 |
| 60 | 23.4 | 19.6 | 17.4 | 44.6 | 30 | 21.1 | 42.6 | 30.8 | 21.3 | 38.8 | 31.3 | 21.4 | 34.4 | 31 | 21.5 | 60 |
| 65 | 21.6 | 18.7 | 17.1 | 42.8 | 28.7 | 20.6 | 41.4 | 29.5 | 20.8 | 38.2 | 29.9 | 20.9 | 34 | 30.1 | 20.9 | 65 |
| 70 | 20.1 | 18 | 17.1 | 41.1 | 27.5 | 20.1 | 40.1 | 28.3 | 20.3 | 37.5 | 28.7 | 20.5 | 33.6 | 28.8 | 20.5 | 70 |
| 75 | 18.8 | 17.6 | 16.3 | 39.5 | 26.4 | 19.6 | 38.8 | 27.2 | 19.9 | 36.7 | 27.5 | 20 | 33.1 | 27.7 | 20.1 | 75 |
| 80 | 17.8 | 17.5 | | 38 | 25.4 | 19.2 | 37.6 | 26.2 | 19.5 | 35.8 | 26.6 | 19.7 | 32.7 | 26.7 | 19.7 | 80 |
| 85 | | | | 36.5 | 24.5 | 18.9 | 36.4 | 25.2 | 19.1 | 34.9 | 25.7 | 19.3 | 32 | 25.8 | 19.4 | 85 |
| 90 | | | | 34.8 | 23.6 | 18.6 | 35.2 | 24.4 | 18.8 | 34 | 24.8 | 19 | 31.4 | 25 | 19.1 | 90 |
| 95 | | | | 33 | 22.9 | 18.3 | 34.1 | 23.6 | 18.5 | 33.1 | 24 | 18.7 | 30.7 | 24.3 | 18.8 | 95 |
| 100 | | | | 31.3 | 22.2 | 18 | 32.9 | 22.9 | 18.2 | 32.3 | 23.3 | 18.4 | 29.9 | 23.5 | 18.5 | 100 |
| 105 | | | | 29.6 | 21.5 | 17.8 | 31.4 | 22.3 | 18 | 31.5 | 22.7 | 18.1 | 29 | 22.9 | 18.2 | 105 |
| 110 | | | | 28.2 | 20.9 | 17.6 | 30 | 21.6 | 17.8 | 30.5 | 22.1 | 17.9 | 27.8 | 22.3 | 18 | 110 |
| 115 | | | | 26.9 | 20.4 | 17.4 | 28.6 | 21 | 17.6 | 29.4 | 21.5 | 17.7 | 26.5 | 21.7 | 17.8 | 115 |
| 120 | | | | 25.7 | 19.9 | 17.3 | 27.3 | 20.6 | 17.4 | 28.2 | 21 | 17.5 | 25.4 | 21.1 | 17.6 | 120 |
| 125 | | | | 24.6 | 19.4 | 17.2 | 26.3 | 20.1 | 17.3 | 27 | 20.5 | 17.4 | 24.3 | 20.7 | 17.4 | 125 |
| 130 | | | | 23.7 | 19 | 17.1 | 25.2 | 19.6 | 17.1 | 25.9 | 20.1 | 17.2 | 23.2 | 20.3 | 17.3 | 130 |
| 135 | | | | 22.8 | 18.6 | 17.1 | 24.2 | 19.2 | 17.1 | 24.7 | 19.7 | 17.2 | 22.2 | 19.9 | 17.2 | 135 |
| 140 | | | | 21.9 | 18.3 | 17.1 | 23.3 | 18.9 | 17 | 23.6 | 19.3 | 17.1 | 21.2 | 19.5 | 17.1 | 140 |
| 145 | | | | 21.1 | 18 | 15.7 | 22.6 | 18.6 | 17 | 22.6 | 18.9 | 17 | 20.2 | 19.1 | 17.1 | 145 |
| 150 | | | | 20.4 | 17.8 | 10.1 | 21.8 | 18.2 | 17 | 21.5 | 18.6 | 17 | 19.3 | 18.7 | 17 | 150 |
| 155 | | | | 19.7 | 17.6 | 7.2 | 21 | 18 | 16.5 | 20.4 | 18.4 | 17 | 18.4 | 18.3 | 17 | 155 |
| 160 | | | | 19.1 | 17.5 | 5.4 | 20.4 | 17.8 | 12.4 | 19 | 18.1 | 17 | 17.5 | 17.8 | 16.8 | 160 |
| 165 | | | | 18.6 | 17.5 | | 19.4 | 17.6 | 8.7 | 17.7 | 17.8 | 17 | 16.7 | 17.1 | 16.6 | 165 |
| 170 | | | | 17.2 | 16 | | 18.1 | 17.5 | 6.6 | 17 | 17.1 | 15.1 | 16 | 16.4 | 16.4 | 170 |
| 175 | | | | 10.2 | 6.9 | | 17 | 17.4 | 5.1 | 16.3 | 16.5 | 10.5 | 15 | 15.6 | 15.8 | 175 |
| 180 | | | | | | | 15.9 | 16.3 | | 15.5 | 15.8 | 7.8 | 14 | 14.7 | 15 | 180 |
| 185 | | | | | | | 13.3 | 15.2 | | 14.5 | 15 | 6.1 | 13.1 | 13.6 | 12.2 | 185 |
| 190 | | | | | | | 7.7 | 7.5 | | 13.6 | 14 | 4.9 | 12.6 | 12.7 | 9.1 | 190 |
| 195 | | | | | | | | | | 12.7 | 13 | | 12.1 | 12.2 | 7.2 | 195 |
| 200 | | | | | | | | | | 10.4 | 12.1 | | 11.6 | 11.7 | 5.8 | 200 |
| 205 | | | | | | | | | | 6.1 | 7.8 | | 11 | 11.3 | | 205 |
| 210 | | | | | | | | | | | | | 10.3 | 10.6 | | 210 |
| 215 | | | | | | | | | | | | | 8.3 | 9.8 | | 215 |
| 220 | | | | | | | | | | | | | 7.1 | 7.2 | | 220 |

t_240_002_50101_00_000 / 52101_00_000 / 54101_00_000

Lifting capacities Forces de levage

TK



| ft | 208 ft | | | 224 ft | | | 240 ft | | | 253 ft | | | 256 ft | | | ft |
|-----|--------|------|------|--------|------|------|--------|------|------|--------|------|------|--------|------|------|-----|
| | 41 ft | | | 41 ft | | | 41 ft | | | 41 ft | | | 41 ft | | | |
| | 0° | 20° | 40° | 0° | 20° | 40° | 0° | 20° | 40° | 0° | 20° | 40° | 0° | 20° | 40° | |
| 45 | 30 | | | 23.3 | | | | | | | | | | | | 45 |
| 50 | 30.1 | | | 23.5 | | | 19.4 | | | | | | | | | 50 |
| 55 | 29.9 | | | 23.6 | | | 19.4 | | | 16.4 | | | 15.9 | | | 55 |
| 60 | 29.7 | 28.3 | | 23.8 | | | 19.4 | | | 16.4 | | | 15.9 | | | 60 |
| 65 | 29.5 | 27.8 | 20.9 | 23.9 | 23.9 | | 19.3 | | | 16.4 | | | 16 | | | 65 |
| 70 | 29.3 | 27.3 | 22.6 | 23.8 | 23.7 | | 19.2 | 19.2 | | 16.3 | | | 15.9 | | | 70 |
| 75 | 28.9 | 26.9 | 22 | 23.6 | 23.3 | 22.5 | 19.1 | 18.8 | | 16.1 | 16 | | 15.8 | 15.7 | | 75 |
| 80 | 28.5 | 26.4 | 21.5 | 23.2 | 22.8 | 22.1 | 18.9 | 18.4 | 17.8 | 15.9 | 15.8 | | 15.6 | 15.5 | | 80 |
| 85 | 28.1 | 25.6 | 21.1 | 22.6 | 22.3 | 21.6 | 18.7 | 17.9 | 17.4 | 15.7 | 15.5 | 15.1 | 15.4 | 15.2 | 15 | 85 |
| 90 | 27.4 | 24.8 | 20.8 | 22.1 | 21.7 | 21.2 | 18.2 | 17.5 | 16.9 | 15.5 | 15.1 | 14.7 | 15.2 | 15 | 14.6 | 90 |
| 95 | 26.7 | 24.1 | 20.5 | 21.5 | 21.1 | 20.7 | 17.9 | 17 | 16.4 | 15.1 | 14.8 | 14.4 | 14.9 | 14.6 | 14.2 | 95 |
| 100 | 25.8 | 23.4 | 20.2 | 20.8 | 20.4 | 20.3 | 17.4 | 16.6 | 16 | 14.7 | 14.4 | 14 | 14.5 | 14.3 | 13.9 | 100 |
| 105 | 24.9 | 22.8 | 19.9 | 20.2 | 19.8 | 19.7 | 17 | 16.1 | 15.6 | 14.3 | 14.1 | 13.7 | 14.1 | 13.9 | 13.6 | 105 |
| 110 | 24 | 22.2 | 19.4 | 19.5 | 19.1 | 19.1 | 16.5 | 15.7 | 15.2 | 13.9 | 13.7 | 13.4 | 13.8 | 13.6 | 13.3 | 110 |
| 115 | 23.2 | 21.7 | 18.8 | 18.9 | 18.5 | 18.5 | 16.1 | 15.3 | 14.9 | 13.5 | 13.3 | 13 | 13.4 | 13.2 | 12.9 | 115 |
| 120 | 22.4 | 21.1 | 18.2 | 18.2 | 17.9 | 17.9 | 15.6 | 14.9 | 14.5 | 13.1 | 12.9 | 12.7 | 12.9 | 12.8 | 12.6 | 120 |
| 125 | 21.5 | 20.7 | 17.6 | 17.6 | 17.3 | 17.3 | 15.1 | 14.6 | 14.2 | 12.6 | 12.5 | 12.4 | 12.5 | 12.4 | 12.3 | 125 |
| 130 | 20.7 | 20.1 | 17.3 | 17 | 16.8 | 16.7 | 14.6 | 4.2 | 13.9 | 12.2 | 12.1 | 12.1 | 12.1 | 12 | 12.1 | 130 |
| 135 | 19.9 | 19.6 | 17.2 | 16.4 | 16.2 | 16.2 | 14.1 | 13.8 | 13.5 | 11.8 | 11.7 | 11.8 | 11.7 | 11.6 | 11.7 | 135 |
| 140 | 19.1 | 19 | 17.1 | 15.9 | 15.7 | 15.7 | 13.7 | 13.4 | 13.2 | 11.4 | 11.3 | 11.4 | 11.3 | 11.2 | 11.4 | 140 |
| 145 | 18.3 | 18.3 | 17.1 | 15.4 | 15.2 | 15.2 | 13.2 | 13 | 12.9 | 11 | 10.9 | 11 | 10.9 | 10.9 | 11 | 145 |
| 150 | 17.5 | 17.7 | 17 | 14.9 | 14.7 | 14.7 | 12.8 | 12.7 | 12.6 | 10.6 | 10.6 | 10.7 | 10.6 | 10.5 | 10.6 | 150 |
| 155 | 16.7 | 17.1 | 16.8 | 14.4 | 14.3 | 14.3 | 12.4 | 12.3 | 12.3 | 10.3 | 10.2 | 10.3 | 10.2 | 10.2 | 10.3 | 155 |
| 160 | 16 | 16.4 | 16.3 | 13.9 | 13.8 | 13.8 | 12 | 11.9 | 12 | 9.9 | 9.9 | 10 | 9.8 | 9.8 | 9.9 | 160 |
| 165 | 15.3 | 15.6 | 15.7 | 13.5 | 13.3 | 13.4 | 11.6 | 11.6 | 11.6 | 9.6 | 9.5 | 9.6 | 9.5 | 9.5 | 9.6 | 165 |
| 170 | 14.6 | 14.9 | 15.2 | 13 | 12.9 | 13 | 11.2 | 11.2 | 11.3 | 9.2 | 9.2 | 9.3 | 9.2 | 9.2 | 9.3 | 170 |
| 175 | 13.9 | 14.2 | 14.5 | 12.5 | 12.5 | 12.6 | 10.9 | 10.8 | 10.9 | 8.9 | 8.9 | 9 | 8.9 | 8.9 | 9 | 175 |
| 180 | 13.2 | 13.6 | 13.9 | 12.1 | 12.1 | 12.2 | 10.5 | 10.5 | 10.6 | 8.6 | 8.6 | 8.7 | 8.6 | 8.6 | 8.7 | 180 |
| 185 | 12.6 | 13 | 13.2 | 11.6 | 11.7 | 11.8 | 10.2 | 10.2 | 10.3 | 8.3 | 8.3 | 8.4 | 8.3 | 8.3 | 8.4 | 185 |
| 190 | 12 | 12.3 | 12.6 | 11.1 | 11.3 | 11.5 | 9.8 | 9.8 | 9.9 | 8 | 8 | 8.1 | 8 | 8 | 8.1 | 190 |
| 195 | 11.2 | 11.7 | 11.9 | 10.7 | 10.9 | 11.1 | 9.5 | 9.5 | 9.6 | 7.8 | 7.8 | 7.9 | 7.7 | 7.8 | 7.9 | 195 |
| 200 | 10.3 | 11 | 10.7 | 10.2 | 10.4 | 10.7 | 9.2 | 9.2 | 9.3 | 7.5 | 7.5 | 7.6 | 7.4 | 7.5 | 7.6 | 200 |
| 205 | 9.8 | 10.1 | 8.3 | 9.7 | 10 | 10.2 | 8.9 | 8.9 | 9 | 7.3 | 7.3 | 7.4 | 7.1 | 7.3 | 7.4 | 205 |
| 210 | 9.5 | 9.5 | 6.7 | 9.2 | 9.5 | 9.7 | 8.6 | 8.7 | 8.8 | 7.1 | 7 | 7.1 | 6.8 | 7.1 | 7.1 | 210 |
| 215 | 9.1 | 9.2 | 5.5 | 8.7 | 9 | 9.2 | 8.3 | 8.4 | 8.5 | 6.8 | 6.8 | 6.9 | 6.5 | 6.8 | 6.8 | 215 |
| 220 | 8.7 | 8.8 | | 7.9 | 8.4 | 7.6 | 7.9 | 8.1 | 8.2 | 6.6 | 6.6 | 6.7 | 6.2 | 6.4 | 6.5 | 220 |
| 225 | 8.4 | 8.5 | | 7.6 | 7.7 | 6.3 | 7.6 | 7.8 | 7.9 | 6.4 | 6.4 | 6.5 | 5.9 | 6.1 | 6.2 | 225 |
| 230 | 7 | 8.2 | | 7.4 | 7.4 | 5.3 | 7.2 | 7.5 | 7.6 | 6.2 | 6.2 | 6.3 | 5.5 | 5.7 | 5.9 | 230 |
| 235 | 5.6 | 6.6 | | 7.1 | 7.2 | | 6.8 | 7.1 | 7 | 6 | 6 | 6.1 | 5.1 | 5.4 | 5.5 | 235 |
| 240 | | | | 6.9 | 6.9 | | 6.3 | 6.6 | 6 | 5.8 | 5.8 | 5.9 | 4.8 | 5 | 5.1 | 240 |
| 245 | | | | 6.1 | 6.8 | | 5.8 | 6.1 | 5.1 | 5.5 | 5.6 | 5.7 | 4.4 | 4.7 | 4.7 | 245 |
| 250 | | | | 3.5 | 4.8 | | 5.1 | 5.5 | | 5.2 | 5.4 | 5.5 | 4.1 | 4.3 | 4.4 | 250 |
| 255 | | | | | | | 4.6 | 4.9 | | 4.6 | 5 | 5.1 | 3.8 | 4 | 4 | 255 |
| 260 | | | | | | | 3.2 | 4.3 | | 4 | 4.4 | | 3.5 | 3.7 | 3.7 | 260 |
| 265 | | | | | | | | | | 3.4 | 3.8 | | 3.2 | 3.4 | | 265 |
| 270 | | | | | | | | | | 2.8 | 3.2 | | 2.7 | 3 | | 270 |
| 275 | | | | | | | | | | | | | | 2.4 | | 275 |

t_240_002_50101_00_000 / 52101_00_000 / 54101_00_000

Lifting capacities Forces de levage

TK

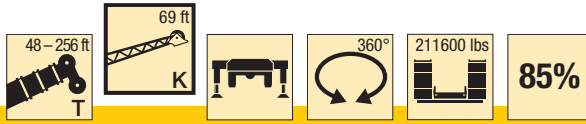

| ft | 48 ft | | | 144 ft | | | 160 ft | | | 176 ft | | | 192 ft | | | ft |
|-----|-------|------|------|--------|------|------|--------|------|------|--------|------|------|--------|------|------|-----|
| | 69 ft | | | 69 ft | | | 69 ft | | | 69 ft | | | 69 ft | | | |
| | 0° | 20° | 40° | 0° | 20° | 40° | 0° | 20° | 40° | 0° | 20° | 40° | 0° | 20° | 40° | |
| 12 | 20.8 | | | | | | | | | | | | | | | 12 |
| 13 | 20.8 | | | | | | | | | | | | | | | 13 |
| 14 | 20.9 | | | | | | | | | | | | | | | 14 |
| 15 | 21 | | | | | | | | | | | | | | | 15 |
| 16 | 21 | | | | | | | | | | | | | | | 16 |
| 17 | 21 | | | | | | | | | | | | | | | 17 |
| 18 | 21 | | | | | | | | | | | | | | | 18 |
| 19 | 21 | | | | | | | | | | | | | | | 19 |
| 20 | 21 | | | | | | | | | | | | | | | 20 |
| 22 | 21 | | | | | | | | | | | | | | | 22 |
| 24 | 20.9 | | | | | | | | | | | | | | | 24 |
| 26 | 20.7 | | | | | | | | | | | | | | | 26 |
| 28 | 20.5 | | | 20.8 | | | | | | | | | | | | 28 |
| 30 | 20.3 | | | 20.9 | | | 19.9 | | | | | | | | | 30 |
| 32 | 20 | | | 21 | | | 19.9 | | | | | | | | | 32 |
| 34 | 19.7 | 17.8 | | 21 | | | 19.9 | | | 18.7 | | | | | | 34 |
| 36 | 19.4 | 17.5 | | 21 | | | 19.9 | | | 18.7 | | | | | | 36 |
| 38 | 19.1 | 17.2 | | 21 | | | 19.9 | | | 18.8 | | 17.4 | | | | 38 |
| 40 | 18.7 | 16.9 | | 21 | | | 19.9 | | | 18.8 | | 17.4 | | | | 40 |
| 45 | 17.9 | 16.1 | | 21 | | | 19.9 | | | 18.8 | | 17.5 | | | | 45 |
| 50 | 17.1 | 15.4 | | 20.8 | | | 19.9 | | | 18.8 | | 17.5 | | | | 50 |
| 55 | 16.3 | 14.7 | 13.2 | 20.5 | 17.5 | | 19.8 | 17.2 | | 18.8 | | 17.5 | | | | 55 |
| 60 | 15.5 | 14.1 | 12.8 | 20.3 | 17 | | 19.6 | 16.8 | | 18.7 | 16.3 | 17.5 | | | | 60 |
| 65 | 14.8 | 13.6 | 12.4 | 19.9 | 16.7 | | 19.3 | 16.4 | | 18.5 | 16 | 17.3 | 15.2 | | | 65 |
| 70 | 14.2 | 13.1 | 12 | 19.5 | 16.2 | 13.4 | 19 | 16 | | 18.2 | 15.6 | 17.1 | 15 | | | 70 |
| 75 | 13.6 | 12.6 | 11.8 | 19 | 15.8 | 13.2 | 18.6 | 15.6 | 13.1 | 17.9 | 15.3 | 16.8 | 14.7 | | | 75 |
| 80 | 13.1 | 12.3 | 11.6 | 18.6 | 15.4 | 13 | 18.2 | 15.3 | 12.9 | 17.6 | 15 | 12.7 | 16.6 | 14.4 | | 80 |
| 85 | 12.6 | 12 | 11.4 | 18.1 | 15.1 | 12.8 | 17.8 | 15 | 12.7 | 17.2 | 14.7 | 12.5 | 16.3 | 14.2 | 12.2 | 85 |
| 90 | 12.1 | 11.7 | 11.4 | 17.7 | 14.7 | 12.6 | 17.4 | 14.6 | 12.5 | 16.9 | 14.4 | 12.3 | 16 | 13.9 | 12.1 | 90 |
| 95 | 11.6 | 11.5 | 11.4 | 17.2 | 14.4 | 12.4 | 17 | 14.3 | 12.3 | 16.5 | 14.1 | 12.2 | 15.7 | 13.7 | 11.9 | 95 |
| 100 | 11.1 | 11.4 | 11.4 | 16.7 | 14.1 | 12.2 | 16.6 | 14.1 | 12.2 | 16.2 | 13.9 | 12 | 15.4 | 13.4 | 11.8 | 100 |
| 105 | 10.6 | 11.3 | 4.5 | 16.3 | 13.8 | 12.1 | 16.2 | 13.8 | 12 | 15.8 | 13.6 | 11.9 | 15.1 | 13.2 | 11.7 | 105 |
| 110 | 9.8 | | | 15.9 | 13.5 | 11.9 | 15.8 | 13.5 | 11.9 | 15.5 | 13.4 | 11.7 | 14.9 | 13 | 11.5 | 110 |
| 115 | | | | 15.5 | 13.3 | 11.8 | 15.5 | 13.3 | 11.8 | 15.2 | 13.1 | 11.6 | 14.6 | 12.8 | 11.4 | 115 |
| 120 | | | | 15.1 | 13.1 | 11.7 | 15.1 | 13 | 11.6 | 14.9 | 12.9 | 11.5 | 14.4 | 12.6 | 11.3 | 120 |
| 125 | | | | 14.7 | 12.8 | 11.6 | 14.8 | 12.8 | 11.5 | 14.6 | 12.7 | 11.4 | 14.1 | 12.4 | 11.2 | 125 |
| 130 | | | | 14.4 | 12.6 | 11.5 | 14.4 | 12.6 | 11.4 | 14.3 | 12.5 | 11.4 | 13.9 | 12.3 | 11.1 | 130 |
| 135 | | | | 14.1 | 12.4 | 11.4 | 14.1 | 12.4 | 11.4 | 14 | 12.3 | 11.3 | 13.6 | 12.1 | 11.1 | 135 |
| 140 | | | | 13.7 | 12.2 | 11.4 | 13.8 | 12.3 | 11.3 | 13.8 | 12.2 | 11.2 | 13.4 | 11.9 | 11 | 140 |
| 145 | | | | 13.4 | 12.1 | 11.4 | 13.6 | 12.1 | 11.3 | 13.5 | 12 | 11.2 | 13.2 | 11.8 | 11 | 145 |
| 150 | | | | 13.1 | 11.9 | 11.4 | 13.3 | 11.9 | 11.2 | 13.2 | 11.9 | 11.1 | 13 | 11.7 | 10.9 | 150 |
| 155 | | | | 12.9 | 11.8 | 11.4 | 13 | 11.8 | 11.2 | 13 | 11.7 | 11.1 | 12.8 | 11.5 | 10.9 | 155 |
| 160 | | | | 12.6 | 11.7 | 11.4 | 12.8 | 11.7 | 11.2 | 12.8 | 11.6 | 11.1 | 12.6 | 11.4 | 10.8 | 160 |
| 165 | | | | 12.3 | 11.6 | 11.4 | 12.5 | 11.6 | 11.2 | 12.5 | 11.5 | 11.1 | 12.4 | 11.3 | 10.8 | 165 |
| 170 | | | | 12 | 11.5 | 11.4 | 12.3 | 11.5 | 11.2 | 12.3 | 11.4 | 11.1 | 12.2 | 11.2 | 10.8 | 170 |
| 175 | | | | 11.8 | 11.5 | 11.4 | 12.1 | 11.4 | 11.2 | 12.1 | 11.3 | 11.1 | 12 | 11.1 | 10.8 | 175 |
| 180 | | | | 11.5 | 11.4 | 8.6 | 11.8 | 11.3 | 11.2 | 12 | 11.2 | 11.1 | 11.8 | 11.1 | 10.8 | 180 |
| 185 | | | | 11.2 | 11.3 | 6.2 | 11.6 | 11.3 | 11.2 | 11.8 | 11.2 | 11.1 | 11.7 | 11 | 10.8 | 185 |
| 190 | | | | 10.9 | 11.3 | | 11.4 | 11.3 | 10.3 | 11.6 | 11.1 | 11.1 | 11.5 | 10.9 | 10.8 | 190 |
| 195 | | | | 10.6 | 11.3 | | 11.2 | 11.2 | 7.6 | 11.4 | 11.1 | 11.1 | 11.2 | 10.9 | 10.8 | 195 |
| 200 | | | | 10.2 | 10.7 | | 11 | 11.2 | 5.8 | 11.3 | 11.1 | 11.1 | 11 | 10.9 | 10.8 | 200 |
| 205 | | | | | | | 10.8 | 11.2 | | 11.1 | 11 | 9.1 | 10.7 | 10.9 | 10.8 | 205 |
| 210 | | | | | | | 10.5 | 11.2 | | 10.9 | 11 | 7 | 10.1 | 10.6 | 10.8 | 210 |
| 215 | | | | | | | 7.7 | 10.6 | | 10.7 | 10.9 | 5.4 | 9.4 | 10.2 | 10.3 | 215 |
| 220 | | | | | | | | | | 10.1 | 10.7 | | 9 | 9.4 | 8.2 | 220 |
| 225 | | | | | | | | | | 8.8 | 9.9 | | 8.7 | 8.8 | 6.4 | 225 |
| 230 | | | | | | | | | | 6 | 8.1 | | 8.3 | 8.5 | 5.2 | 230 |
| 235 | | | | | | | | | | | 3 | | 8 | 8.2 | | 235 |
| 240 | | | | | | | | | | | | | 7 | 7.9 | | 240 |
| 245 | | | | | | | | | | | | | 5.2 | 6.5 | | 245 |
| 250 | | | | | | | | | | | | | | 5.2 | | 250 |

t_240_002_50301_00_000 / 52301_00_000 / 54301_00_000

Lifting capacities Forces de levage

TK

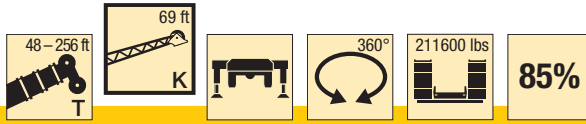

| ft | 208 ft | | | 224 ft | | | 240 ft | | | 253 ft | | | 256 ft | | | ft |
|-----|--------|------|------|--------|------|------|--------|------|------|--------|------|-----|--------|-----|-----|-----|
| | 69 ft | | | 69 ft | | | 69 ft | | | 69 ft | | | 69 ft | | | |
| | 0° | 20° | 40° | 0° | 20° | 40° | 0° | 20° | 40° | 0° | 20° | 40° | 0° | 20° | 40° | |
| 45 | 15.8 | | | | | | | | | | | | | | | 45 |
| 50 | 15.9 | | | 14 | | | | | | | | | | | | 50 |
| 55 | 15.9 | | | 14.1 | | | 12.2 | | | | | | | | | 55 |
| 60 | 15.8 | | | 14.1 | | | 12.2 | | | 10.6 | | | 10.4 | | | 60 |
| 65 | 15.7 | | | 14 | | | 12.2 | | | 10.6 | | | 10.4 | | | 65 |
| 70 | 15.6 | 14.1 | | 14 | | | 12.2 | | | 10.7 | | | 10.4 | | | 70 |
| 75 | 15.5 | 13.9 | | 13.8 | | | 12.1 | | | 10.7 | | | 10.5 | | | 75 |
| 80 | 15.2 | 13.6 | | 13.7 | 12.6 | | 12.1 | | | 10.7 | | | 10.4 | | | 80 |
| 85 | 15 | 13.4 | | 13.6 | 12.5 | | 12 | 11.3 | | 10.6 | | | 10.4 | | | 85 |
| 90 | 14.8 | 13.2 | 11.7 | 13.4 | 12.3 | | 11.9 | 11.2 | | 10.6 | 10.2 | | 10.4 | 10 | | 90 |
| 95 | 14.6 | 13 | 11.5 | 13.2 | 12.1 | 11.1 | 11.8 | 11.1 | | 10.5 | 10.1 | | 10.3 | 9.9 | | 95 |
| 100 | 14.4 | 12.8 | 11.4 | 13.1 | 12 | 11 | 11.7 | 11 | | 10.4 | 10.1 | | 10.3 | 9.9 | | 100 |
| 105 | 14.2 | 12.6 | 11.3 | 13 | 11.9 | 10.9 | 11.6 | 10.9 | 10.3 | 10.4 | 10 | | 10.2 | 9.8 | | 105 |
| 110 | 14 | 12.4 | 11.2 | 12.8 | 11.7 | 10.8 | 11.5 | 10.8 | 10.3 | 10.3 | 9.9 | 9.6 | 10.1 | 9.8 | 9.5 | 110 |
| 115 | 13.8 | 12.3 | 11.1 | 12.7 | 11.6 | 10.7 | 11.4 | 10.7 | 10.2 | 10.2 | 9.8 | 9.5 | 10 | 9.7 | 9.4 | 115 |
| 120 | 13.6 | 12.1 | 11 | 12.5 | 11.5 | 10.6 | 11.2 | 10.6 | 10.1 | 10.1 | 9.6 | 9.4 | 10 | 9.5 | 9.3 | 120 |
| 125 | 13.4 | 12 | 11 | 12.4 | 11.4 | 10.6 | 11.1 | 10.5 | 10.1 | 10 | 9.4 | 9.2 | 9.9 | 9.4 | 9.1 | 125 |
| 130 | 13.2 | 11.8 | 10.9 | 12.2 | 11.2 | 10.5 | 10.9 | 10.4 | 10 | 9.8 | 9.2 | 8.9 | 9.7 | 9.1 | 8.9 | 130 |
| 135 | 13 | 11.7 | 10.8 | 12.1 | 11.1 | 10.5 | 10.8 | 10.2 | 9.9 | 9.5 | 9 | 8.7 | 9.4 | 8.9 | 8.7 | 135 |
| 140 | 12.8 | 11.5 | 10.8 | 11.9 | 11 | 10.5 | 10.6 | 10 | 9.7 | 9.2 | 8.7 | 8.5 | 9.2 | 8.7 | 8.5 | 140 |
| 145 | 12.6 | 11.4 | 10.7 | 11.8 | 10.9 | 10.4 | 10.4 | 9.8 | 9.5 | 9 | 8.5 | 8.3 | 8.9 | 8.5 | 8.3 | 145 |
| 150 | 12.4 | 11.3 | 10.7 | 11.6 | 10.8 | 10.4 | 10.2 | 9.5 | 9.3 | 8.7 | 8.3 | 8.1 | 8.7 | 8.3 | 8.1 | 150 |
| 155 | 12.2 | 11.2 | 10.7 | 11.5 | 10.7 | 10.4 | 10 | 9.3 | 9.1 | 8.5 | 8.1 | 7.9 | 8.4 | 8.1 | 7.9 | 155 |
| 160 | 12.1 | 11.1 | 10.6 | 11.3 | 10.6 | 10.3 | 9.7 | 9.1 | 8.9 | 8.2 | 7.9 | 7.8 | 8.2 | 7.9 | 7.8 | 160 |
| 165 | 11.9 | 11 | 10.6 | 11.1 | 10.5 | 10.3 | 9.5 | 8.9 | 8.8 | 8 | 7.7 | 7.6 | 7.9 | 7.7 | 7.6 | 165 |
| 170 | 11.8 | 10.9 | 10.6 | 10.8 | 10.4 | 10.3 | 9.2 | 8.7 | 8.6 | 7.7 | 7.6 | 7.5 | 7.7 | 7.5 | 7.5 | 170 |
| 175 | 11.6 | 10.9 | 10.6 | 10.5 | 10.2 | 10.3 | 8.9 | 8.5 | 8.4 | 7.4 | 7.4 | 7.3 | 7.4 | 7.4 | 7.3 | 175 |
| 180 | 11.4 | 10.8 | 10.6 | 10.2 | 10 | 10.2 | 8.7 | 8.3 | 8.2 | 7.2 | 7.2 | 7.2 | 7.2 | 7.2 | 7.2 | 180 |
| 185 | 11.1 | 10.7 | 10.6 | 9.9 | 9.8 | 10 | 8.5 | 8.1 | 8.1 | 7 | 7 | 7 | 6.9 | 7 | 7 | 185 |
| 190 | 10.8 | 10.7 | 10.6 | 9.6 | 9.6 | 9.8 | 8.2 | 8 | 7.9 | 6.8 | 6.8 | 6.9 | 6.7 | 6.8 | 6.9 | 190 |
| 195 | 10.6 | 10.6 | 10.6 | 9.3 | 9.3 | 9.6 | 7.9 | 7.8 | 7.8 | 6.6 | 6.7 | 6.8 | 6.5 | 6.6 | 6.7 | 195 |
| 200 | 10.3 | 10.5 | 10.6 | 9.1 | 9.1 | 9.3 | 7.7 | 7.6 | 7.6 | 6.4 | 6.5 | 6.6 | 6.3 | 6.4 | 6.6 | 200 |
| 205 | 9.9 | 10.2 | 10.5 | 8.8 | 8.8 | 9 | 7.5 | 7.5 | 7.5 | 6.2 | 6.3 | 6.4 | 6.2 | 6.2 | 6.4 | 205 |
| 210 | 9.5 | 9.8 | 10.2 | 8.5 | 8.5 | 8.7 | 7.3 | 7.3 | 7.4 | 6 | 6.1 | 6.2 | 6 | 6 | 6.2 | 210 |
| 215 | 9.1 | 9.5 | 9.9 | 8.2 | 8.3 | 8.5 | 7.1 | 7.1 | 7.2 | 5.8 | 5.9 | 6 | 5.8 | 5.9 | 6 | 215 |
| 220 | 8.6 | 9.1 | 9.4 | 7.9 | 8 | 8.2 | 6.9 | 6.9 | 7.1 | 5.6 | 5.7 | 5.9 | 5.6 | 5.7 | 5.8 | 220 |
| 225 | 7.9 | 8.7 | 8.9 | 7.6 | 7.7 | 8 | 6.7 | 6.8 | 6.9 | 5.5 | 5.5 | 5.7 | 5.3 | 5.5 | 5.7 | 225 |
| 230 | 7.3 | 8.1 | 8.4 | 7.3 | 7.5 | 7.7 | 6.5 | 6.6 | 6.8 | 5.3 | 5.4 | 5.5 | 5 | 5.3 | 5.5 | 230 |
| 235 | 7 | 7.5 | 7.5 | 6.9 | 7.2 | 7.4 | 6.3 | 6.4 | 6.6 | 5.1 | 5.2 | 5.4 | 4.7 | 5.2 | 5.3 | 235 |
| 240 | 6.8 | 7 | 6.1 | 6.5 | 6.9 | 7.1 | 6.1 | 6.3 | 6.4 | 5 | 5 | 5.2 | 4.5 | 5 | 5.1 | 240 |
| 245 | 6.6 | 6.7 | 5 | 6.1 | 6.6 | 6.8 | 5.9 | 6.1 | 6.2 | 4.8 | 4.9 | 5 | 4.2 | 4.7 | 4.8 | 245 |
| 250 | 6.4 | 6.5 | | 5.7 | 6.2 | 6.3 | 5.7 | 5.9 | 6.1 | 4.6 | 4.7 | 4.9 | 3.9 | 4.4 | 4.5 | 250 |
| 255 | 5.7 | 6.2 | | 5.5 | 5.7 | 5.7 | 5.4 | 5.7 | 5.9 | 4.4 | 4.6 | 4.7 | 3.6 | 4.1 | 4.2 | 255 |
| 260 | 4.9 | 5.4 | | 5.4 | 5.4 | | 4.9 | 5.4 | 5.6 | 4.2 | 4.4 | 4.5 | 3.3 | 3.7 | 3.9 | 260 |
| 265 | | 3.4 | | 5.2 | 5.3 | | 4.4 | 5.1 | 5.3 | 4 | 4.2 | 4.4 | 3 | 3.4 | 3.5 | 265 |
| 270 | | | | 4.7 | 5.1 | | 3.9 | 4.5 | 4.6 | 3.7 | 4 | 4.1 | 2.7 | 3.1 | 3.2 | 270 |
| 275 | | | | 2.8 | 4.5 | | 3.3 | 3.9 | | 3.3 | 3.8 | 3.9 | 2.4 | 2.8 | 2.9 | 275 |
| 280 | | | | | | | 2.8 | 3.4 | | 2.5 | 3.4 | 3.5 | | 2.5 | 2.5 | 280 |
| 285 | | | | | | | | 2.8 | | | 2.9 | 2.9 | | | | 285 |

t_240_002_50301_00_000 / 52301_00_000 / 54301_00_000

Lifting heights Hauteurs de levage

TK

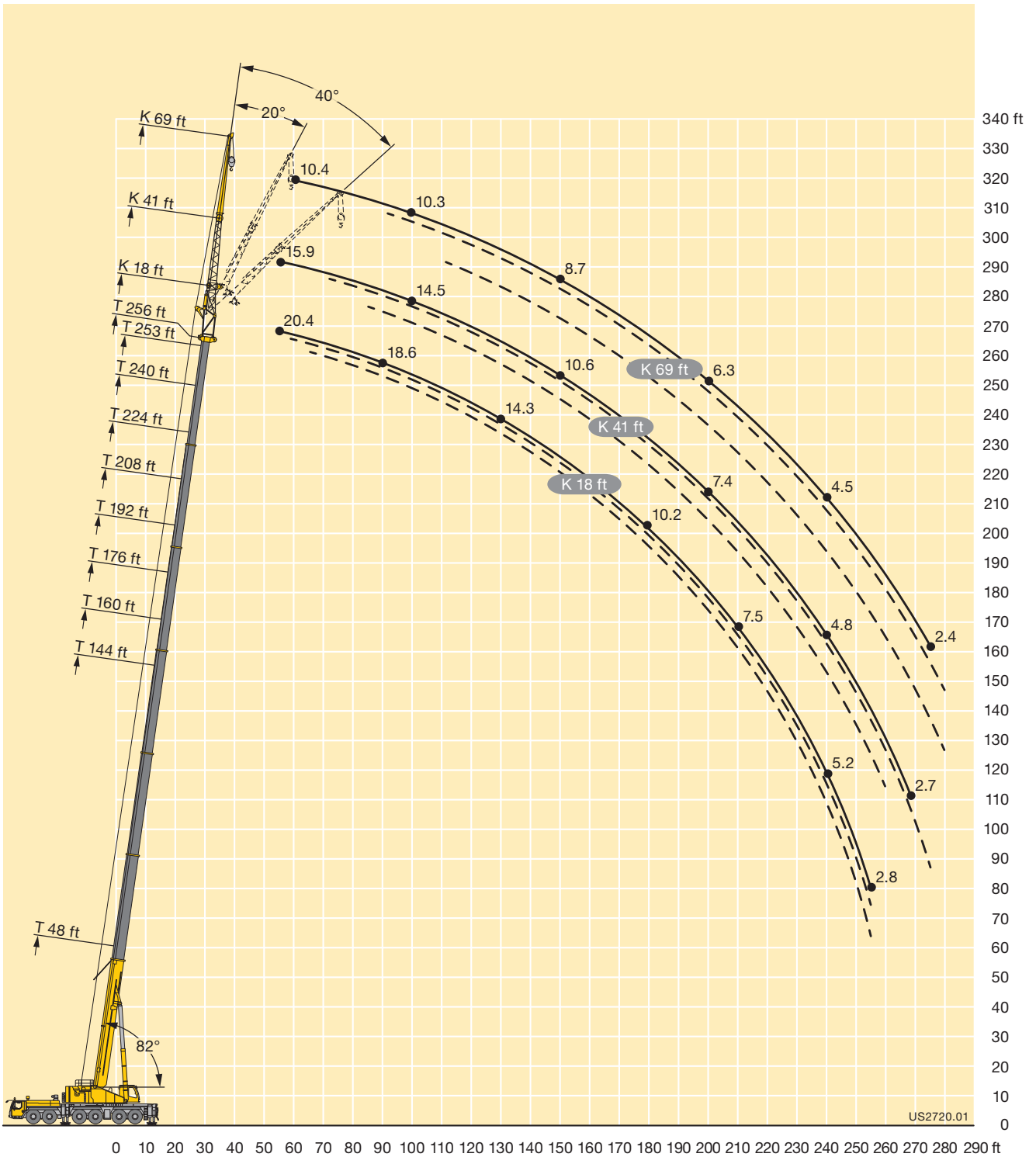

Lifting capacities Forces de levage

TK



| ft | 48 ft | | | 144 ft | | | 160 ft | | | 176 ft | | | 192 ft | | | ft |
|-----|-------|------|------|--------|------|------|--------|------|------|--------|------|------|--------|------|------|-----|
| | 64 ft | | | 64 ft | | | 64 ft | | | 64 ft | | | 64 ft | | | |
| | 0° | 20° | 40° | 0° | 20° | 40° | 0° | 20° | 40° | 0° | 20° | 40° | 0° | 20° | 40° | |
| 12 | 31.4 | | | | | | | | | | | | | | | 12 |
| 13 | 31.4 | | | | | | | | | | | | | | | 13 |
| 14 | 31.4 | | | | | | | | | | | | | | | 14 |
| 15 | 31.4 | | | | | | | | | | | | | | | 15 |
| 16 | 31.2 | | | | | | | | | | | | | | | 16 |
| 17 | 31 | | | | | | | | | | | | | | | 17 |
| 18 | 30.7 | | | | | | | | | | | | | | | 18 |
| 19 | 30.5 | | | | | | | | | | | | | | | 19 |
| 20 | 30.2 | | | | | | | | | | | | | | | 20 |
| 22 | 29.6 | | | | | | | | | | | | | | | 22 |
| 24 | 29 | | | | | | | | | | | | | | | 24 |
| 26 | 28.4 | | | | | | | | | | | | | | | 26 |
| 28 | 27.7 | | | 31.4 | | | | | | | | | | | | 28 |
| 30 | 27.1 | | | 31.4 | | | 27 | | | | | | | | | 30 |
| 32 | 26.4 | 22.9 | | 31.4 | | | 27 | | | | | | | | | 32 |
| 34 | 25.8 | 22.3 | | 31.3 | | | 27 | | | 24.9 | | | | | | 34 |
| 36 | 25.2 | 21.6 | | 31.1 | | | 27 | | | 24.9 | | | | | | 36 |
| 38 | 24.6 | 21 | | 30.9 | | | 27 | | | 24.9 | | | 22.1 | | | 38 |
| 40 | 24 | 20.4 | | 30.6 | | | 27 | | | 25 | | | 22.1 | | | 40 |
| 45 | 22.6 | 19.1 | | 29.8 | | | 27 | | | 25 | | | 22.1 | | | 45 |
| 50 | 21.2 | 17.9 | 15.1 | 29 | 22.7 | | 26.9 | | | 25 | | | 22.2 | | | 50 |
| 55 | 19.7 | 16.9 | 14.3 | 28.1 | 21.8 | | 26.7 | 22.3 | | 24.7 | | | 22.1 | | | 55 |
| 60 | 18.2 | 16 | 13.7 | 27.3 | 21 | | 26.1 | 21.7 | | 24.3 | 20.9 | | 21.9 | | | 60 |
| 65 | 16.9 | 15.2 | 13.1 | 26.4 | 20.3 | 15.4 | 25.5 | 21.2 | | 23.9 | 20.4 | | 21.6 | 19.3 | | 65 |
| 70 | 15.6 | 14.5 | 12.6 | 25.6 | 19.6 | 15 | 25 | 20.6 | 15.9 | 23.4 | 19.9 | | 21.3 | 18.9 | | 70 |
| 75 | 14.5 | 13.8 | 12.2 | 24.8 | 18.9 | 14.6 | 24.3 | 20.1 | 15.7 | 23 | 19.5 | 15.5 | 21 | 18.6 | | 75 |
| 80 | 13.6 | 13.2 | 11.9 | 24 | 18.3 | 14.3 | 23.7 | 19.6 | 15.4 | 22.5 | 19.1 | 15.2 | 20.7 | 18.2 | 14.9 | 80 |
| 85 | 12.7 | 12.7 | 11.7 | 23.2 | 17.8 | 14 | 23.1 | 19.1 | 15.1 | 22.1 | 18.7 | 14.9 | 20.4 | 17.9 | 14.6 | 85 |
| 90 | 11.9 | 12.2 | 11.6 | 22.4 | 17.2 | 13.7 | 22.5 | 18.6 | 14.8 | 21.6 | 18.2 | 14.7 | 20 | 17.5 | 14.4 | 90 |
| 95 | 11.3 | 11.8 | 11.6 | 21.7 | 16.7 | 13.4 | 21.9 | 18.1 | 14.5 | 21.1 | 17.8 | 14.4 | 19.7 | 17.2 | 14.2 | 95 |
| 100 | 10.7 | 11.6 | 5.1 | 20.9 | 16.2 | 13.1 | 21.4 | 17.6 | 14.3 | 20.7 | 17.4 | 14.2 | 19.4 | 16.8 | 14 | 100 |
| 105 | 10.3 | | | 20.1 | 15.8 | 12.9 | 20.8 | 17.1 | 14.1 | 20.2 | 17 | 14 | 19.1 | 16.5 | 13.8 | 105 |
| 110 | | | | 19.3 | 15.4 | 12.7 | 20.3 | 16.7 | 13.9 | 19.8 | 16.6 | 13.8 | 18.8 | 16.2 | 13.6 | 110 |
| 115 | | | | 18.5 | 15 | 12.5 | 19.8 | 16.3 | 13.7 | 19.4 | 16.2 | 13.6 | 18.4 | 15.9 | 13.4 | 115 |
| 120 | | | | 17.7 | 14.7 | 12.3 | 19.3 | 15.9 | 13.5 | 18.9 | 15.9 | 13.4 | 18.1 | 15.5 | 13.2 | 120 |
| 125 | | | | 17 | 14.3 | 12.1 | 18.8 | 15.6 | 13.3 | 18.5 | 15.6 | 13.3 | 17.8 | 15.2 | 13.1 | 125 |
| 130 | | | | 16.3 | 14 | 12 | 18.3 | 15.3 | 13.2 | 18.1 | 15.2 | 13.1 | 17.5 | 15 | 13 | 130 |
| 135 | | | | 15.6 | 13.7 | 11.9 | 17.8 | 14.9 | 13 | 17.7 | 15 | 13 | 17.2 | 14.7 | 12.8 | 135 |
| 140 | | | | 15 | 13.4 | 11.8 | 17.3 | 14.6 | 12.9 | 17.3 | 14.7 | 12.9 | 16.8 | 14.4 | 12.8 | 140 |
| 145 | | | | 14.5 | 13.1 | 11.7 | 16.9 | 14.3 | 12.8 | 16.9 | 14.4 | 12.8 | 16.5 | 14.2 | 12.7 | 145 |
| 150 | | | | 14 | 12.9 | 11.7 | 16.4 | 14 | 12.8 | 16.5 | 14.1 | 12.7 | 16.2 | 14 | 12.6 | 150 |
| 155 | | | | 13.5 | 12.6 | 11.6 | 15.9 | 13.8 | 12.7 | 16.1 | 13.9 | 12.7 | 15.8 | 13.7 | 12.5 | 155 |
| 160 | | | | 13 | 12.3 | 11.6 | 15.4 | 13.5 | 12.6 | 15.7 | 13.6 | 12.6 | 15.5 | 13.5 | 12.5 | 160 |
| 165 | | | | 12.5 | 12.1 | 11.6 | 14.9 | 13.3 | 12.6 | 15.3 | 13.3 | 12.6 | 15.1 | 13.3 | 12.4 | 165 |
| 170 | | | | 12.1 | 12 | 11.6 | 14.4 | 13 | 12.6 | 14.9 | 13.1 | 12.5 | 14.7 | 13.1 | 12.4 | 170 |
| 175 | | | | 11.8 | 11.8 | 8.6 | 13.9 | 12.8 | 12.6 | 14.5 | 12.9 | 12.5 | 14.2 | 12.9 | 12.3 | 175 |
| 180 | | | | 11.4 | 11.7 | 6.3 | 13.5 | 12.6 | 12.6 | 14.1 | 12.7 | 12.5 | 13.8 | 12.7 | 12.3 | 180 |
| 185 | | | | 11.1 | 11.6 | | 13.1 | 12.5 | 10.6 | 13.7 | 12.5 | 12.4 | 13.3 | 12.5 | 12.3 | 185 |
| 190 | | | | 10.8 | 11.6 | | 12.7 | 12.3 | 7.6 | 13.3 | 12.4 | 12.4 | 12.7 | 12.2 | 12.3 | 190 |
| 195 | | | | 10.5 | 11.1 | | 12.3 | 12.3 | 5.8 | 12.8 | 12.3 | 11.8 | 12.2 | 12 | 12.3 | 195 |
| 200 | | | | | | | 12 | 12.2 | | 12.4 | 12.2 | 9.1 | 11.3 | 11.8 | 12 | 200 |
| 205 | | | | | | | 11.5 | 12.2 | | 11.9 | 11.9 | 7 | 10.5 | 11.4 | 11.6 | 205 |
| 210 | | | | | | | 8.2 | 10.9 | | 11.2 | 11.5 | 5.5 | 9.7 | 10.6 | 10.6 | 210 |
| 215 | | | | | | | | 3.8 | | 10.5 | 11 | | 9.4 | 9.7 | 8.2 | 215 |
| 220 | | | | | | | | | | 9.3 | 10.2 | | 9 | 9.2 | 6.5 | 220 |
| 225 | | | | | | | | | | 6.3 | 8.4 | | 8.7 | 8.8 | 5.2 | 225 |
| 230 | | | | | | | | | | | 3.4 | | 8.3 | 8.5 | | 230 |
| 235 | | | | | | | | | | | | | 7.4 | 8.1 | | 235 |
| 240 | | | | | | | | | | | | | 5.4 | 6.8 | | 240 |
| 245 | | | | | | | | | | | | | 4.1 | 5.4 | | 245 |

t_240_002_50201_00_000 / 52201_00_000 / 54201_00_000

Lifting capacities Forces de levage

TK



| ft | 208 ft | | | 224 ft | | | 240 ft | | | 253 ft | | | 256 ft | | | ft |
|-----|--------|------|------|--------|------|------|--------|------|------|--------|------|------|--------|------|------|-----|
| | 64 ft | | | 64 ft | | | 64 ft | | | 64 ft | | | 64 ft | | | |
| | 0° | 20° | 40° | 0° | 20° | 40° | 0° | 20° | 40° | 0° | 20° | 40° | 0° | 20° | 40° | |
| 45 | 19.2 | | | | | | | | | | | | | | | 45 |
| 50 | 19.2 | | | 16.4 | | | | | | | | | | | | 50 |
| 55 | 19.3 | | | 16.4 | | | 13.8 | | | | | | | | | 55 |
| 60 | 19.2 | | | 16.4 | | | 13.9 | | | 11.9 | | | 11.6 | | | 60 |
| 65 | 19.1 | | | 16.4 | | | 13.9 | | | 11.9 | | | 11.6 | | | 65 |
| 70 | 18.9 | 17.5 | | 16.4 | | | 13.9 | | | 12 | | | 11.7 | | | 70 |
| 75 | 18.7 | 17.2 | | 16.3 | 15.5 | | 13.9 | | | 12 | | | 11.7 | | | 75 |
| 80 | 18.5 | 17 | | 16.2 | 15.4 | | 13.8 | | | 11.8 | | | 11.6 | | | 80 |
| 85 | 18.3 | 16.7 | 14.2 | 16 | 15.2 | | 13.7 | 13.2 | | 11.7 | | | 11.5 | | | 85 |
| 90 | 18.1 | 16.5 | 14 | 15.9 | 15.1 | | 13.6 | 13.2 | | 11.6 | 11.2 | | 11.4 | 10.9 | | 90 |
| 95 | 17.9 | 16.2 | 13.8 | 15.7 | 14.9 | 13.1 | 13.5 | 13.1 | | 11.5 | 11.2 | | 11.3 | 10.9 | | 95 |
| 100 | 17.7 | 15.9 | 13.6 | 15.6 | 14.8 | 13 | 13.3 | 12.9 | 12.1 | 11.4 | 11.1 | | 11.2 | 10.8 | | 100 |
| 105 | 17.4 | 15.7 | 13.4 | 15.4 | 14.6 | 12.9 | 13.2 | 12.6 | 12 | 11.2 | 10.9 | 10.5 | 11.1 | 10.7 | 10.4 | 105 |
| 110 | 17.2 | 15.4 | 13.2 | 15.2 | 14.4 | 12.7 | 13 | 12.2 | 11.7 | 11.1 | 10.6 | 10.2 | 10.9 | 10.5 | 10.2 | 110 |
| 115 | 17 | 15.2 | 13.1 | 15 | 14.2 | 12.6 | 12.8 | 11.9 | 11.4 | 10.9 | 10.3 | 10 | 10.7 | 10.2 | 9.9 | 115 |
| 120 | 16.8 | 14.9 | 13 | 14.8 | 14 | 12.5 | 12.5 | 11.6 | 11.2 | 10.7 | 10.1 | 9.7 | 10.6 | 10 | 9.7 | 120 |
| 125 | 16.6 | 14.7 | 12.8 | 14.6 | 13.8 | 12.4 | 12.2 | 11.3 | 10.9 | 10.5 | 9.8 | 9.5 | 10.4 | 9.7 | 9.4 | 125 |
| 130 | 16.3 | 14.4 | 12.7 | 14.3 | 13.6 | 12.3 | 11.8 | 11 | 10.6 | 10.2 | 9.6 | 9.3 | 10.1 | 9.5 | 9.2 | 130 |
| 135 | 16.1 | 14.2 | 12.6 | 14 | 13.4 | 12.2 | 11.5 | 10.7 | 10.4 | 9.9 | 9.3 | 9 | 9.8 | 9.2 | 9 | 135 |
| 140 | 15.9 | 14 | 12.5 | 13.7 | 13.2 | 12.2 | 11.2 | 10.5 | 10.1 | 9.6 | 9.1 | 8.8 | 9.5 | 9 | 8.8 | 140 |
| 145 | 15.6 | 13.8 | 12.4 | 13.2 | 12.9 | 12.1 | 10.9 | 10.2 | 9.9 | 9.3 | 8.9 | 8.6 | 9.2 | 8.8 | 8.6 | 145 |
| 150 | 15.2 | 13.6 | 12.4 | 12.8 | 12.6 | 12 | 10.6 | 9.9 | 9.7 | 9 | 8.6 | 8.4 | 8.9 | 8.6 | 8.4 | 150 |
| 155 | 14.8 | 13.4 | 12.3 | 12.4 | 12.2 | 11.9 | 10.4 | 9.7 | 9.5 | 8.7 | 8.4 | 8.2 | 8.6 | 8.4 | 8.2 | 155 |
| 160 | 14.3 | 13.1 | 12.2 | 12 | 11.8 | 11.7 | 10.1 | 9.5 | 9.2 | 8.4 | 8.2 | 8 | 8.3 | 8.2 | 8 | 160 |
| 165 | 13.9 | 12.9 | 12.2 | 11.6 | 11.5 | 11.5 | 9.8 | 9.2 | 9 | 8.1 | 8 | 7.8 | 8.1 | 7.9 | 7.8 | 165 |
| 170 | 13.4 | 12.7 | 12.1 | 11.2 | 11.1 | 11.2 | 9.5 | 9 | 8.9 | 7.8 | 7.8 | 7.7 | 7.8 | 7.7 | 7.7 | 170 |
| 175 | 13 | 12.5 | 12.1 | 10.9 | 10.8 | 10.9 | 9.2 | 8.8 | 8.7 | 7.5 | 7.5 | 7.5 | 7.5 | 7.5 | 7.5 | 175 |
| 180 | 12.5 | 12.2 | 12 | 10.5 | 10.5 | 10.6 | 9 | 8.6 | 8.5 | 7.2 | 7.3 | 7.3 | 7.2 | 7.3 | 7.3 | 180 |
| 185 | 12 | 11.9 | 11.9 | 10.1 | 10.1 | 10.3 | 8.7 | 8.4 | 8.3 | 7 | 7.1 | 7.2 | 7 | 7.1 | 7.1 | 185 |
| 190 | 11.4 | 11.6 | 11.7 | 9.8 | 9.8 | 10 | 8.4 | 8.2 | 8.2 | 6.8 | 6.9 | 7 | 6.8 | 6.9 | 7 | 190 |
| 195 | 10.9 | 11.3 | 11.6 | 9.5 | 9.5 | 9.7 | 8.1 | 8 | 8 | 6.6 | 6.7 | 6.8 | 6.6 | 6.7 | 6.8 | 195 |
| 200 | 10.4 | 10.9 | 11.1 | 9.2 | 9.2 | 9.4 | 7.8 | 7.9 | 7.9 | 6.4 | 6.5 | 6.6 | 6.4 | 6.5 | 6.6 | 200 |
| 205 | 10 | 10.4 | 10.7 | 8.9 | 8.9 | 9.1 | 7.6 | 7.6 | 7.7 | 6.2 | 6.3 | 6.4 | 6.2 | 6.3 | 6.4 | 205 |
| 210 | 9.5 | 9.9 | 10.2 | 8.6 | 8.6 | 8.8 | 7.4 | 7.4 | 7.5 | 6 | 6.1 | 6.2 | 6 | 6.1 | 6.2 | 210 |
| 215 | 8.9 | 9.5 | 9.7 | 8.3 | 8.3 | 8.6 | 7.2 | 7.2 | 7.3 | 5.8 | 5.9 | 6 | 5.8 | 5.9 | 6 | 215 |
| 220 | 8.3 | 9 | 9.2 | 7.9 | 8 | 8.3 | 7 | 7 | 7.1 | 5.7 | 5.7 | 5.9 | 5.5 | 5.7 | 5.9 | 220 |
| 225 | 7.6 | 8.4 | 8.6 | 7.6 | 7.7 | 8 | 6.7 | 6.8 | 6.9 | 5.5 | 5.5 | 5.7 | 5.2 | 5.5 | 5.7 | 225 |
| 230 | 7.3 | 7.7 | 7.5 | 7.2 | 7.4 | 7.7 | 6.5 | 6.6 | 6.8 | 5.3 | 5.4 | 5.5 | 4.9 | 5.3 | 5.5 | 230 |
| 235 | 7 | 7.1 | 6.1 | 6.8 | 7.1 | 7.3 | 6.3 | 6.4 | 6.6 | 5.2 | 5.2 | 5.3 | 4.6 | 5.1 | 5.3 | 235 |
| 240 | 6.8 | 6.9 | 5 | 6.3 | 6.8 | 7 | 6.1 | 6.3 | 6.4 | 5 | 5 | 5.2 | 4.3 | 4.8 | 5 | 240 |
| 245 | 6.6 | 6.6 | | 5.9 | 6.3 | 6.5 | 5.8 | 6.1 | 6.2 | 4.8 | 4.9 | 5 | 4.1 | 4.5 | 4.7 | 245 |
| 250 | 6 | 6.4 | | 5.7 | 5.8 | 5.8 | 5.6 | 5.9 | 6.1 | 4.6 | 4.7 | 4.9 | 3.8 | 4.2 | 4.4 | 250 |
| 255 | 5 | 5.6 | | 5.5 | 5.6 | | 5.1 | 5.6 | 5.8 | 4.4 | 4.6 | 4.7 | 3.5 | 3.8 | 4 | 255 |
| 260 | | 3.6 | | 5.4 | 5.4 | | 4.6 | 5.3 | 5.4 | 4.1 | 4.4 | 4.5 | 3.2 | 3.5 | 3.7 | 260 |
| 265 | | | | 4.9 | 5.3 | | 4 | 4.7 | 4.8 | 3.8 | 4.1 | 4.3 | 2.9 | 3.2 | 3.3 | 265 |
| 270 | | | | 3 | 4.6 | | 3.5 | 4.1 | | 3.3 | 3.9 | 4 | 2.6 | 2.9 | 3 | 270 |
| 275 | | | | | | | 3 | 3.5 | | | 3.5 | 3.6 | | 2.6 | 2.6 | 275 |
| 280 | | | | | | | | 2.9 | | | 2.5 | 2.6 | | | | 280 |

t_240_002_50201_00_000 / 52201_00_000 / 54201_00_000

Lifting capacities Forces de levage

TK

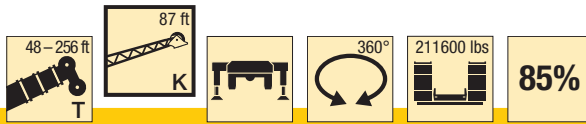

| ft | 48 ft | | | 144 ft | | | 160 ft | | | 176 ft | | | 192 ft | | | ft |
|-----|-------|------|-----|--------|------|-----|--------|------|-----|--------|------|-----|--------|------|-----|-----|
| | 87 ft | | | 87 ft | | | 87 ft | | | 87 ft | | | 87 ft | | | |
| | 0° | 20° | 40° | 0° | 20° | 40° | 0° | 20° | 40° | 0° | 20° | 40° | 0° | 20° | 40° | |
| 14 | 19.4 | | | | | | | | | | | | | | | 14 |
| 15 | 19.4 | | | | | | | | | | | | | | | 15 |
| 16 | 19.4 | | | | | | | | | | | | | | | 16 |
| 17 | 19.4 | | | | | | | | | | | | | | | 17 |
| 18 | 19.4 | | | | | | | | | | | | | | | 18 |
| 19 | 19.5 | | | | | | | | | | | | | | | 19 |
| 20 | 19.4 | | | | | | | | | | | | | | | 20 |
| 22 | 19.3 | | | | | | | | | | | | | | | 22 |
| 24 | 19.1 | | | | | | | | | | | | | | | 24 |
| 26 | 18.9 | | | | | | | | | | | | | | | 26 |
| 28 | 18.5 | | | | | | | | | | | | | | | 28 |
| 30 | 18.2 | | | | | | | | | | | | | | | 30 |
| 32 | 17.8 | | | 19.4 | | | | | | | | | | | | 32 |
| 34 | 17.5 | | | 19.4 | | | 18 | | | | | | | | | 34 |
| 36 | 17.1 | | | 19.5 | | | 18.1 | | | | | | | | | 36 |
| 38 | 16.8 | | | 19.5 | | | 18.1 | | | 16.5 | | | | | | 38 |
| 40 | 16.4 | | | 19.4 | | | 18.1 | | | 16.6 | | | | | | 40 |
| 45 | 15.6 | 13.5 | | 19.2 | | | 18.1 | | | 16.6 | | | 14.9 | | | 45 |
| 50 | 14.8 | 12.7 | | 18.8 | | | 17.8 | | | 16.5 | | | 15 | | | 50 |
| 55 | 14 | 11.9 | | 18.3 | | | 17.5 | | | 16.4 | | | 14.9 | | | 55 |
| 60 | 13.1 | 11.2 | | 17.8 | | | 17 | | | 16.1 | | | 14.7 | | | 60 |
| 65 | 12.4 | 10.6 | 8.9 | 17.2 | 13.4 | | 16.6 | 13.1 | | 15.7 | | | 14.5 | | | 65 |
| 70 | 11.6 | 10 | 8.5 | 16.7 | 12.9 | | 16.2 | 12.7 | | 15.4 | 12.4 | | 14.3 | | | 70 |
| 75 | 10.9 | 9.5 | 8.1 | 16.2 | 12.4 | | 15.8 | 12.3 | | 15 | 12 | | 14 | 11.6 | | 75 |
| 80 | 10.3 | 9 | 7.8 | 15.7 | 12 | | 15.3 | 11.9 | | 14.7 | 11.7 | | 13.7 | 11.3 | | 80 |
| 85 | 9.7 | 8.5 | 7.5 | 15.2 | 11.5 | 8.7 | 14.9 | 11.5 | | 14.3 | 11.3 | | 13.4 | 11 | | 85 |
| 90 | 9.1 | 8.2 | 7.3 | 14.8 | 11.1 | 8.5 | 14.5 | 11.1 | 8.5 | 14 | 11 | 8.4 | 13.2 | 10.7 | | 90 |
| 95 | 8.6 | 7.8 | 7.1 | 14.3 | 10.8 | 8.3 | 14.1 | 10.8 | 8.3 | 13.6 | 10.7 | 8.2 | 12.9 | 10.4 | 8 | 95 |
| 100 | 8.2 | 7.5 | 6.9 | 13.8 | 10.5 | 8.1 | 13.7 | 10.5 | 8.1 | 13.3 | 10.4 | 8 | 12.6 | 10.1 | 7.9 | 100 |
| 105 | 7.8 | 7.3 | 6.8 | 13.3 | 10.1 | 8 | 13.3 | 10.2 | 7.9 | 13 | 10.1 | 7.9 | 12.3 | 9.8 | 7.8 | 105 |
| 110 | 7.3 | 7 | 6.8 | 12.9 | 9.8 | 7.8 | 12.9 | 9.9 | 7.8 | 12.6 | 9.8 | 7.7 | 12.1 | 9.6 | 7.6 | 110 |
| 115 | 7 | 6.9 | 6.8 | 12.4 | 9.5 | 7.6 | 12.5 | 9.6 | 7.6 | 12.3 | 9.6 | 7.6 | 11.8 | 9.3 | 7.5 | 115 |
| 120 | 6.7 | 6.8 | 6.8 | 12 | 9.3 | 7.5 | 12.1 | 9.3 | 7.5 | 12 | 9.3 | 7.5 | 11.5 | 9.1 | 7.4 | 120 |
| 125 | 6.5 | 6.8 | | 11.5 | 9 | 7.4 | 11.7 | 9.1 | 7.4 | 11.6 | 9 | 7.3 | 11.3 | 8.9 | 7.3 | 125 |
| 130 | | | | 11.1 | 8.8 | 7.3 | 11.4 | 8.8 | 7.3 | 11.3 | 8.8 | 7.2 | 11 | 8.7 | 7.2 | 130 |
| 135 | | | | 10.7 | 8.5 | 7.2 | 11 | 8.6 | 7.2 | 11 | 8.6 | 7.1 | 10.7 | 8.5 | 7.1 | 135 |
| 140 | | | | 10.3 | 8.3 | 7.1 | 10.6 | 8.4 | 7.1 | 10.7 | 8.4 | 7 | 10.4 | 8.3 | 7 | 140 |
| 145 | | | | 10 | 8.1 | 7 | 10.2 | 8.2 | 7 | 10.4 | 8.2 | 7 | 10.2 | 8.2 | 6.9 | 145 |
| 150 | | | | 9.6 | 7.9 | 6.9 | 9.9 | 8 | 6.9 | 10.1 | 8.1 | 6.9 | 9.9 | 8 | 6.8 | 150 |
| 155 | | | | 9.3 | 7.8 | 6.9 | 9.6 | 7.9 | 6.9 | 9.8 | 7.9 | 6.8 | 9.7 | 7.8 | 6.8 | 155 |
| 160 | | | | 9 | 7.6 | 6.8 | 9.3 | 7.7 | 6.8 | 9.5 | 7.7 | 6.8 | 9.4 | 7.7 | 6.7 | 160 |
| 165 | | | | 8.8 | 7.4 | 6.8 | 9 | 7.6 | 6.8 | 9.2 | 7.6 | 6.7 | 9.2 | 7.5 | 6.7 | 165 |
| 170 | | | | 8.5 | 7.3 | 6.8 | 8.8 | 7.4 | 6.8 | 9 | 7.4 | 6.7 | 8.9 | 7.4 | 6.6 | 170 |
| 175 | | | | 8.2 | 7.2 | 6.8 | 8.5 | 7.3 | 6.7 | 8.7 | 7.3 | 6.7 | 8.7 | 7.3 | 6.6 | 175 |
| 180 | | | | 7.9 | 7.1 | 6.8 | 8.3 | 7.2 | 6.7 | 8.5 | 7.2 | 6.6 | 8.5 | 7.2 | 6.6 | 180 |
| 185 | | | | 7.7 | 7 | 6.8 | 8.1 | 7.1 | 6.7 | 8.2 | 7.1 | 6.6 | 8.3 | 7.1 | 6.6 | 185 |
| 190 | | | | 7.5 | 6.9 | 6.8 | 7.9 | 7 | 6.7 | 8 | 7 | 6.6 | 8.1 | 7 | 6.5 | 190 |
| 195 | | | | 7.2 | 6.9 | 6.8 | 7.6 | 6.9 | 6.7 | 7.9 | 6.9 | 6.6 | 7.9 | 6.9 | 6.5 | 195 |
| 200 | | | | 7 | 6.8 | 6.8 | 7.4 | 6.8 | 6.7 | 7.7 | 6.9 | 6.6 | 7.7 | 6.8 | 6.5 | 200 |
| 205 | | | | 6.9 | 6.8 | 5.4 | 7.3 | 6.8 | 6.7 | 7.5 | 6.8 | 6.6 | 7.6 | 6.8 | 6.5 | 205 |
| 210 | | | | 6.7 | 6.8 | | 7.1 | 6.8 | 6.7 | 7.4 | 6.7 | 6.6 | 7.5 | 6.7 | 6.5 | 210 |
| 215 | | | | 6.6 | 6.8 | | 6.9 | 6.8 | 6.5 | 7.2 | 6.7 | 6.6 | 7.3 | 6.7 | 6.5 | 215 |
| 220 | | | | 6.1 | 6.8 | | 6.8 | 6.8 | 5.1 | 7.1 | 6.7 | 6.6 | 7.2 | 6.6 | 6.5 | 220 |
| 225 | | | | | | | 6.6 | 6.8 | | 6.9 | 6.7 | 6.6 | 7.1 | 6.6 | 6.5 | 225 |
| 230 | | | | | | | 6.5 | 6.8 | | 6.8 | 6.6 | 6.2 | 6.9 | 6.6 | 6.5 | 230 |
| 235 | | | | | | | 4.4 | 6.6 | | 6.6 | 6.6 | | 6.8 | 6.6 | 6.5 | 235 |
| 240 | | | | | | | | | | 6.6 | 6.6 | | 6.7 | 6.6 | 6.5 | 240 |
| 245 | | | | | | | | | | 5.7 | 6.6 | | 6.6 | 6.6 | 5.9 | 245 |
| 250 | | | | | | | | | | 2.8 | 5.1 | | 6.5 | 6.5 | | 250 |
| 255 | | | | | | | | | | | | | 6.2 | 6.4 | | 255 |
| 260 | | | | | | | | | | | | | 4.4 | 6.2 | | 260 |
| 265 | | | | | | | | | | | | | 3.9 | 4 | | 265 |

t_240_002_50401_00_000 / 52401_00_000 / 54401_00_000

Lifting capacities Forces de levage

TK

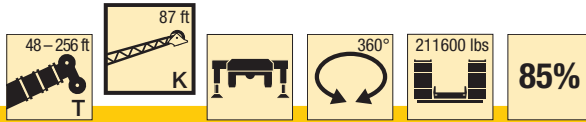

| ft | 208 ft | | | 224 ft | | | 240 ft | | | 253 ft | | | 256 ft | | | ft |
|-----|--------|------|-----|--------|-----|-----|--------|-----|-----|--------|-----|-----|--------|-----|-----|-----|
| | 87 ft | | | 87 ft | | | 87 ft | | | 87 ft | | | 87 ft | | | |
| | 0° | 20° | 40° | 0° | 20° | 40° | 0° | 20° | 40° | 0° | 20° | 40° | 0° | 20° | 40° | |
| 50 | 13.1 | | | | | | | | | | | | | | | 50 |
| 55 | 13.1 | | | 11.2 | | | | | | | | | | | | 55 |
| 60 | 13.1 | | | 11.3 | | | 9.4 | | | | | | | | | 60 |
| 65 | 13 | | | 11.3 | | | 9.5 | | | 7.8 | | | 7.5 | | | 65 |
| 70 | 12.9 | | | 11.2 | | | 9.5 | | | 8.1 | | | 7.8 | | | 70 |
| 75 | 12.7 | | | 11.1 | | | 9.5 | | | 8.2 | | | 7.9 | | | 75 |
| 80 | 12.5 | 10.6 | | 11 | | | 9.5 | | | 8.2 | | | 7.9 | | | 80 |
| 85 | 12.3 | 10.4 | | 10.9 | | | 9.4 | | | 8.1 | | | 7.9 | | | 85 |
| 90 | 12.1 | 10.1 | | 10.8 | 9.4 | | 9.3 | | | 8 | | | 7.8 | | | 90 |
| 95 | 11.9 | 9.9 | | 10.6 | 9.2 | | 9.2 | 8.4 | | 7.9 | | | 7.7 | | | 95 |
| 100 | 11.7 | 9.7 | | 10.5 | 9 | | 9.1 | 8.3 | | 7.8 | 7.4 | | 7.7 | | | 100 |
| 105 | 11.4 | 9.4 | 7.6 | 10.3 | 8.8 | | 9 | 8.1 | | 7.8 | 7.3 | | 7.6 | 7.3 | | 105 |
| 110 | 11.2 | 9.2 | 7.4 | 10.2 | 8.7 | 7.1 | 8.9 | 8 | | 7.7 | 7.3 | | 7.6 | 7.3 | | 110 |
| 115 | 11 | 9 | 7.3 | 10 | 8.5 | 7.1 | 8.8 | 7.9 | 6.7 | 7.7 | 7.3 | | 7.5 | 7.2 | | 115 |
| 120 | 10.8 | 8.8 | 7.2 | 9.9 | 8.4 | 7 | 8.7 | 7.7 | 6.7 | 7.6 | 7.2 | | 7.5 | 7.1 | | 120 |
| 125 | 10.6 | 8.6 | 7.1 | 9.7 | 8.2 | 6.9 | 8.6 | 7.6 | 6.7 | 7.6 | 7.1 | 6.4 | 7.5 | 7 | 6.4 | 125 |
| 130 | 10.4 | 8.5 | 7 | 9.6 | 8 | 6.8 | 8.5 | 7.5 | 6.6 | 7.6 | 7 | 6.4 | 7.4 | 6.9 | 6.3 | 130 |
| 135 | 10.2 | 8.3 | 7 | 9.4 | 7.9 | 6.8 | 8.4 | 7.4 | 6.5 | 7.5 | 6.9 | 6.3 | 7.4 | 6.9 | 6.3 | 135 |
| 140 | 10 | 8.1 | 6.9 | 9.3 | 7.8 | 6.7 | 8.3 | 7.3 | 6.5 | 7.4 | 6.8 | 6.3 | 7.2 | 6.8 | 6.2 | 140 |
| 145 | 9.8 | 8 | 6.8 | 9.1 | 7.6 | 6.7 | 8.2 | 7.2 | 6.4 | 7.2 | 6.8 | 6.2 | 7.1 | 6.7 | 6.2 | 145 |
| 150 | 9.5 | 7.8 | 6.7 | 9 | 7.5 | 6.6 | 8.1 | 7.1 | 6.4 | 7.1 | 6.7 | 6.2 | 7 | 6.6 | 6.2 | 150 |
| 155 | 9.3 | 7.7 | 6.7 | 8.8 | 7.4 | 6.5 | 8 | 7 | 6.4 | 6.9 | 6.6 | 6.1 | 6.9 | 6.5 | 6.1 | 155 |
| 160 | 9.1 | 7.5 | 6.6 | 8.6 | 7.3 | 6.5 | 7.8 | 6.9 | 6.3 | 6.8 | 6.4 | 6.1 | 6.7 | 6.4 | 6.1 | 160 |
| 165 | 8.9 | 7.4 | 6.6 | 8.5 | 7.2 | 6.5 | 7.6 | 6.8 | 6.3 | 6.7 | 6.3 | 6 | 6.6 | 6.3 | 6 | 165 |
| 170 | 8.7 | 7.3 | 6.5 | 8.3 | 7.1 | 6.4 | 7.4 | 6.7 | 6.2 | 6.5 | 6.2 | 6 | 6.4 | 6.1 | 5.9 | 170 |
| 175 | 8.5 | 7.2 | 6.5 | 8.1 | 7 | 6.4 | 7.3 | 6.7 | 6.2 | 6.3 | 6 | 5.9 | 6.3 | 6 | 5.9 | 175 |
| 180 | 8.3 | 7.1 | 6.5 | 8 | 6.9 | 6.4 | 7.1 | 6.6 | 6.2 | 6.1 | 5.9 | 5.8 | 6.1 | 5.9 | 5.8 | 180 |
| 185 | 8.1 | 7 | 6.4 | 7.8 | 6.8 | 6.3 | 6.9 | 6.5 | 6.2 | 6 | 5.7 | 5.7 | 5.9 | 5.7 | 5.7 | 185 |
| 190 | 8 | 6.9 | 6.4 | 7.7 | 6.7 | 6.3 | 6.8 | 6.4 | 6.2 | 5.8 | 5.6 | 5.6 | 5.7 | 5.6 | 5.5 | 190 |
| 195 | 7.8 | 6.8 | 6.4 | 7.5 | 6.7 | 6.3 | 6.6 | 6.3 | 6.1 | 5.6 | 5.5 | 5.5 | 5.5 | 5.5 | 5.4 | 195 |
| 200 | 7.7 | 6.7 | 6.4 | 7.4 | 6.6 | 6.3 | 6.5 | 6.2 | 6.1 | 5.4 | 5.4 | 5.4 | 5.3 | 5.4 | 5.3 | 200 |
| 205 | 7.5 | 6.7 | 6.4 | 7.2 | 6.5 | 6.3 | 6.3 | 6 | 6 | 5.2 | 5.3 | 5.3 | 5.2 | 5.3 | 5.2 | 205 |
| 210 | 7.4 | 6.6 | 6.4 | 7.1 | 6.5 | 6.3 | 6.2 | 5.9 | 5.9 | 5 | 5.1 | 5.2 | 5 | 5.1 | 5.2 | 210 |
| 215 | 7.2 | 6.6 | 6.4 | 6.9 | 6.5 | 6.3 | 6.1 | 5.8 | 5.8 | 4.8 | 5 | 5.1 | 4.8 | 5 | 5.1 | 215 |
| 220 | 7.1 | 6.5 | 6.4 | 6.8 | 6.4 | 6.3 | 5.9 | 5.7 | 5.7 | 4.6 | 4.8 | 5 | 4.6 | 4.8 | 4.9 | 220 |
| 225 | 6.9 | 6.5 | 6.4 | 6.6 | 6.4 | 6.3 | 5.8 | 5.6 | 5.6 | 4.5 | 4.7 | 4.8 | 4.5 | 4.7 | 4.8 | 225 |
| 230 | 6.8 | 6.5 | 6.4 | 6.5 | 6.3 | 6.3 | 5.6 | 5.5 | 5.6 | 4.3 | 4.5 | 4.7 | 4.3 | 4.5 | 4.7 | 230 |
| 235 | 6.7 | 6.4 | 6.4 | 6.3 | 6.2 | 6.3 | 5.4 | 5.4 | 5.5 | 4.1 | 4.3 | 4.6 | 4.1 | 4.3 | 4.6 | 235 |
| 240 | 6.4 | 6.4 | 6.4 | 6 | 6.1 | 6.3 | 5.3 | 5.3 | 5.4 | 3.9 | 4.2 | 4.4 | 3.8 | 4.1 | 4.4 | 240 |
| 245 | 6 | 6.3 | 6.4 | 5.8 | 6 | 6.2 | 5.1 | 5.2 | 5.3 | 3.8 | 4 | 4.3 | 3.6 | 4 | 4.3 | 245 |
| 250 | 5.6 | 6.1 | 6.4 | 5.5 | 5.8 | 6.1 | 4.9 | 5 | 5.2 | 3.6 | 3.9 | 4.1 | 3.3 | 3.8 | 4.1 | 250 |
| 255 | 5.4 | 5.8 | 6 | 5.1 | 5.6 | 5.8 | 4.7 | 4.9 | 5.1 | 3.5 | 3.7 | 3.9 | 3 | 3.6 | 3.9 | 255 |
| 260 | 5.2 | 5.4 | 5.5 | 4.6 | 5.4 | 5.5 | 4.5 | 4.8 | 4.9 | 3.3 | 3.6 | 3.8 | 2.8 | 3.3 | 3.7 | 260 |
| 265 | 5.1 | 5.2 | | 4.4 | 5 | 5.2 | 4.2 | 4.6 | 4.8 | 3.1 | 3.4 | 3.6 | | 3.1 | 3.3 | 265 |
| 270 | 4.9 | 5 | | 4.2 | 4.4 | 4.6 | 3.9 | 4.5 | 4.6 | | 3.2 | 3.4 | | 2.8 | 3 | 270 |
| 275 | 3.7 | 4.8 | | 4.1 | 4.2 | 4.4 | 3.4 | 4.2 | 4.4 | | 3 | 3.2 | | 2.5 | 2.7 | 275 |
| 280 | | 3.6 | | 4 | 4.1 | | 2.8 | 3.8 | 4 | | 2.8 | 3 | | | 2.3 | 280 |
| 285 | | | | 3.8 | 3.9 | | | 3.3 | 3.4 | | | 2.6 | | | | 285 |
| 290 | | | | 2.3 | 3.8 | | | 2.4 | 2.5 | | | | | | | 290 |

t_240_002_50401_00_000 / 52401_00_000 / 54401_00_000

Lifting heights Hauteurs de levage

TK

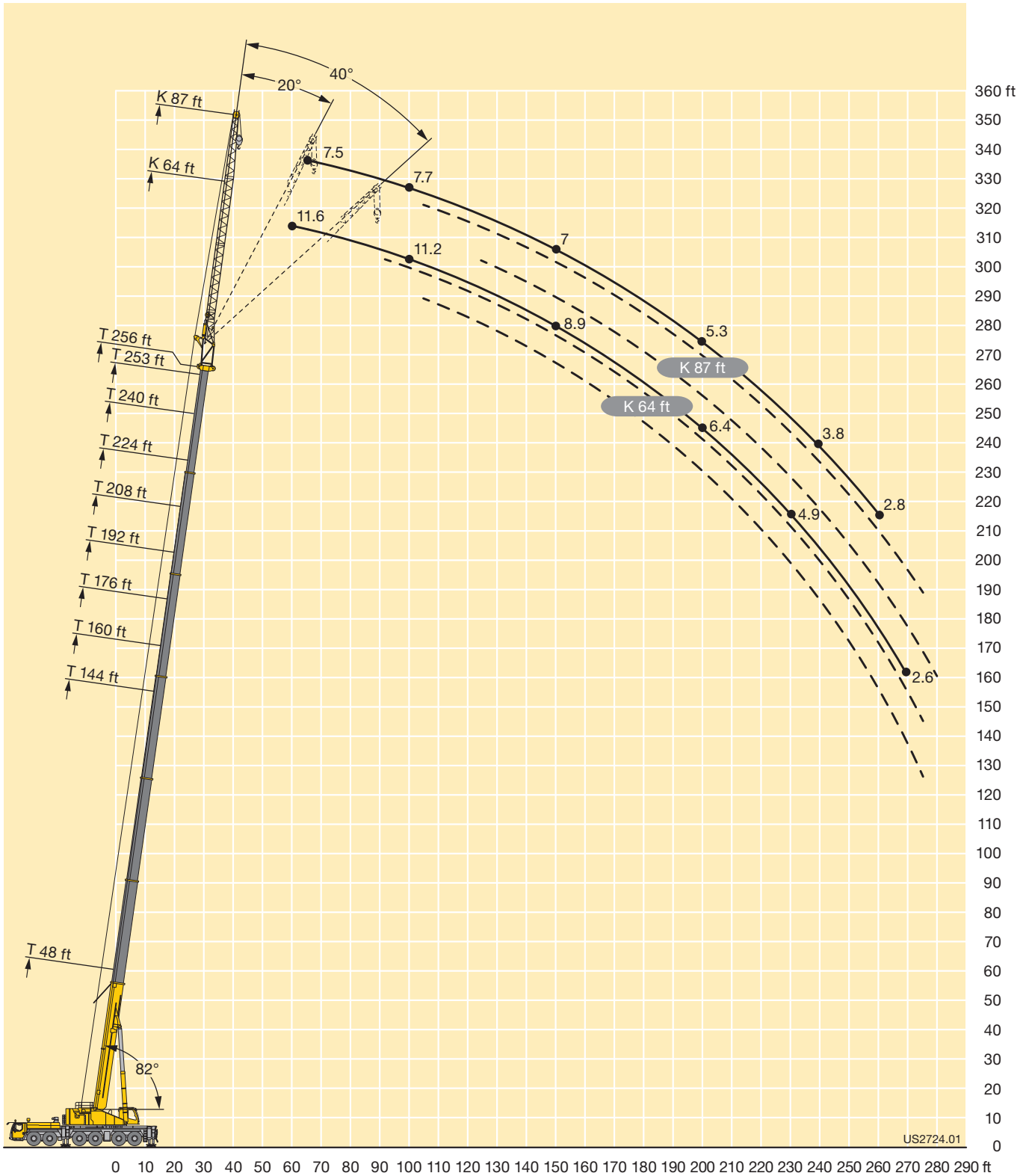

Lifting capacities Forces de levage

TK



| ft | 48 ft | | | 144 ft | | | 160 ft | | | 176 ft | | | 192 ft | | | ft |
|-----|-------|------|-----|--------|------|-----|--------|------|-----|--------|------|-----|--------|------|-----|-----|
| | 92 ft | | | 92 ft | | | 92 ft | | | 92 ft | | | 92 ft | | | |
| | 0° | 20° | 40° | 0° | 20° | 40° | 0° | 20° | 40° | 0° | 20° | 40° | 0° | 20° | 40° | |
| 15 | 15.9 | | | | | | | | | | | | | | | 15 |
| 16 | 15.9 | | | | | | | | | | | | | | | 16 |
| 17 | 15.9 | | | | | | | | | | | | | | | 17 |
| 18 | 15.9 | | | | | | | | | | | | | | | 18 |
| 19 | 15.9 | | | | | | | | | | | | | | | 19 |
| 20 | 16 | | | | | | | | | | | | | | | 20 |
| 22 | 15.9 | | | | | | | | | | | | | | | 22 |
| 24 | 15.9 | | | | | | | | | | | | | | | 24 |
| 26 | 15.8 | | | | | | | | | | | | | | | 26 |
| 28 | 15.6 | | | | | | | | | | | | | | | 28 |
| 30 | 15.4 | | | | | | | | | | | | | | | 30 |
| 32 | 15.2 | | | 15.4 | | | | | | | | | | | | 32 |
| 34 | 15 | | | 15.8 | | | | | | | | | | | | 34 |
| 36 | 14.8 | | | 15.9 | | | 14.9 | | | | | | | | | 36 |
| 38 | 14.5 | | | 16 | | | 15.1 | | | | | | | | | 38 |
| 40 | 14.3 | | | 15.9 | | | 15.2 | | | 14.1 | | | | | | 40 |
| 45 | 13.7 | | | 15.9 | | | 15.2 | | | 14.2 | | | 12.9 | | | 45 |
| 50 | 13.1 | 11.6 | | 15.7 | | | 15 | | | 14.2 | | | 13 | | | 50 |
| 55 | 12.5 | 10.9 | | 15.4 | | | 14.8 | | | 14 | | | 13 | | | 55 |
| 60 | 11.9 | 10.3 | | 15.1 | | | 14.6 | | | 13.8 | | | 12.9 | | | 60 |
| 65 | 11.2 | 9.7 | | 14.8 | 12 | | 14.3 | | | 13.6 | | | 12.7 | | | 65 |
| 70 | 10.6 | 9.2 | 7.8 | 14.4 | 11.6 | | 14 | 11.5 | | 13.3 | | | 12.5 | | | 70 |
| 75 | 10.1 | 8.8 | 7.5 | 14.1 | 11.2 | | 13.7 | 11.1 | | 13.1 | 10.9 | | 12.3 | | | 75 |
| 80 | 9.5 | 8.3 | 7.2 | 13.7 | 10.8 | | 13.4 | 10.7 | | 12.8 | 10.5 | | 12.1 | 10.2 | | 80 |
| 85 | 9 | 8 | 7 | 13.4 | 10.5 | | 13.1 | 10.4 | | 12.6 | 10.2 | | 11.9 | 9.9 | | 85 |
| 90 | 8.5 | 7.6 | 6.8 | 13 | 10.1 | 7.8 | 12.8 | 10.1 | 7.8 | 12.3 | 9.9 | | 11.6 | 9.7 | | 90 |
| 95 | 8.1 | 7.3 | 6.7 | 12.6 | 9.8 | 7.6 | 12.5 | 9.8 | 7.6 | 12.1 | 9.7 | 7.5 | 11.4 | 9.4 | | 95 |
| 100 | 7.7 | 7 | 6.5 | 12.3 | 9.5 | 7.5 | 12.2 | 9.5 | 7.4 | 11.8 | 9.4 | 7.4 | 11.2 | 9.2 | 7.2 | 100 |
| 105 | 7.3 | 6.8 | 6.4 | 11.9 | 9.2 | 7.3 | 11.9 | 9.3 | 7.3 | 11.5 | 9.1 | 7.2 | 11 | 8.9 | 7.1 | 105 |
| 110 | 7 | 6.6 | 6.3 | 11.5 | 9 | 7.2 | 11.5 | 9 | 7.2 | 11.3 | 8.9 | 7.1 | 10.8 | 8.7 | 7 | 110 |
| 115 | 6.7 | 6.5 | 6.3 | 11.2 | 8.7 | 7.1 | 11.2 | 8.8 | 7.1 | 11 | 8.7 | 7 | 10.6 | 8.5 | 6.9 | 115 |
| 120 | 6.5 | 6.4 | 6.3 | 10.8 | 8.5 | 7 | 10.9 | 8.5 | 6.9 | 10.7 | 8.5 | 6.9 | 10.4 | 8.3 | 6.8 | 120 |
| 125 | 6.2 | 6.3 | 6.3 | 10.5 | 8.2 | 6.9 | 10.6 | 8.3 | 6.8 | 10.4 | 8.3 | 6.8 | 10.1 | 8.1 | 6.7 | 125 |
| 130 | 6 | 6.3 | | 10.1 | 8 | 6.8 | 10.3 | 8.1 | 6.7 | 10.2 | 8.1 | 6.7 | 9.9 | 8 | 6.6 | 130 |
| 135 | | | | 9.8 | 7.8 | 6.7 | 9.9 | 7.9 | 6.7 | 9.9 | 7.9 | 6.6 | 9.7 | 7.8 | 6.6 | 135 |
| 140 | | | | 9.4 | 7.6 | 6.6 | 9.7 | 7.7 | 6.6 | 9.7 | 7.7 | 6.6 | 9.4 | 7.6 | 6.5 | 140 |
| 145 | | | | 9.1 | 7.4 | 6.5 | 9.3 | 7.5 | 6.5 | 9.4 | 7.5 | 6.5 | 9.2 | 7.5 | 6.4 | 145 |
| 150 | | | | 8.8 | 7.3 | 6.5 | 9.1 | 7.4 | 6.4 | 9.1 | 7.4 | 6.4 | 9 | 7.3 | 6.4 | 150 |
| 155 | | | | 8.5 | 7.2 | 6.4 | 8.8 | 7.2 | 6.4 | 8.9 | 7.3 | 6.4 | 8.8 | 7.2 | 6.3 | 155 |
| 160 | | | | 8.3 | 7 | 6.4 | 8.6 | 7.1 | 6.3 | 8.6 | 7.1 | 6.3 | 8.6 | 7 | 6.3 | 160 |
| 165 | | | | 8 | 6.9 | 6.3 | 8.3 | 7 | 6.3 | 8.4 | 7 | 6.2 | 8.4 | 6.9 | 6.2 | 165 |
| 170 | | | | 7.8 | 6.8 | 6.3 | 8.1 | 6.9 | 6.3 | 8.2 | 6.9 | 6.2 | 8.2 | 6.8 | 6.1 | 170 |
| 175 | | | | 7.6 | 6.7 | 6.3 | 7.8 | 6.7 | 6.2 | 8 | 6.8 | 6.2 | 7.9 | 6.7 | 6.1 | 175 |
| 180 | | | | 7.4 | 6.6 | 6.3 | 7.6 | 6.7 | 6.2 | 7.8 | 6.7 | 6.1 | 7.8 | 6.6 | 6.1 | 180 |
| 185 | | | | 7.2 | 6.5 | 6.3 | 7.5 | 6.6 | 6.2 | 7.6 | 6.6 | 6.1 | 7.6 | 6.6 | 6.1 | 185 |
| 190 | | | | 7 | 6.4 | 6.3 | 7.3 | 6.5 | 6.2 | 7.4 | 6.5 | 6.1 | 7.4 | 6.5 | 6 | 190 |
| 195 | | | | 6.8 | 6.4 | 6.3 | 7.1 | 6.4 | 6.2 | 7.2 | 6.4 | 6.1 | 7.3 | 6.4 | 6 | 195 |
| 200 | | | | 6.7 | 6.3 | 6.3 | 7 | 6.4 | 6.2 | 7.1 | 6.4 | 6.1 | 7.1 | 6.4 | 6 | 200 |
| 205 | | | | 6.5 | 6.3 | 6.3 | 6.8 | 6.3 | 6.2 | 7 | 6.3 | 6.1 | 7 | 6.3 | 6 | 205 |
| 210 | | | | 6.4 | 6.3 | 5.4 | 6.7 | 6.3 | 6.2 | 6.8 | 6.3 | 6.1 | 6.9 | 6.2 | 6 | 210 |
| 215 | | | | 6.2 | 6.3 | | 6.6 | 6.2 | 6.2 | 6.7 | 6.2 | 6.1 | 6.8 | 6.2 | 6 | 215 |
| 220 | | | | 6.1 | 6.3 | | 6.4 | 6.2 | 6.2 | 6.6 | 6.2 | 6.1 | 6.7 | 6.1 | 6 | 220 |
| 225 | | | | 5.7 | 6.3 | | 6.3 | 6.2 | 5.1 | 6.5 | 6.2 | 6.1 | 6.6 | 6.1 | 6 | 225 |
| 230 | | | | | | | 6.2 | 6.2 | | 6.4 | 6.2 | 6.1 | 6.5 | 6.1 | 6 | 230 |
| 235 | | | | | | | 6.1 | 6.2 | | 6.3 | 6.2 | 6 | 6.4 | 6.1 | 6 | 235 |
| 240 | | | | | | | 4.1 | 6.2 | | 6.2 | 6.2 | | 6.3 | 6.1 | 6 | 240 |
| 245 | | | | | | | | | | 6.1 | 6.2 | | 6.2 | 6.1 | 6 | 245 |
| 250 | | | | | | | | | | 5.4 | 6.2 | | 6.1 | 6.1 | 5.7 | 250 |
| 255 | | | | | | | | | | 2.6 | 4.9 | | 6 | 6 | | 255 |
| 260 | | | | | | | | | | | | | 5.9 | 6 | | 260 |
| 265 | | | | | | | | | | | | | 4.1 | 6 | | 265 |
| 270 | | | | | | | | | | | | | 3.8 | 3.9 | | 270 |

t_240_002_50501_00_000 / 52501_00_000 / 54501_00_000

Lifting capacities Forces de levage

TK

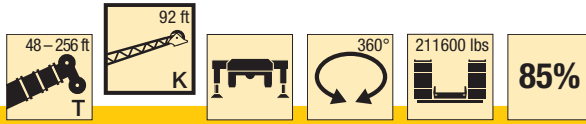

| ft | 208 ft | | | 224 ft | | | 240 ft | | | 253 ft | | | 256 ft | | | ft |
|-----|--------|-----|-----|--------|-----|-----|--------|-----|-----|--------|-----|-----|--------|-----|-----|-----|
| | 92 ft | | | 92 ft | | | 92 ft | | | 92 ft | | | 92 ft | | | |
| | 0° | 20° | 40° | 0° | 20° | 40° | 0° | 20° | 40° | 0° | 20° | 40° | 0° | 20° | 40° | |
| 50 | 11.5 | | | | | | | | | | | | | | | 50 |
| 55 | 11.5 | | | 9.9 | | | | | | | | | | | | 55 |
| 60 | 11.5 | | | 10.1 | | | 8.2 | | | | | | | | | 60 |
| 65 | 11.5 | | | 10.2 | | | 8.5 | | | 6.9 | | | | | | 65 |
| 70 | 11.4 | | | 10.1 | | | 8.7 | | | 7.2 | | | 6.9 | | | 70 |
| 75 | 11.2 | | | 10 | | | 8.7 | | | 7.4 | | | 7.1 | | | 75 |
| 80 | 11.1 | | | 9.9 | | | 8.6 | | | 7.5 | | | 7.3 | | | 80 |
| 85 | 10.9 | 9.4 | | 9.8 | | | 8.5 | | | 7.5 | | | 7.3 | | | 85 |
| 90 | 10.7 | 9.2 | | 9.7 | 8.5 | | 8.4 | | | 7.5 | | | 7.3 | | | 90 |
| 95 | 10.6 | 9 | | 9.6 | 8.4 | | 8.4 | | | 7.4 | | | 7.3 | | | 95 |
| 100 | 10.4 | 8.8 | | 9.4 | 8.2 | | 8.3 | 7.5 | | 7.4 | | | 7.3 | | | 100 |
| 105 | 10.3 | 8.6 | | 9.3 | 8.1 | | 8.2 | 7.4 | | 7.3 | 6.9 | | 7.2 | 6.8 | | 105 |
| 110 | 10.1 | 8.4 | 6.9 | 9.2 | 7.9 | | 8.1 | 7.3 | | 7.3 | 6.8 | | 7.1 | 6.8 | | 110 |
| 115 | 9.9 | 8.2 | 6.8 | 9.1 | 7.7 | 6.6 | 8 | 7.2 | | 7.2 | 6.8 | | 7.1 | 6.7 | | 115 |
| 120 | 9.7 | 8 | 6.7 | 8.9 | 7.6 | 6.5 | 7.9 | 7.1 | 6.2 | 7.2 | 6.7 | | 7 | 6.6 | | 120 |
| 125 | 9.6 | 7.9 | 6.6 | 8.8 | 7.5 | 6.4 | 7.8 | 7 | 6.2 | 7.1 | 6.6 | | 7 | 6.5 | | 125 |
| 130 | 9.4 | 7.7 | 6.5 | 8.7 | 7.3 | 6.3 | 7.7 | 6.9 | 6.1 | 7 | 6.5 | 5.9 | 6.9 | 6.4 | 5.8 | 130 |
| 135 | 9.2 | 7.6 | 6.4 | 8.6 | 7.2 | 6.3 | 7.7 | 6.8 | 6.1 | 7 | 6.4 | 5.9 | 6.9 | 6.4 | 5.8 | 135 |
| 140 | 9 | 7.4 | 6.4 | 8.4 | 7.1 | 6.2 | 7.6 | 6.7 | 6 | 6.9 | 6.4 | 5.8 | 6.8 | 6.3 | 5.8 | 140 |
| 145 | 8.8 | 7.3 | 6.3 | 8.3 | 7 | 6.2 | 7.5 | 6.6 | 6 | 6.8 | 6.3 | 5.8 | 6.7 | 6.2 | 5.8 | 145 |
| 150 | 8.7 | 7.1 | 6.3 | 8.1 | 6.9 | 6.1 | 7.4 | 6.5 | 5.9 | 6.7 | 6.2 | 5.7 | 6.6 | 6.2 | 5.7 | 150 |
| 155 | 8.5 | 7 | 6.2 | 8 | 6.8 | 6.1 | 7.3 | 6.5 | 5.9 | 6.6 | 6.2 | 5.7 | 6.5 | 6.1 | 5.7 | 155 |
| 160 | 8.3 | 6.9 | 6.1 | 7.9 | 6.7 | 6 | 7.2 | 6.4 | 5.9 | 6.5 | 6.1 | 5.7 | 6.4 | 6.1 | 5.7 | 160 |
| 165 | 8.1 | 6.8 | 6.1 | 7.7 | 6.6 | 6 | 7.1 | 6.3 | 5.8 | 6.4 | 6 | 5.7 | 6.4 | 6 | 5.6 | 165 |
| 170 | 7.9 | 6.7 | 6.1 | 7.6 | 6.5 | 5.9 | 7 | 6.3 | 5.8 | 6.3 | 5.9 | 5.6 | 6.2 | 5.9 | 5.6 | 170 |
| 175 | 7.8 | 6.7 | 6 | 7.4 | 6.4 | 5.9 | 6.9 | 6.2 | 5.8 | 6.2 | 5.8 | 5.6 | 6.1 | 5.8 | 5.6 | 175 |
| 180 | 7.6 | 6.6 | 6 | 7.3 | 6.4 | 5.9 | 6.8 | 6.1 | 5.7 | 6 | 5.7 | 5.6 | 6 | 5.7 | 5.6 | 180 |
| 185 | 7.4 | 6.5 | 6 | 7.2 | 6.3 | 5.9 | 6.7 | 6.1 | 5.7 | 5.8 | 5.6 | 5.5 | 5.8 | 5.6 | 5.5 | 185 |
| 190 | 7.3 | 6.4 | 5.9 | 7.1 | 6.2 | 5.8 | 6.6 | 6 | 5.7 | 5.7 | 5.5 | 5.4 | 5.6 | 5.5 | 5.4 | 190 |
| 195 | 7.1 | 6.3 | 5.9 | 7 | 6.2 | 5.8 | 6.5 | 6 | 5.7 | 5.5 | 5.4 | 5.3 | 5.5 | 5.4 | 5.3 | 195 |
| 200 | 7 | 6.3 | 5.9 | 6.8 | 6.1 | 5.8 | 6.3 | 5.9 | 5.7 | 5.3 | 5.3 | 5.3 | 5.3 | 5.3 | 5.2 | 200 |
| 205 | 6.9 | 6.2 | 5.9 | 6.7 | 6.1 | 5.8 | 6.2 | 5.8 | 5.7 | 5.1 | 5.2 | 5.2 | 5.1 | 5.1 | 5.2 | 205 |
| 210 | 6.8 | 6.2 | 5.9 | 6.6 | 6 | 5.8 | 6.1 | 5.7 | 5.7 | 5 | 5 | 5.1 | 4.9 | 5 | 5.1 | 210 |
| 215 | 6.7 | 6.1 | 5.9 | 6.5 | 6 | 5.8 | 5.9 | 5.6 | 5.6 | 4.8 | 4.9 | 5 | 4.8 | 4.9 | 5 | 215 |
| 220 | 6.6 | 6 | 5.9 | 6.5 | 5.9 | 5.8 | 5.8 | 5.5 | 5.6 | 4.6 | 4.8 | 4.9 | 4.6 | 4.7 | 4.9 | 220 |
| 225 | 6.5 | 6 | 5.9 | 6.4 | 5.9 | 5.8 | 5.7 | 5.5 | 5.5 | 4.5 | 4.6 | 4.8 | 4.4 | 4.6 | 4.8 | 225 |
| 230 | 6.4 | 6 | 5.9 | 6.3 | 5.9 | 5.8 | 5.5 | 5.4 | 5.4 | 4.3 | 4.5 | 4.7 | 4.3 | 4.5 | 4.7 | 230 |
| 235 | 6.4 | 6 | 5.9 | 6.2 | 5.8 | 5.8 | 5.4 | 5.3 | 5.4 | 4.1 | 4.3 | 4.6 | 4.1 | 4.3 | 4.5 | 235 |
| 240 | 6.3 | 5.9 | 5.9 | 6 | 5.8 | 5.8 | 5.2 | 5.2 | 5.3 | 4 | 4.2 | 4.5 | 3.9 | 4.1 | 4.4 | 240 |
| 245 | 6.1 | 5.9 | 5.9 | 5.8 | 5.7 | 5.8 | 5.1 | 5.1 | 5.2 | 3.8 | 4 | 4.3 | 3.7 | 4 | 4.3 | 245 |
| 250 | 5.8 | 5.9 | 5.9 | 5.6 | 5.7 | 5.8 | 4.9 | 5 | 5.1 | 3.7 | 3.9 | 4.1 | 3.4 | 3.8 | 4.1 | 250 |
| 255 | 5.4 | 5.8 | 5.9 | 5.3 | 5.6 | 5.8 | 4.7 | 4.9 | 5 | 3.5 | 3.7 | 4 | 3.2 | 3.6 | 4 | 255 |
| 260 | 5.3 | 5.6 | 5.8 | 4.9 | 5.5 | 5.7 | 4.5 | 4.7 | 4.9 | 3.3 | 3.6 | 3.8 | 2.9 | 3.4 | 3.8 | 260 |
| 265 | 5.1 | 5.2 | 5.3 | 4.4 | 5.2 | 5.4 | 4.3 | 4.6 | 4.8 | 3.2 | 3.4 | 3.6 | 2.6 | 3.2 | 3.5 | 265 |
| 270 | 4.9 | 5.1 | | 4.2 | 4.8 | 5 | 4.1 | 4.5 | 4.6 | 3 | 3.3 | 3.5 | 2.4 | 3 | 3.2 | 270 |
| 275 | 4.7 | 4.9 | | 4.1 | 4.2 | 4.4 | 3.7 | 4.3 | 4.4 | 2.7 | 3.1 | 3.3 | | 2.7 | 2.9 | 275 |
| 280 | 3.6 | 4.7 | | 3.9 | 4.1 | 4.2 | 3.2 | 4.1 | 4.2 | | 2.9 | 3.1 | | 2.4 | 2.5 | 280 |
| 285 | | 3.5 | | 3.8 | 4 | | 2.8 | 3.7 | 3.8 | | 2.8 | 3 | | | 2.2 | 285 |
| 290 | | | | 3.6 | 3.8 | | 2.1 | 3.1 | 3.3 | | | 2.7 | | | | 290 |
| 295 | | | | | 3.6 | | | 2.6 | 2.7 | | | | | | | 295 |

t_240_002_50501_00_000 / 52501_00_000 / 54501_00_000

Lifting capacities Forces de levage

TK

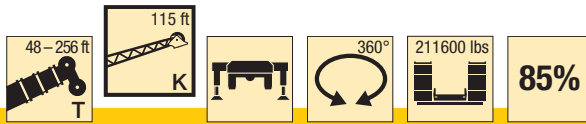

| ft | 48 ft | | | 144 ft | | | 160 ft | | | 176 ft | | | 192 ft | | | ft |
|-----|--------|-----|-----|--------|-----|-----|--------|-----|-----|--------|-----|-----|--------|-----|-----|-----|
| | 115 ft | | | 115 ft | | | 115 ft | | | 115 ft | | | 115 ft | | | |
| | 0° | 20° | 40° | 0° | 20° | 40° | 0° | 20° | 40° | 0° | 20° | 40° | 0° | 20° | 40° | |
| 19 | 9.1 | | | | | | | | | | | | | | | 19 |
| 20 | 9.1 | | | | | | | | | | | | | | | 20 |
| 22 | 9.2 | | | | | | | | | | | | | | | 22 |
| 24 | 10.1 | | | | | | | | | | | | | | | 24 |
| 26 | 10.8 | | | | | | | | | | | | | | | 26 |
| 28 | 11.2 | | | | | | | | | | | | | | | 28 |
| 30 | 11.1 | | | | | | | | | | | | | | | 30 |
| 32 | 10.9 | | | | | | | | | | | | | | | 32 |
| 34 | 10.8 | | | | | | | | | | | | | | | 34 |
| 36 | 10.6 | | | 9.3 | | | | | | | | | | | | 36 |
| 38 | 10.5 | | | 9.7 | | | | | | | | | | | | 38 |
| 40 | 10.3 | | | 10 | | | 9.1 | | | | | | | | | 40 |
| 45 | 9.9 | | | 10.7 | | | 9.8 | | | 8.7 | | | | | | 45 |
| 50 | 9.5 | | | 11 | | | 10.3 | | | 9.2 | | | 7.8 | | | 50 |
| 55 | 9 | | | 10.9 | | | 10.4 | | | 9.6 | | | 8.3 | | | 55 |
| 60 | 8.6 | 7.4 | | 10.7 | | | 10.2 | | | 9.7 | | | 8.7 | | | 60 |
| 65 | 8.2 | 7 | | 10.4 | | | 10 | | | 9.5 | | | 8.8 | | | 65 |
| 70 | 7.7 | 6.6 | | 10.2 | | | 9.8 | | | 9.4 | | | 8.7 | | | 70 |
| 75 | 7.2 | 6.3 | | 9.9 | | | 9.6 | | | 9.2 | | | 8.6 | | | 75 |
| 80 | 6.8 | 6 | | 9.7 | 7.3 | | 9.4 | 7.2 | | 9 | | | 8.4 | | | 80 |
| 85 | 6.5 | 5.7 | | 9.4 | 7.1 | | 9.2 | 7 | | 8.8 | 6.9 | | 8.2 | | | 85 |
| 90 | 6.1 | 5.5 | 4.8 | 9.1 | 6.9 | | 8.9 | 6.8 | | 8.6 | 6.7 | | 8.1 | 6.4 | | 90 |
| 95 | 5.8 | 5.2 | 4.6 | 8.8 | 6.6 | | 8.7 | 6.6 | | 8.4 | 6.5 | | 7.9 | 6.3 | | 95 |
| 100 | 5.6 | 5 | 4.5 | 8.6 | 6.4 | | 8.4 | 6.4 | | 8.2 | 6.3 | | 7.7 | 6.2 | | 100 |
| 105 | 5.3 | 4.8 | 4.3 | 8.3 | 6.2 | 4.6 | 8.2 | 6.2 | | 7.9 | 6.1 | | 7.5 | 6 | | 105 |
| 110 | 5.1 | 4.6 | 4.2 | 8 | 6.1 | 4.5 | 7.9 | 6 | 4.5 | 7.7 | 6 | | 7.4 | 5.8 | | 110 |
| 115 | 4.9 | 4.4 | 4.1 | 7.7 | 5.9 | 4.5 | 7.7 | 5.9 | 4.5 | 7.5 | 5.8 | 4.4 | 7.2 | 5.7 | | 115 |
| 120 | 4.7 | 4.3 | 3.9 | 7.4 | 5.7 | 4.4 | 7.4 | 5.7 | 4.4 | 7.3 | 5.7 | 4.3 | 7 | 5.6 | 4.3 | 120 |
| 125 | 4.5 | 4.1 | 3.9 | 7.1 | 5.6 | 4.4 | 7.2 | 5.6 | 4.3 | 7.1 | 5.5 | 4.3 | 6.8 | 5.4 | 4.2 | 125 |
| 130 | 4.3 | 4 | 3.8 | 6.9 | 5.4 | 4.3 | 6.9 | 5.4 | 4.3 | 6.9 | 5.4 | 4.2 | 6.7 | 5.3 | 4.2 | 130 |
| 135 | 4.2 | 3.9 | 3.8 | 6.6 | 5.3 | 4.2 | 6.7 | 5.3 | 4.2 | 6.7 | 5.3 | 4.2 | 6.5 | 5.2 | 4.1 | 135 |
| 140 | 4 | 3.8 | 3.8 | 6.4 | 5.1 | 4.2 | 6.5 | 5.2 | 4.2 | 6.5 | 5.1 | 4.2 | 6.3 | 5.1 | 4.1 | 140 |
| 145 | 3.9 | 3.8 | 3.8 | 6.2 | 5 | 4.2 | 6.3 | 5 | 4.2 | 6.3 | 5 | 4.1 | 6.2 | 5 | 4 | 145 |
| 150 | 3.8 | 3.8 | | 6 | 4.9 | 4.1 | 6.1 | 4.9 | 4.1 | 6.1 | 4.9 | 4.1 | 6 | 4.8 | 4 | 150 |
| 155 | 3.7 | 3.8 | | 5.8 | 4.8 | 4.1 | 5.9 | 4.8 | 4 | 6 | 4.8 | 4 | 5.9 | 4.7 | 4 | 155 |
| 160 | | | | 5.7 | 4.6 | 4 | 5.8 | 4.7 | 4 | 5.8 | 4.7 | 4 | 5.7 | 4.6 | 3.9 | 160 |
| 165 | | | | 5.5 | 4.6 | 3.9 | 5.6 | 4.6 | 3.9 | 5.7 | 4.6 | 3.9 | 5.6 | 4.6 | 3.9 | 165 |
| 170 | | | | 5.3 | 4.5 | 3.9 | 5.5 | 4.5 | 3.9 | 5.5 | 4.5 | 3.9 | 5.5 | 4.5 | 3.8 | 170 |
| 175 | | | | 5.2 | 4.4 | 3.9 | 5.3 | 4.4 | 3.8 | 5.3 | 4.4 | 3.8 | 5.3 | 4.4 | 3.8 | 175 |
| 180 | | | | 5 | 4.3 | 3.8 | 5.2 | 4.3 | 3.8 | 5.2 | 4.3 | 3.8 | 5.2 | 4.3 | 3.7 | 180 |
| 185 | | | | 4.9 | 4.2 | 3.8 | 5 | 4.2 | 3.8 | 5.1 | 4.3 | 3.7 | 5.1 | 4.2 | 3.7 | 185 |
| 190 | | | | 4.8 | 4.1 | 3.8 | 4.9 | 4.2 | 3.8 | 5 | 4.2 | 3.7 | 4.9 | 4.2 | 3.7 | 190 |
| 195 | | | | 4.7 | 4 | 3.8 | 4.8 | 4.1 | 3.7 | 4.9 | 4.1 | 3.7 | 4.8 | 4.1 | 3.6 | 195 |
| 200 | | | | 4.5 | 4 | 3.8 | 4.7 | 4 | 3.7 | 4.7 | 4 | 3.7 | 4.7 | 4 | 3.6 | 200 |
| 205 | | | | 4.4 | 3.9 | 3.8 | 4.6 | 4 | 3.7 | 4.6 | 4 | 3.6 | 4.6 | 4 | 3.6 | 205 |
| 210 | | | | 4.3 | 3.9 | 3.8 | 4.4 | 3.9 | 3.7 | 4.5 | 3.9 | 3.6 | 4.5 | 3.9 | 3.6 | 210 |
| 215 | | | | 4.2 | 3.8 | 3.8 | 4.3 | 3.9 | 3.7 | 4.4 | 3.9 | 3.6 | 4.4 | 3.8 | 3.6 | 215 |
| 220 | | | | 4.1 | 3.8 | 3.8 | 4.2 | 3.8 | 3.7 | 4.3 | 3.8 | 3.6 | 4.3 | 3.8 | 3.6 | 220 |
| 225 | | | | 4 | 3.8 | 3.8 | 4.2 | 3.8 | 3.7 | 4.3 | 3.8 | 3.6 | 4.2 | 3.8 | 3.6 | 225 |
| 230 | | | | 4 | 3.8 | 3.8 | 4.1 | 3.7 | 3.7 | 4.2 | 3.7 | 3.6 | 4.2 | 3.7 | 3.6 | 230 |
| 235 | | | | 3.9 | 3.8 | | 4 | 3.7 | 3.7 | 4.1 | 3.7 | 3.6 | 4.1 | 3.7 | 3.6 | 235 |
| 240 | | | | 3.8 | 3.8 | | 3.9 | 3.7 | 3.7 | 4 | 3.7 | 3.6 | 4 | 3.6 | 3.6 | 240 |
| 245 | | | | 3.8 | 3.8 | | 3.9 | 3.7 | | 3.9 | 3.7 | 3.6 | 4 | 3.6 | 3.6 | 245 |
| 250 | | | | | | | 3.8 | 3.7 | | 3.9 | 3.6 | 3.6 | 3.9 | 3.6 | 3.6 | 250 |
| 255 | | | | | | | 3.7 | 3.7 | | 3.8 | 3.6 | 3.6 | 3.8 | 3.6 | 3.6 | 255 |
| 260 | | | | | | | 3.7 | 3.7 | | 3.7 | 3.6 | | 3.8 | 3.6 | 3.6 | 260 |
| 265 | | | | | | | | | | 3.7 | 3.6 | | 3.7 | 3.6 | 3.6 | 265 |
| 270 | | | | | | | | | | 3.7 | 3.6 | | 3.7 | 3.6 | 3.6 | 270 |
| 275 | | | | | | | | | | 2.5 | 3.6 | | 3.6 | 3.6 | | 275 |
| 280 | | | | | | | | | | | | | 3.6 | 3.6 | | 280 |
| 285 | | | | | | | | | | | | | 3.3 | 3.6 | | 285 |
| 290 | | | | | | | | | | | | | 2.4 | 3.4 | | 290 |
| 295 | | | | | | | | | | | | | | 2.5 | | 295 |

t_240_002_50601_00_000 / 52601_00_000 / 54601_00_000

Lifting capacities Forces de levage

TK

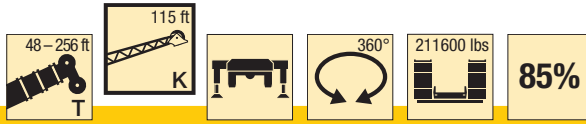

| ft | 208 ft | | | 224 ft | | | 240 ft | | | 253 ft | | | 256 ft | | ft |
|-----|--------|-----|-----|--------|-----|-----|--------|-----|-----|--------|-----|-----|--------|-----|-----|
| | 115 ft | | | 115 ft | | | 115 ft | | | 115 ft | | | 115 ft | | |
| | 0° | 20° | 40° | 0° | 20° | 40° | 0° | 20° | 40° | 0° | 20° | 40° | 0° | 20° | |
| 55 | 6.7 | | | | | | | | | | | | | | 55 |
| 60 | 7.1 | | | 5.6 | | | | | | | | | | | 60 |
| 65 | 7.5 | | | 5.9 | | | 4.6 | | | | | | | | 65 |
| 70 | 7.6 | | | 6.3 | | | 4.8 | | | | | | | | 70 |
| 75 | 7.7 | | | 6.5 | | | 5.1 | | | 4 | | | 3.8 | | 75 |
| 80 | 7.6 | | | 6.6 | | | 5.3 | | | 4 | | | 3.8 | | 80 |
| 85 | 7.5 | | | 6.6 | | | 5.4 | | | 4.1 | | | 3.8 | | 85 |
| 90 | 7.3 | | | 6.6 | | | 5.5 | | | 4.2 | | | 3.8 | | 90 |
| 95 | 7.2 | | | 6.6 | | | 5.6 | | | 4.3 | | | 3.8 | | 95 |
| 100 | 7.1 | 5.9 | | 6.5 | | | 5.6 | | | 4.3 | | | 3.9 | | 100 |
| 105 | 7 | 5.8 | | 6.4 | 5.4 | | 5.6 | | | 4.3 | | | 3.9 | | 105 |
| 110 | 6.8 | 5.6 | | 6.3 | 5.3 | | 5.6 | | | 4.3 | | | 3.9 | | 110 |
| 115 | 6.7 | 5.5 | | 6.2 | 5.2 | | 5.5 | 4.7 | | 4.3 | | | 3.9 | | 115 |
| 120 | 6.6 | 5.4 | | 6.1 | 5.1 | | 5.5 | 4.7 | | 4.4 | 4.2 | | 3.9 | 4.1 | 120 |
| 125 | 6.5 | 5.3 | 4.1 | 6 | 5 | | 5.4 | 4.7 | | 4.4 | 4.2 | | 3.9 | 4.1 | 125 |
| 130 | 6.3 | 5.1 | 4 | 5.9 | 4.9 | | 5.3 | 4.6 | | 4.4 | 4.2 | | 3.9 | 4.1 | 130 |
| 135 | 6.2 | 5 | 4 | 5.8 | 4.8 | 3.8 | 5.3 | 4.5 | | 4.4 | 4.2 | | 3.9 | 4.1 | 135 |
| 140 | 6.1 | 4.9 | 4 | 5.6 | 4.7 | 3.8 | 5.2 | 4.4 | 3.6 | 4.4 | 4.1 | | 3.9 | 4 | 140 |
| 145 | 5.9 | 4.8 | 3.9 | 5.5 | 4.6 | 3.8 | 5.1 | 4.4 | 3.6 | 4.3 | 4.1 | | 3.9 | 4 | 145 |
| 150 | 5.8 | 4.7 | 3.9 | 5.4 | 4.5 | 3.8 | 5 | 4.3 | 3.6 | 4.3 | 4 | 3.4 | 3.9 | 4 | 150 |
| 155 | 5.7 | 4.6 | 3.9 | 5.3 | 4.4 | 3.7 | 4.9 | 4.2 | 3.6 | 4.2 | 4 | 3.4 | 3.9 | 4 | 155 |
| 160 | 5.5 | 4.5 | 3.8 | 5.2 | 4.4 | 3.7 | 4.8 | 4.1 | 3.5 | 4.2 | 3.9 | 3.4 | 3.9 | 3.9 | 160 |
| 165 | 5.4 | 4.4 | 3.8 | 5.1 | 4.3 | 3.7 | 4.8 | 4.1 | 3.5 | 4.2 | 3.9 | 3.3 | 3.9 | 3.9 | 165 |
| 170 | 5.3 | 4.4 | 3.8 | 5 | 4.2 | 3.6 | 4.7 | 4 | 3.5 | 4.1 | 3.8 | 3.3 | 3.8 | 3.8 | 170 |
| 175 | 5.2 | 4.3 | 3.7 | 4.9 | 4.2 | 3.6 | 4.6 | 4 | 3.5 | 4.1 | 3.8 | 3.3 | 3.8 | 3.8 | 175 |
| 180 | 5 | 4.2 | 3.7 | 4.8 | 4.1 | 3.6 | 4.5 | 3.9 | 3.5 | 4 | 3.7 | 3.3 | 3.7 | 3.7 | 180 |
| 185 | 4.9 | 4.1 | 3.6 | 4.7 | 4 | 3.6 | 4.5 | 3.8 | 3.4 | 4 | 3.7 | 3.3 | 3.7 | 3.7 | 185 |
| 190 | 4.8 | 4.1 | 3.6 | 4.7 | 3.9 | 3.5 | 4.4 | 3.8 | 3.4 | 3.9 | 3.6 | 3.3 | 3.7 | 3.6 | 190 |
| 195 | 4.7 | 4 | 3.6 | 4.6 | 3.9 | 3.5 | 4.3 | 3.7 | 3.4 | 3.9 | 3.6 | 3.3 | 3.6 | 3.6 | 195 |
| 200 | 4.6 | 4 | 3.5 | 4.5 | 3.9 | 3.5 | 4.2 | 3.7 | 3.4 | 3.8 | 3.5 | 3.3 | 3.6 | 3.5 | 200 |
| 205 | 4.5 | 3.9 | 3.5 | 4.4 | 3.8 | 3.5 | 4.2 | 3.6 | 3.4 | 3.7 | 3.5 | 3.3 | 3.6 | 3.5 | 205 |
| 210 | 4.4 | 3.8 | 3.5 | 4.3 | 3.8 | 3.4 | 4.1 | 3.6 | 3.4 | 3.7 | 3.5 | 3.3 | 3.5 | 3.4 | 210 |
| 215 | 4.4 | 3.8 | 3.5 | 4.3 | 3.7 | 3.4 | 4 | 3.6 | 3.3 | 3.6 | 3.4 | 3.2 | 3.5 | 3.4 | 215 |
| 220 | 4.3 | 3.7 | 3.5 | 4.2 | 3.7 | 3.4 | 4 | 3.5 | 3.3 | 3.5 | 3.4 | 3.2 | 3.5 | 3.4 | 220 |
| 225 | 4.2 | 3.7 | 3.5 | 4.1 | 3.6 | 3.4 | 3.9 | 3.5 | 3.3 | 3.4 | 3.3 | 3.2 | 3.3 | 3.4 | 225 |
| 230 | 4.1 | 3.7 | 3.5 | 4 | 3.6 | 3.4 | 3.9 | 3.5 | 3.3 | 3.2 | 3.3 | 3.2 | 3.2 | 3.3 | 230 |
| 235 | 4.1 | 3.6 | 3.5 | 4 | 3.5 | 3.4 | 3.8 | 3.4 | 3.3 | 3.1 | 3.2 | 3.2 | 3.1 | 3.2 | 235 |
| 240 | 4 | 3.6 | 3.5 | 3.9 | 3.5 | 3.4 | 3.8 | 3.4 | 3.3 | 2.9 | 3.1 | 3.2 | 2.9 | 3.1 | 240 |
| 245 | 3.9 | 3.6 | 3.5 | 3.9 | 3.5 | 3.4 | 3.7 | 3.4 | 3.3 | 2.8 | 3 | 3.2 | 2.8 | 3 | 245 |
| 250 | 3.9 | 3.5 | 3.5 | 3.8 | 3.4 | 3.4 | 3.6 | 3.4 | 3.3 | 2.6 | 2.9 | 3.1 | 2.6 | 2.9 | 250 |
| 255 | 3.8 | 3.5 | 3.5 | 3.7 | 3.4 | 3.4 | 3.5 | 3.3 | 3.3 | 2.5 | 2.8 | 3.1 | 2.5 | 2.8 | 255 |
| 260 | 3.8 | 3.5 | 3.5 | 3.7 | 3.4 | 3.4 | 3.5 | 3.3 | 3.3 | 2.3 | 2.7 | 3 | 2.3 | 2.6 | 260 |
| 265 | 3.7 | 3.5 | 3.5 | 3.6 | 3.4 | 3.4 | 3.4 | 3.3 | 3.3 | 2.2 | 2.5 | 2.8 | | 2.5 | 265 |
| 270 | 3.7 | 3.5 | 3.5 | 3.5 | 3.4 | 3.4 | 3.3 | 3.3 | 3.3 | | 2.4 | 2.7 | | 2.4 | 270 |
| 275 | 3.6 | 3.5 | 3.5 | 3.4 | 3.4 | 3.4 | 3.2 | 3.2 | 3.3 | | 2.2 | 2.5 | | 2.2 | 275 |
| 280 | 3.5 | 3.5 | 3.5 | 3.2 | 3.3 | 3.4 | 3 | 3.1 | 3.3 | | | 2.4 | | | 280 |
| 285 | 3.5 | 3.5 | | 2.9 | 3.3 | 3.4 | | 3.1 | 3.3 | | | 2.2 | | | 285 |
| 290 | 3.5 | 3.5 | | 2.8 | 3.2 | 3.4 | | 3 | 3.3 | | | | | | 290 |
| 295 | 3.3 | 3.5 | | 2.6 | 2.8 | 3.2 | | 2.8 | 3.1 | | | | | | 295 |
| 300 | 2.2 | 3.4 | | 2.5 | 2.7 | | | | 2.7 | | | | | | 300 |
| 305 | | 2.6 | | | 2.6 | | | | | | | | | | 305 |
| 310 | | | | | 2.4 | | | | | | | | | | 310 |

t_240_002_50601_00_000 / 52601_00_000 / 54601_00_000

Lifting heights Hauteurs de levage

TK

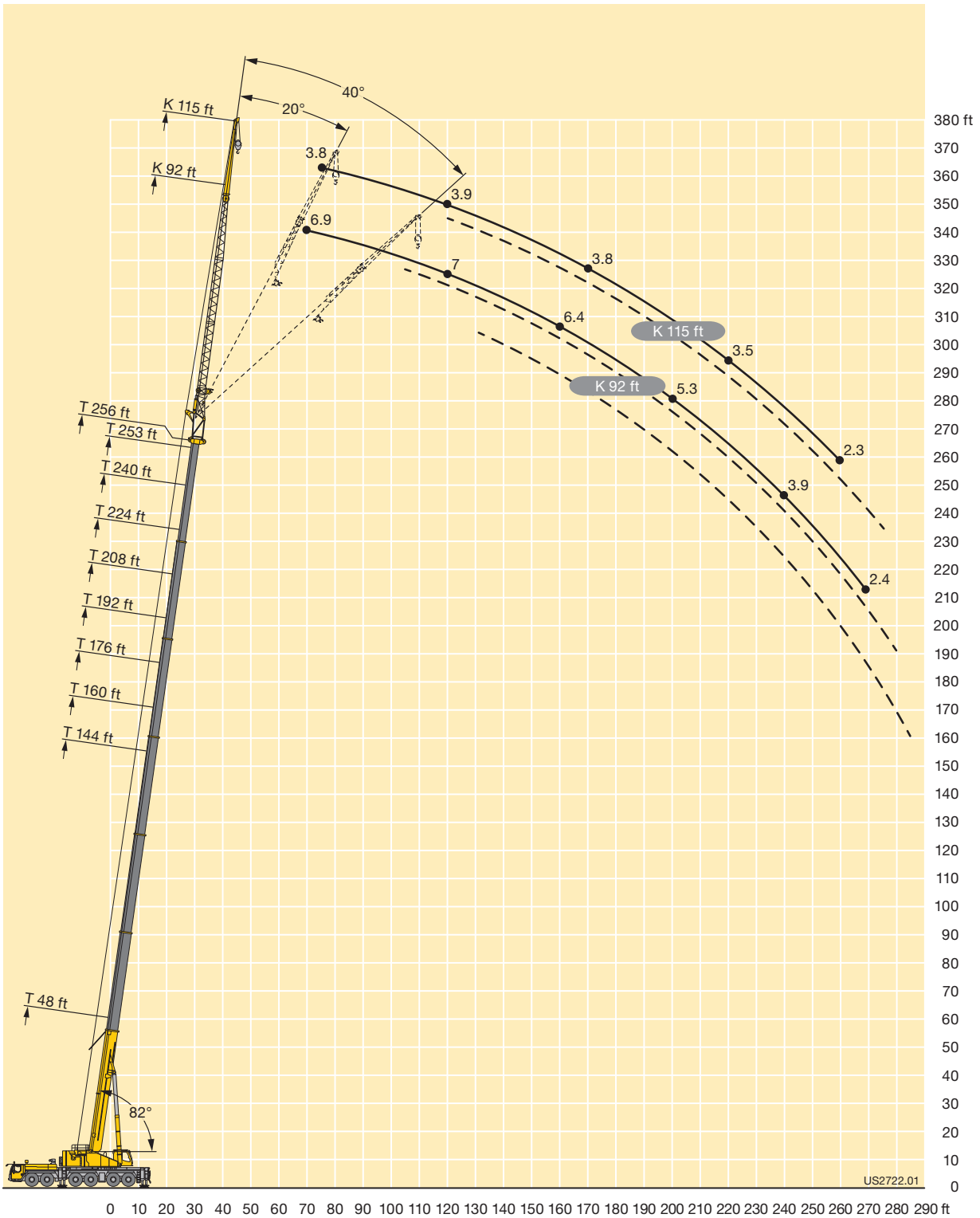

Lifting capacities Forces de levage

TNZK



| ft | 48 ft | | | 64 ft | | | 80 ft | | | 96 ft | | | 112 ft | | | 128 ft | | | 144 ft | | | 160 ft | | | ft |
|-----|-------|-------|------|-------|-------|-------|-------|-------|-------|-------|------|-------|--------|------|-------|--------|------|------|--------|------|------|--------|------|------|-----|
| | 18 ft | | | 18 ft | | | 18 ft | | | 18 ft | | | 18 ft | | | 18 ft | | | 18 ft | | | | | | |
| | 0° | 20° | 40° | 0° | 20° | 40° | 0° | 20° | 40° | 0° | 20° | 40° | 0° | 20° | 40° | 0° | 20° | 40° | 0° | 20° | 40° | 0° | 20° | 40° | |
| 12 | 128.3 | 101.2 | | | | | | | | | | | | | | | | | | | | | | 12 | |
| 13 | 125.9 | 99.2 | 84.3 | 130.9 | 103 | | | | | | | | | | | | | | | | | | | 13 | |
| 14 | 122.7 | 97.2 | 82.9 | 130.3 | 101.1 | 130.4 | | | | | | | | | | | | | | | | | | 14 | |
| 15 | 119.5 | 95.3 | 81.7 | 127.6 | 99.4 | 83.9 | 129.2 | 100.7 | | | | | | | | | | | | | | | | 15 | |
| 16 | 116.3 | 93.5 | 80.5 | 124.9 | 97.8 | 82.8 | 127.4 | 99.6 | 126.8 | | | | | | | | | | | | | | | 16 | |
| 17 | 113.7 | 91.8 | 79.3 | 122.4 | 96.2 | 81.8 | 125.2 | 98.2 | 125.1 | | | | | | | | | | | | | | | 17 | |
| 18 | 111.2 | 90.1 | 78.2 | 120 | 94.7 | 80.8 | 123.1 | 96.8 | 81.8 | 123.4 | 97.5 | 121.2 | | | | | | | | | | | | 18 | |
| 19 | 108.6 | 88.4 | 77.1 | 117.6 | 93.3 | 79.9 | 121 | 95.5 | 81 | 121.7 | 96.4 | 119.9 | | | | | | | | | | | | 19 | |
| 20 | 106 | 86.9 | 76.1 | 115.2 | 91.9 | 78.9 | 119 | 94.2 | 80.2 | 120 | 95.3 | 118.6 | | | | | | | | | | | | 20 | |
| 22 | 101.2 | 84 | 74 | 110.7 | 89.2 | 77.1 | 115.1 | 91.7 | 78.5 | 116.6 | 93 | 79.4 | 115.9 | 93.5 | 105.6 | | | | | | | | | 22 | |
| 24 | 96.9 | 81.1 | 72.2 | 106.7 | 86.4 | 75.3 | 111.2 | 89.2 | 77 | 113.1 | 90.8 | 77.9 | 113.1 | 91.5 | 78.3 | 105.6 | 91.1 | | | | | | | 24 | |
| 26 | 92.9 | 78.6 | 70.4 | 102.6 | 84.1 | 73.6 | 107.5 | 87 | 75.4 | 109.9 | 88.7 | 76.5 | 110.2 | 89.5 | 77 | 105.3 | 89.6 | 95.2 | | | | | | 26 | |
| 28 | 89.1 | 76.1 | 68.8 | 98.8 | 81.8 | 72.2 | 104.2 | 84.8 | 74.1 | 106.9 | 86.7 | 75.2 | 107.5 | 87.6 | 75.8 | 104.7 | 88.2 | 76.8 | 94.7 | 83.6 | | | | 28 | |
| 30 | 86 | 73.8 | 67.3 | 95.4 | 79.5 | 70.8 | 101.1 | 82.8 | 72.7 | 103.9 | 84.8 | 73.9 | 104.8 | 85.8 | 74.6 | 103.9 | 86.9 | 75.8 | 94.2 | 82.7 | 79.4 | | | 30 | |
| 32 | 82.8 | 71.9 | 65.9 | 92.3 | 77.5 | 69.4 | 98 | 81 | 71.4 | 100.9 | 83 | 72.8 | 102.4 | 84.2 | 73.5 | 102.4 | 85.6 | 74.8 | 93.4 | 81.7 | 73 | 79.4 | | 32 | |
| 34 | 79.9 | 70.1 | 64.7 | 89.2 | 75.6 | 68.2 | 95.1 | 79.2 | 70.2 | 98.5 | 81.2 | 71.6 | 100.1 | 82.6 | 72.4 | 100.8 | 84.3 | 73.9 | 92.4 | 80.7 | 72.2 | 79.3 | 73.9 | 34 | |
| 36 | 77.4 | 68.3 | 63.6 | 86.5 | 73.8 | 67 | 92.4 | 77.5 | 69.1 | 96.1 | 79.6 | 70.5 | 97.8 | 81.1 | 71.4 | 99.1 | 83.1 | 73 | 91.5 | 79.8 | 71.4 | 79 | 73.3 | 67.7 | 36 |
| 38 | 74.9 | 66.7 | 62.6 | 84.1 | 72.1 | 65.9 | 89.9 | 75.9 | 68 | 93.7 | 78.2 | 69.5 | 95.6 | 79.7 | 70.5 | 97.4 | 81.8 | 72.2 | 90.4 | 78.8 | 70.7 | 78.6 | 72.7 | 67.2 | 38 |
| 40 | 72.6 | 65.2 | 61.7 | 81.7 | 70.7 | 64.9 | 87.6 | 74.3 | 67 | 91.4 | 76.8 | 68.5 | 93.6 | 78.2 | 69.5 | 95.7 | 80.6 | 71.3 | 89.3 | 77.9 | 69.9 | 78.2 | 72 | 66.6 | 40 |
| 45 | 67.9 | 62.2 | 60.1 | 76.3 | 67.2 | 62.7 | 82.3 | 70.8 | 64.8 | 86.3 | 73.3 | 66.3 | 88.9 | 75.2 | 67.4 | 91.6 | 77.6 | 69.4 | 86.3 | 75.4 | 68.2 | 76.5 | 70.2 | 65.2 | 45 |
| 50 | 64.1 | 59.9 | 59.4 | 71.7 | 64.3 | 60.9 | 77.7 | 67.9 | 62.9 | 81.8 | 70.4 | 64.3 | 84.4 | 72.3 | 65.5 | 88 | 75 | 67.5 | 83.1 | 73.2 | 66.6 | 73.6 | 67.9 | 63.7 | 50 |
| 55 | 60.5 | 58.2 | 9.1 | 68 | 61.9 | 59.7 | 73.7 | 65.2 | 61.2 | 78 | 67.8 | 62.6 | 80.7 | 69.7 | 63.7 | 84.3 | 72.5 | 66 | 78.7 | 71 | 65.1 | 69.8 | 65.1 | 61.7 | 55 |
| 60 | | | | 64.7 | 59.9 | 32.6 | 70.2 | 63 | 59.9 | 74.4 | 65.6 | 61.2 | 77.2 | 67.3 | 62.2 | 81.2 | 70.2 | 64.4 | 73.8 | 69 | 63.8 | 66.1 | 62.3 | 59.3 | 60 |
| 65 | | | | 62.2 | 58.8 | 16 | 67.2 | 61.1 | 58.9 | 71.2 | 63.4 | 59.9 | 74.2 | 65.3 | 60.9 | 78.2 | 68.3 | 63.1 | 69.1 | 66.9 | 62.6 | 62.5 | 59.9 | 57.1 | 65 |
| 70 | | | | 59.3 | 57.5 | 9.5 | 64.5 | 59.6 | 47.6 | 68.4 | 61.7 | 59 | 71.4 | 63.5 | 59.8 | 74.8 | 66.5 | 61.9 | 64.9 | 64.3 | 61 | 59 | 57.5 | 55.1 | 70 |
| 75 | | | | 41.9 | | | 62.3 | 58.4 | 22.2 | 65.9 | 60.1 | 58.1 | 68.9 | 61.7 | 58.8 | 68.5 | 64.9 | 60.9 | 60.9 | 60.6 | 58.8 | 55.6 | 55.1 | 53.1 | 75 |
| 80 | | | | | | | 60.5 | 57.8 | 13.8 | 63.9 | 58.9 | 57.8 | 64.2 | 60.4 | 58 | 62.6 | 63 | 60.1 | 57.1 | 56.9 | 56.4 | 52.7 | 52.5 | 51.1 | 80 |
| 85 | | | | | | | 58.2 | 55.9 | 9.2 | 60.2 | 57.8 | 29 | 59 | 59 | 57.4 | 57.3 | 57.9 | 58 | 53.7 | 53.6 | 53.6 | 49.8 | 49.8 | 49 | 85 |
| 90 | | | | | | | 40.8 | 13.5 | | 55.6 | 55.9 | 18.1 | 54.4 | 54.8 | 55 | 52.7 | 53.3 | 53.5 | 51.4 | 50.4 | 50.5 | 47.2 | 47.2 | 46.9 | 90 |
| 95 | | | | | | | | | | 51.5 | 51.8 | 12.5 | 50.2 | 50.6 | 37.1 | 48.6 | 49.1 | 49.3 | 49.3 | 47.1 | 47.4 | 44.9 | 44.8 | 44.8 | 95 |
| 100 | | | | | | | | | | 47.9 | 44.9 | 9 | 46.6 | 46.9 | 22.6 | 44.9 | 45.3 | 45.5 | 46.2 | 45.1 | 44.3 | 42.6 | 42.6 | 42.6 | 100 |
| 105 | | | | | | | | | | 35.8 | 15.6 | 5.7 | 43.3 | 43.5 | 15.8 | 43.1 | 41.9 | 40.7 | 42.9 | 43.1 | 42.9 | 40.3 | 40.4 | 40.5 | 105 |
| 110 | | | | | | | | | | | | | 40.3 | 40.5 | 11.7 | 41.4 | 40.2 | 27.7 | 39.9 | 40.2 | 40.4 | 38.2 | 38.2 | 38.3 | 110 |
| 115 | | | | | | | | | | | | | 37.6 | 37.7 | 8.9 | 38.9 | 39 | 19.2 | 37.1 | 37.4 | 37.6 | 35.5 | 35.9 | 36.1 | 115 |
| 120 | | | | | | | | | | | | | 31 | 17 | 6.3 | 36.4 | 36.6 | 14.4 | 34.6 | 34.9 | 32.4 | 33 | 33.3 | 33.5 | 120 |
| 125 | | | | | | | | | | | | | | | | 34.1 | 34.3 | 11.2 | 32.3 | 32.5 | 22.8 | 31.3 | 31.4 | 31.5 | 125 |
| 130 | | | | | | | | | | | | | | | | 32 | 32.1 | 8.8 | 30.2 | 30.4 | 17.2 | 29.5 | 29.8 | 29.9 | 130 |
| 135 | | | | | | | | | | | | | | | | 25 | 18.2 | 6.6 | 28.2 | 28.3 | 13.5 | 27.5 | 27.7 | 26.7 | 135 |
| 140 | | | | | | | | | | | | | | | | | | | 26.3 | 26.4 | 10.8 | 25.6 | 25.8 | 20.1 | 140 |
| 145 | | | | | | | | | | | | | | | | | | | 24.6 | 24.7 | 8.7 | 23.8 | 24 | 15.8 | 145 |
| 150 | | | | | | | | | | | | | | | | | | | 20.7 | 19 | 6.9 | 22.2 | 22.4 | 12.7 | 150 |
| 155 | | | | | | | | | | | | | | | | | | | | | | 20.7 | 20.9 | 10.5 | 155 |
| 160 | | | | | | | | | | | | | | | | | | | | | | 19.4 | 19.4 | 8.6 | 160 |
| 165 | | | | | | | | | | | | | | | | | | | | | | 16.4 | 16.4 | 7 | 165 |
| 170 | | | | | | | | | | | | | | | | | | | | | | 10.5 | 9.4 | | 170 |

t_240_002_56001_00_000

Lifting capacities Forces de levage

TNZK



| ft | 176 ft | | | 192 ft | | | 208 ft | | | 224 ft | | | 240 ft | | | 253 ft | | | 256 ft | | | ft |
|-----|--------|------|------|--------|------|------|--------|------|------|--------|------|------|--------|------|------|--------|------|------|--------|------|------|-----|
| | 18 ft | | | 18 ft | | | 18 ft | | | 18 ft | | | 18 ft | | | 18 ft | | | | | | |
| | 0° | 20° | 40° | 0° | 20° | 40° | 0° | 20° | 40° | 0° | 20° | 40° | 0° | 20° | 40° | 0° | 20° | 40° | 0° | 20° | 40° | |
| 34 | 64.7 | | | | | | | | | | | | | | | | | | | | 34 | |
| 36 | 64.5 | | | | | | | | | | | | | | | | | | | | | 36 |
| 38 | 64.2 | 64.7 | | 51.5 | | | | | | | | | | | | | | | | | | 38 |
| 40 | 64 | 64.5 | | 51.3 | | | | | | | | | | | | | | | | | | 40 |
| 45 | 63.2 | 63.7 | 61 | 50.8 | 51.2 | 51.4 | 41.6 | | | | | | | | | | | | | | | 45 |
| 50 | 62.2 | 62.8 | 60 | 50.3 | 50.7 | 51.2 | 41.2 | 41.5 | 42.2 | 34 | | | 25.4 | | | | | | | | | 50 |
| 55 | 60.7 | 60.6 | 58.7 | 49.7 | 50 | 50.5 | 40.9 | 41.2 | 41.3 | 33.8 | 33.8 | 34.1 | 25.3 | 25.4 | | 21 | | | 20.4 | | | 55 |
| 60 | 57.9 | 57.8 | 56.7 | 48.7 | 48.8 | 49 | 40.3 | 40.1 | 40.2 | 33.2 | 33.2 | 33.5 | 25.1 | 25.2 | 25.1 | 21 | 21 | | 20.4 | 20.4 | | 60 |
| 65 | 55 | 54.9 | 54.4 | 46.9 | 47 | 47.2 | 39.1 | 38.9 | 39 | 32.5 | 32.4 | 32.6 | 24.9 | 24.9 | 25 | 20.9 | 20.9 | 20.9 | 20.3 | 20.4 | 20.3 | 65 |
| 70 | 52.2 | 52.2 | 52.1 | 44.9 | 45 | 45.3 | 37.9 | 37.7 | 37.7 | 31.6 | 31.4 | 31.5 | 24.6 | 24.5 | 24.6 | 20.7 | 20.7 | 20.8 | 20.2 | 20.3 | 20.3 | 70 |
| 75 | 49.6 | 49.5 | 49.7 | 43 | 43.1 | 43.3 | 36.6 | 36.4 | 36.3 | 30.6 | 30.3 | 30.4 | 24.1 | 24 | 24.1 | 20.4 | 20.3 | 20.4 | 20 | 20 | 20.1 | 75 |
| 80 | 46.9 | 4 | 47.1 | 41.1 | 41.1 | 41.4 | 35.3 | 35 | 34.9 | 29.5 | 29.3 | 29.3 | 23.5 | 23.4 | 23.5 | 19.9 | 19.9 | 19.9 | 19.6 | 19.6 | 19.6 | 80 |
| 85 | 44.4 | 44.4 | 44.6 | 39.2 | 39.2 | 39.5 | 34 | 33.7 | 33.6 | 28.5 | 28.3 | 28.3 | 22.8 | 22.8 | 22.8 | 19.4 | 19.3 | 19.4 | 19.1 | 19.1 | 19.1 | 85 |
| 90 | 42.1 | 42.1 | 42.3 | 37.3 | 37.4 | 37.6 | 32.7 | 32.4 | 32.3 | 27.5 | 27.3 | 27.3 | 22.2 | 22.1 | 22.2 | 18.8 | 18.7 | 18.8 | 18.6 | 18.5 | 18.5 | 90 |
| 95 | 39.8 | 40 | 40.1 | 35.5 | 35.6 | 35.8 | 31.4 | 31.2 | 31.1 | 26.6 | 26.3 | 26.3 | 21.5 | 21.4 | 21.5 | 18.2 | 18.1 | 18.2 | 18 | 17.9 | 18 | 95 |
| 100 | 37.7 | 37.8 | 38 | 33.8 | 33.9 | 34.1 | 30.1 | 30 | 29.9 | 25.6 | 25.4 | 25.4 | 20.9 | 20.7 | 20.8 | 17.6 | 17.5 | 17.6 | 17.4 | 17.4 | 17.4 | 100 |
| 105 | 35.9 | 35.9 | 36 | 32.1 | 32.2 | 32.5 | 28.9 | 28.8 | 28.8 | 24.7 | 24.5 | 24.5 | 20.2 | 20.1 | 20.1 | 17 | 16.9 | 17 | 16.8 | 16.8 | 16.8 | 105 |
| 110 | 34 | 34.2 | 34.3 | 30.6 | 30.6 | 30.9 | 27.6 | 27.6 | 27.6 | 23.7 | 23.6 | 23.6 | 19.5 | 19.4 | 19.5 | 16.5 | 16.4 | 16.4 | 16.3 | 16.2 | 16.3 | 110 |
| 115 | 32.2 | 32.4 | 32.5 | 29.1 | 29.2 | 29.4 | 26.3 | 26.4 | 26.5 | 22.9 | 22.7 | 22.7 | 18.9 | 18.8 | 18.8 | 15.9 | 15.8 | 15.9 | 15.8 | 15.7 | 15.7 | 115 |
| 120 | 30.6 | 30.7 | 30.8 | 27.7 | 27.8 | 28 | 25.1 | 25.2 | 25.3 | 22.1 | 21.9 | 21.9 | 18.2 | 18.1 | 18.2 | 15.4 | 15.3 | 15.4 | 15.3 | 15.2 | 15.2 | 120 |
| 125 | 29.1 | 29.2 | 29.3 | 26.3 | 26.5 | 26.6 | 24 | 24 | 24.2 | 21.3 | 21.2 | 21.2 | 17.6 | 17.5 | 17.6 | 14.8 | 14.8 | 14.8 | 14.7 | 14.7 | 14.7 | 125 |
| 130 | 27.7 | 27.7 | 27.9 | 25 | 25.2 | 25.3 | 22.9 | 23 | 23.1 | 20.5 | 20.4 | 20.4 | 17.1 | 17 | 17 | 14.3 | 14.3 | 14.3 | 14.3 | 14.2 | 14.2 | 130 |
| 135 | 25.8 | 26.1 | 26.3 | 23.8 | 23.9 | 24 | 21.8 | 22 | 22.1 | 19.7 | 19.6 | 19.7 | 16.5 | 16.4 | 16.5 | 13.8 | 13.8 | 13.8 | 13.8 | 13.7 | 13.8 | 135 |
| 140 | 23.9 | 24.2 | 24.4 | 22.7 | 22.8 | 22.9 | 20.8 | 20.9 | 21 | 19 | 18.9 | 19 | 15.9 | 15.9 | 15.9 | 13.4 | 13.4 | 13.4 | 13.3 | 13.3 | 13.3 | 140 |
| 145 | 22.9 | 22.9 | 23 | 21.5 | 21.7 | 21.8 | 19.8 | 19.9 | 20 | 18.2 | 18.2 | 18.3 | 15.4 | 15.4 | 15.4 | 12.9 | 12.9 | 12.9 | 12.9 | 12.8 | 12.9 | 145 |
| 150 | 21.9 | 21.9 | 22 | 20.5 | 20.6 | 20.7 | 18.9 | 19 | 19.1 | 17.5 | 17.5 | 17.6 | 15 | 14.9 | 14.9 | 12.5 | 12.5 | 12.5 | 12.4 | 12.4 | 12.4 | 150 |
| 155 | 20.6 | 20.8 | 18.2 | 19.2 | 19.5 | 19.6 | 17.9 | 18.1 | 18.2 | 16.7 | 16.8 | 16.9 | 14.5 | 14.4 | 14.5 | 12.1 | 12.1 | 12.1 | 12 | 12 | 12 | 155 |
| 160 | 19.2 | 19.3 | 14.7 | 17.8 | 18.1 | 18.1 | 17.1 | 17.2 | 17.3 | 16 | 16.1 | 16.2 | 14 | 14 | 14 | 11.7 | 11.7 | 11.7 | 11.7 | 11.6 | 11.7 | 160 |
| 165 | 17.8 | 18 | 12.2 | 17 | 17.1 | 17.1 | 16.2 | 16.3 | 16.4 | 15.3 | 15.4 | 15.4 | 13.6 | 13.5 | 13.6 | 11.3 | 11.3 | 11.3 | 11.3 | 11.3 | 11.3 | 165 |
| 170 | 16.6 | 16.7 | 10.2 | 16.3 | 16.3 | 16.4 | 15.4 | 15.6 | 15.6 | 14.6 | 14.6 | 14.7 | 13.1 | 13.1 | 13.1 | 10.9 | 10.9 | 11 | 10.9 | 10.9 | 10.9 | 170 |
| 175 | 15.5 | 15.6 | 8.6 | 15.7 | 15.7 | 13.9 | 14.5 | 14.7 | 14.7 | 13.8 | 13.9 | 14 | 12.7 | 12.7 | 12.7 | 10.6 | 10.6 | 10.6 | 10.6 | 10.6 | 10.6 | 175 |
| 180 | 13.1 | 13.2 | 7.1 | 14.8 | 14.9 | 11.8 | 13.5 | 13.5 | 13.6 | 13.2 | 13.3 | 13.3 | 12.3 | 12.3 | 12.3 | 10.2 | 10.2 | 10.2 | 10.2 | 10.2 | 10.2 | 180 |
| 185 | 9.3 | 9.1 | | 13.8 | 13.9 | 10 | 12.9 | 12.9 | 13 | 12.6 | 12.7 | 12.7 | 11.9 | 11.9 | 11.9 | 9.8 | 9.8 | 9.9 | 9.7 | 9.8 | 9.8 | 185 |
| 190 | | | | 12.8 | 12.9 | 8.6 | 12.4 | 12.5 | 12.5 | 11.4 | 11.4 | 11.5 | 11.5 | 11.5 | 11.6 | 9.5 | 9.5 | 9.5 | 9.2 | 9.3 | 9.3 | 190 |
| 195 | | | | 10.7 | 10.7 | 7.2 | 11.9 | 12 | 11.4 | 10.9 | 11 | 11 | 11 | 11 | 11.1 | 9.1 | 9.1 | 9.2 | 8.8 | 8.8 | 8.9 | 195 |
| 200 | | | | 7.7 | 7.7 | 5.1 | 11.4 | 11.4 | 9.9 | 9.4 | 9.7 | 9.8 | 10.5 | 10.6 | 10.6 | 8.8 | 8.8 | 8.9 | 8.3 | 8.4 | 8.4 | 200 |
| 205 | | | | | | | 9.8 | 9.9 | 8.5 | 7.5 | 7.9 | 7.8 | 10 | 10.1 | 10.1 | 8.5 | 8.5 | 8.5 | 7.9 | 7.9 | 8 | 205 |
| 210 | | | | | | | 8.8 | 8.8 | 7.3 | 5.7 | 6 | 6 | 9.5 | 9.6 | 9.6 | 8.1 | 8.2 | 8.2 | 7.5 | 7.5 | 7.5 | 210 |
| 215 | | | | | | | 5.7 | 5.8 | 4.2 | 4 | 4.3 | 4.2 | 8.8 | 8.9 | 8.9 | 7.8 | 7.9 | 7.9 | 7.1 | 7.1 | 7.1 | 215 |
| 220 | | | | | | | | | | 2.4 | 2.6 | 2.3 | 8.1 | 8.2 | 8.2 | 7.5 | 7.6 | 7.6 | 6.7 | 6.7 | 6.7 | 220 |
| 225 | | | | | | | | | | | | | 7.4 | 7.5 | 7.5 | 7.2 | 7.2 | 7.3 | 6.3 | 6.3 | 6.3 | 225 |
| 230 | | | | | | | | | | | | | 6.9 | 6.9 | 6.9 | 6.9 | 7 | 7 | 5.9 | 5.9 | 6 | 230 |
| 235 | | | | | | | | | | | | | 6.4 | 6.4 | 6.4 | 6.5 | 6.5 | 6.5 | 5.6 | 5.6 | 5.6 | 235 |
| 240 | | | | | | | | | | | | | 4.6 | 4.8 | 4.3 | 5.9 | 6 | 6 | 5.2 | 5.2 | 5.2 | 240 |
| 245 | | | | | | | | | | | | | | | | 5.3 | 5.3 | 5.3 | 4.9 | 4.8 | 4.8 | 245 |
| 250 | | | | | | | | | | | | | | | | 4.4 | 4.6 | 4.3 | 4.4 | 4.4 | 4.4 | 250 |
| 255 | | | | | | | | | | | | | | | | | 2.1 | | 2.8 | 3 | 2.6 | 255 |

t_240_002_56001_00_000

Lifting capacities Forces de levage

TNZK

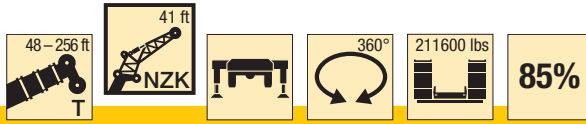

| ft | 48 ft | | | 144 ft | | | 160 ft | | | 176 ft | | | 192 ft | | | ft |
|-----|-------|------|------|--------|------|------|--------|------|------|--------|------|------|--------|------|------|-----|
| | 41 ft | | | 41 ft | | | 41 ft | | | 41 ft | | | 41 ft | | | |
| | 0° | 20° | 40° | 0° | 20° | 40° | 0° | 20° | 40° | 0° | 20° | 40° | 0° | 20° | 40° | |
| 12 | 52.4 | | | | | | | | | | | | | | | 12 |
| 13 | 52.1 | | | | | | | | | | | | | | | 13 |
| 14 | 51.7 | | | | | | | | | | | | | | | 14 |
| 15 | 51.2 | | | | | | | | | | | | | | | 15 |
| 16 | 50.7 | | | | | | | | | | | | | | | 16 |
| 17 | 50.1 | | | | | | | | | | | | | | | 17 |
| 18 | 49.5 | | | | | | | | | | | | | | | 18 |
| 19 | 48.9 | 39.2 | | | | | | | | | | | | | | 19 |
| 20 | 48.3 | 39 | | | | | | | | | | | | | | 20 |
| 22 | 47.1 | 37.2 | | | | | | | | | | | | | | 22 |
| 24 | 45.8 | 35.3 | | 52.7 | | | | | | | | | | | | 24 |
| 26 | 44.3 | 33.6 | | 52.8 | | | | | | | | | | | | 26 |
| 28 | 42.9 | 32.1 | 23.1 | 52.8 | | | 47.4 | | | | | | | | | 28 |
| 30 | 41.4 | 30.8 | 22.8 | 52.6 | | | 47.4 | | | | | | | | | 30 |
| 32 | 40.1 | 29.5 | 22.1 | 52.4 | | | 47.4 | | | 41.7 | | | | | | 32 |
| 34 | 38.8 | 28.5 | 21.6 | 52 | | | 47.3 | | | 41.6 | | | | | | 34 |
| 36 | 37.5 | 27.4 | 21.1 | 51.6 | | | 47.1 | | | 41.6 | | | 35.6 | | | 36 |
| 38 | 36.3 | 26.4 | 20.6 | 51.2 | 38.4 | | 46.7 | | | 41.5 | | | 35.7 | | | 38 |
| 40 | 34.9 | 25.6 | 20.2 | 50.7 | 37.5 | | 46.3 | | | 41.3 | | | 35.7 | | | 40 |
| 45 | 31.2 | 23.6 | 19.2 | 49.3 | 35.2 | 23.1 | 45.4 | 36.1 | | 40.7 | | | 35.5 | | | 45 |
| 50 | 28 | 22.1 | 18.4 | 47.8 | 33.3 | 22.3 | 44.5 | 34.1 | 22.5 | 40.1 | 34.5 | | 35.2 | | | 50 |
| 55 | 25.4 | 20.8 | 17.8 | 46.3 | 31.6 | 21.7 | 43.5 | 32.3 | 21.9 | 39.5 | 32.9 | 22 | 34.8 | 31.8 | | 55 |
| 60 | 23.4 | 19.6 | 17.4 | 44.6 | 30 | 21.1 | 42.6 | 30.8 | 21.3 | 38.8 | 31.3 | 21.4 | 34.4 | 31 | 21.5 | 60 |
| 65 | 21.6 | 18.7 | 17.1 | 42.8 | 28.7 | 20.6 | 41.4 | 29.5 | 20.8 | 38.2 | 29.9 | 20.9 | 34 | 30.1 | 20.9 | 65 |
| 70 | 20.1 | 18 | 17.1 | 41.1 | 27.5 | 20.1 | 40.1 | 28.3 | 20.3 | 37.5 | 28.7 | 20.5 | 33.6 | 28.8 | 20.5 | 70 |
| 75 | 18.8 | 17.6 | 16.3 | 39.5 | 26.4 | 19.6 | 38.8 | 27.2 | 19.9 | 36.7 | 27.5 | 20 | 33.1 | 27.7 | 20.1 | 75 |
| 80 | 17.8 | 17.5 | | 38 | 25.4 | 19.2 | 37.6 | 26.2 | 19.5 | 35.8 | 26.6 | 19.7 | 32.7 | 26.7 | 19.7 | 80 |
| 85 | | | | 36.5 | 24.5 | 18.9 | 36.4 | 25.2 | 19.1 | 34.9 | 25.7 | 19.3 | 32 | 25.8 | 19.4 | 85 |
| 90 | | | | 34.8 | 23.6 | 18.6 | 35.2 | 24.4 | 18.8 | 34 | 24.8 | 19 | 31.4 | 25 | 19.1 | 90 |
| 95 | | | | 33 | 22.9 | 18.3 | 34.1 | 23.6 | 18.5 | 33.1 | 24 | 18.7 | 30.7 | 24.3 | 18.8 | 95 |
| 100 | | | | 31.3 | 22.2 | 18 | 32.9 | 22.9 | 18.2 | 32.3 | 23.3 | 18.4 | 29.9 | 23.5 | 18.5 | 100 |
| 105 | | | | 29.6 | 21.5 | 17.8 | 31.4 | 22.3 | 18 | 31.5 | 22.7 | 18.1 | 29 | 22.9 | 18.2 | 105 |
| 110 | | | | 28.2 | 20.9 | 17.6 | 30 | 21.6 | 17.8 | 30.5 | 22.1 | 17.9 | 27.8 | 22.3 | 18 | 110 |
| 115 | | | | 26.9 | 20.4 | 17.4 | 28.6 | 21 | 17.6 | 29.4 | 21.5 | 17.7 | 26.5 | 21.7 | 17.8 | 115 |
| 120 | | | | 25.7 | 19.9 | 17.3 | 27.3 | 20.6 | 17.4 | 28.2 | 21 | 17.5 | 25.4 | 21.1 | 17.6 | 120 |
| 125 | | | | 24.6 | 19.4 | 17.2 | 26.3 | 20.1 | 17.3 | 27 | 20.5 | 17.4 | 24.3 | 20.7 | 17.4 | 125 |
| 130 | | | | 23.7 | 19 | 17.1 | 25.2 | 19.6 | 17.1 | 25.9 | 20.1 | 17.2 | 23.2 | 20.3 | 17.3 | 130 |
| 135 | | | | 22.8 | 18.6 | 17.1 | 24.2 | 19.2 | 17.1 | 24.7 | 19.7 | 17.2 | 22.2 | 19.9 | 17.2 | 135 |
| 140 | | | | 21.9 | 18.3 | 17.1 | 23.3 | 18.9 | 17 | 23.6 | 19.3 | 17.1 | 21.2 | 19.5 | 17.1 | 140 |
| 145 | | | | 21.1 | 18 | 15.7 | 22.6 | 18.6 | 17 | 22.6 | 18.9 | 17 | 20.2 | 19.1 | 17.1 | 145 |
| 150 | | | | 20.4 | 17.8 | 10.1 | 21.8 | 18.2 | 17 | 21.5 | 18.6 | 17 | 19.3 | 18.7 | 17 | 150 |
| 155 | | | | 19.7 | 17.6 | 7.2 | 21 | 18 | 16.5 | 20.4 | 18.4 | 17 | 18.4 | 18.3 | 17 | 155 |
| 160 | | | | 19.1 | 17.5 | 5.4 | 20.4 | 17.8 | 12.4 | 19 | 18.1 | 17 | 17.5 | 17.8 | 16.8 | 160 |
| 165 | | | | 18.6 | 17.5 | | 19.4 | 17.6 | 8.7 | 17.7 | 17.8 | 17 | 16.7 | 17.1 | 16.6 | 165 |
| 170 | | | | 17.2 | 16 | | 18.1 | 17.5 | 6.6 | 17 | 17.1 | 15.1 | 16 | 16.4 | 16.4 | 170 |
| 175 | | | | 10.2 | 6.9 | | 17 | 17.4 | 5.1 | 16.3 | 16.5 | 10.5 | 15 | 15.6 | 15.8 | 175 |
| 180 | | | | | | | 15.9 | 16.3 | | 15.5 | 15.8 | 7.8 | 14 | 14.7 | 15 | 180 |
| 185 | | | | | | | 13.3 | 15.2 | | 14.5 | 15 | 6.1 | 13.1 | 13.6 | 12.2 | 185 |
| 190 | | | | | | | 7.7 | 7.5 | | 13.6 | 14 | 4.9 | 12.6 | 12.7 | 9.1 | 190 |
| 195 | | | | | | | | | | 12.7 | 13 | | 12.1 | 12.2 | 7.2 | 195 |
| 200 | | | | | | | | | | 10.4 | 12.1 | | 11.6 | 11.7 | 5.8 | 200 |
| 205 | | | | | | | | | | 6.1 | 7.8 | | 11 | 11.3 | | 205 |
| 210 | | | | | | | | | | | | | 10.3 | 10.6 | | 210 |
| 215 | | | | | | | | | | | | | 8.3 | 9.8 | | 215 |
| 220 | | | | | | | | | | | | | 7.1 | 7.2 | | 220 |

t_240_002_56101_00_000

Lifting capacities Forces de levage

TNZK

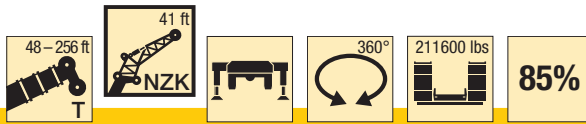

| ft | 208 ft | | | 224 ft | | | 240 ft | | | 253 ft | | | 256 ft | | | ft |
|-----|--------|------|------|--------|------|------|--------|------|------|--------|------|------|--------|------|------|-----|
| | 41 ft | | | 41 ft | | | 41 ft | | | 41 ft | | | 41 ft | | | |
| | 0° | 20° | 40° | 0° | 20° | 40° | 0° | 20° | 40° | 0° | 20° | 40° | 0° | 20° | 40° | |
| 45 | 30 | | | 23.3 | | | | | | | | | | | | 45 |
| 50 | 30.1 | | | 23.5 | | | 19.4 | | | | | | | | | 50 |
| 55 | 29.9 | | | 23.6 | | | 19.4 | | | 16.4 | | | 15.9 | | | 55 |
| 60 | 29.7 | 28.3 | | 23.8 | | | 19.4 | | | 16.4 | | | 15.9 | | | 60 |
| 65 | 29.5 | 27.8 | 20.9 | 23.9 | 23.9 | | 19.3 | | | 16.4 | | | 16 | | | 65 |
| 70 | 29.3 | 27.3 | 22.6 | 23.8 | 23.7 | | 19.2 | 19.2 | | 16.3 | | | 15.9 | | | 70 |
| 75 | 28.9 | 26.9 | 22 | 23.6 | 23.3 | 22.5 | 19.1 | 18.8 | | 16.1 | 16 | | 15.8 | 15.7 | | 75 |
| 80 | 28.5 | 26.4 | 21.5 | 23.2 | 22.8 | 22.1 | 18.9 | 18.4 | 17.8 | 15.9 | 15.8 | | 15.6 | 15.5 | | 80 |
| 85 | 28.1 | 25.6 | 21.1 | 22.6 | 22.3 | 21.6 | 18.7 | 17.9 | 17.4 | 15.7 | 15.5 | 15.1 | 15.4 | 15.2 | 15 | 85 |
| 90 | 27.4 | 24.8 | 20.8 | 22.1 | 21.7 | 21.2 | 18.2 | 17.5 | 16.9 | 15.5 | 15.1 | 14.7 | 15.2 | 15 | 14.6 | 90 |
| 95 | 26.7 | 24.1 | 20.5 | 21.5 | 21.1 | 20.7 | 17.9 | 17 | 16.4 | 15.1 | 14.8 | 14.4 | 14.9 | 14.6 | 14.2 | 95 |
| 100 | 25.8 | 23.4 | 20.2 | 20.8 | 20.4 | 20.3 | 17.4 | 16.6 | 16 | 14.7 | 14.4 | 14 | 14.5 | 14.3 | 13.9 | 100 |
| 105 | 24.9 | 22.8 | 19.9 | 20.2 | 19.8 | 19.7 | 17 | 16.1 | 15.6 | 14.3 | 14.1 | 13.7 | 14.1 | 13.9 | 13.6 | 105 |
| 110 | 24 | 22.2 | 19.4 | 19.5 | 19.1 | 19.1 | 16.5 | 15.7 | 15.2 | 13.9 | 13.7 | 13.4 | 13.8 | 13.6 | 13.3 | 110 |
| 115 | 23.2 | 21.7 | 18.8 | 18.9 | 18.5 | 18.5 | 16.1 | 15.3 | 14.9 | 13.5 | 13.3 | 13 | 13.4 | 13.2 | 12.9 | 115 |
| 120 | 22.4 | 21.1 | 18.2 | 18.2 | 17.9 | 17.9 | 15.6 | 14.9 | 14.5 | 13.1 | 12.9 | 12.7 | 12.9 | 12.8 | 12.6 | 120 |
| 125 | 21.5 | 20.7 | 17.6 | 17.6 | 17.3 | 17.3 | 15.1 | 14.6 | 14.2 | 12.6 | 12.5 | 12.4 | 12.5 | 12.4 | 12.3 | 125 |
| 130 | 20.7 | 20.1 | 17.3 | 17 | 16.8 | 16.7 | 14.6 | 14.2 | 13.9 | 12.2 | 12.1 | 12.1 | 12.1 | 12 | 12.1 | 130 |
| 135 | 19.9 | 19.6 | 17.2 | 16.4 | 16.2 | 16.2 | 14.1 | 13.8 | 13.5 | 11.8 | 11.7 | 11.8 | 11.7 | 11.6 | 11.7 | 135 |
| 140 | 19.1 | 19 | 17.1 | 15.9 | 15.7 | 15.7 | 13.7 | 13.4 | 13.2 | 11.4 | 11.3 | 11.4 | 11.3 | 11.2 | 11.4 | 140 |
| 145 | 18.3 | 18.3 | 17.1 | 15.4 | 15.2 | 15.2 | 13.2 | 13 | 12.9 | 11 | 10.9 | 11 | 10.9 | 10.9 | 11 | 145 |
| 150 | 17.5 | 17.7 | 17 | 14.9 | 14.7 | 14.7 | 12.8 | 12.7 | 12.6 | 10.6 | 10.6 | 10.7 | 10.6 | 10.5 | 10.6 | 150 |
| 155 | 16.7 | 17.1 | 16.8 | 14.4 | 14.3 | 14.3 | 12.4 | 12.3 | 12.3 | 10.3 | 10.2 | 10.3 | 10.2 | 10.2 | 10.3 | 155 |
| 160 | 16 | 16.4 | 16.3 | 13.9 | 13.8 | 13.8 | 12 | 11.9 | 12 | 9.9 | 9.9 | 10 | 9.8 | 9.8 | 9.9 | 160 |
| 165 | 15.3 | 15.6 | 15.7 | 13.5 | 13.3 | 13.4 | 11.6 | 11.6 | 11.6 | 9.6 | 9.5 | 9.6 | 9.5 | 9.5 | 9.6 | 165 |
| 170 | 14.6 | 14.9 | 15.2 | 13 | 12.9 | 13 | 11.2 | 11.2 | 11.3 | 9.2 | 9.2 | 9.3 | 9.2 | 9.2 | 9.3 | 170 |
| 175 | 13.9 | 14.2 | 14.5 | 12.5 | 12.5 | 12.6 | 10.9 | 10.8 | 10.9 | 8.9 | 8.9 | 9 | 8.9 | 8.9 | 9 | 175 |
| 180 | 13.2 | 13.6 | 13.9 | 12.1 | 12.1 | 12.2 | 10.5 | 10.5 | 10.6 | 8.6 | 8.6 | 8.7 | 8.6 | 8.6 | 8.7 | 180 |
| 185 | 12.6 | 13 | 13.2 | 11.6 | 11.7 | 11.8 | 10.2 | 10.2 | 10.3 | 8.3 | 8.3 | 8.4 | 8.3 | 8.3 | 8.4 | 185 |
| 190 | 12 | 12.3 | 12.6 | 11.1 | 11.3 | 11.5 | 9.8 | 9.8 | 9.9 | 8 | 8 | 8.1 | 8 | 8 | 8.1 | 190 |
| 195 | 11.2 | 11.7 | 11.9 | 10.7 | 10.9 | 11.1 | 9.5 | 9.5 | 9.6 | 7.8 | 7.8 | 7.9 | 7.7 | 7.8 | 7.9 | 195 |
| 200 | 10.3 | 11 | 10.7 | 10.2 | 10.4 | 10.7 | 9.2 | 9.2 | 9.3 | 7.5 | 7.5 | 7.6 | 7.4 | 7.5 | 7.6 | 200 |
| 205 | 9.8 | 10.1 | 8.3 | 9.7 | 10 | 10.2 | 8.9 | 8.9 | 9 | 7.3 | 7.3 | 7.4 | 7.1 | 7.3 | 7.4 | 205 |
| 210 | 9.5 | 9.5 | 6.7 | 9.2 | 9.5 | 9.7 | 8.6 | 8.7 | 8.8 | 7.1 | 7 | 7.1 | 6.8 | 7.1 | 7.1 | 210 |
| 215 | 9.1 | 9.2 | 5.5 | 8.7 | 9 | 9.2 | 8.3 | 8.4 | 8.5 | 6.8 | 6.8 | 6.9 | 6.5 | 6.8 | 6.8 | 215 |
| 220 | 8.7 | 8.8 | | 7.9 | 8.4 | 7.6 | 7.9 | 8.1 | 8.2 | 6.6 | 6.6 | 6.7 | 6.2 | 6.4 | 6.5 | 220 |
| 225 | 8.4 | 8.5 | | 7.6 | 7.7 | 6.3 | 7.6 | 7.8 | 7.9 | 6.4 | 6.4 | 6.5 | 5.9 | 6.1 | 6.2 | 225 |
| 230 | 7 | 8.2 | | 7.4 | 7.4 | 5.3 | 7.2 | 7.5 | 7.6 | 6.2 | 6.2 | 6.3 | 5.5 | 5.7 | 5.9 | 230 |
| 235 | 5.6 | 6.6 | | 7.1 | 7.2 | | 6.8 | 7.1 | 7 | 6 | 6 | 6.1 | 5.1 | 5.4 | 5.5 | 235 |
| 240 | | | | 6.9 | 6.9 | | 6.3 | 6.6 | 6 | 5.8 | 5.8 | 5.9 | 4.8 | 5 | 5.1 | 240 |
| 245 | | | | 6.1 | 6.8 | | 5.8 | 6.1 | 5.1 | 5.5 | 5.6 | 5.7 | 4.4 | 4.7 | 4.7 | 245 |
| 250 | | | | 3.5 | 4.8 | | 5.1 | 5.5 | | 5.2 | 5.4 | 5.5 | 4.1 | 4.3 | 4.4 | 250 |
| 255 | | | | | | | 4.6 | 4.9 | | 4.6 | 5 | 5.1 | 3.8 | 4 | 4 | 255 |
| 260 | | | | | | | 3.2 | 4.3 | | 4 | 4.4 | | 3.5 | 3.7 | 3.7 | 260 |
| 265 | | | | | | | | | | 3.4 | 3.8 | | 3.2 | 3.4 | | 265 |
| 270 | | | | | | | | | | 2.8 | 3.2 | | 2.7 | 3 | | 270 |
| 275 | | | | | | | | | | | | | | 2.4 | | 275 |

t_240_002_56101_00_000

Lifting capacities Forces de levage

TNZK



| ft | 48 ft | | | 144 ft | | | 160 ft | | | 176 ft | | | 192 ft | | | ft |
|-----|-------|------|------|--------|------|------|--------|------|------|--------|------|------|--------|------|------|-----|
| | 69 ft | | | 69 ft | | | 69 ft | | | 69 ft | | | 69 ft | | | |
| | 0° | 20° | 40° | 0° | 20° | 40° | 0° | 20° | 40° | 0° | 20° | 40° | 0° | 20° | 40° | |
| 12 | 20.8 | | | | | | | | | | | | | | | 12 |
| 13 | 20.8 | | | | | | | | | | | | | | | 13 |
| 14 | 20.9 | | | | | | | | | | | | | | | 14 |
| 15 | 21 | | | | | | | | | | | | | | | 15 |
| 16 | 21 | | | | | | | | | | | | | | | 16 |
| 17 | 21 | | | | | | | | | | | | | | | 17 |
| 18 | 21 | | | | | | | | | | | | | | | 18 |
| 19 | 21 | | | | | | | | | | | | | | | 19 |
| 20 | 21 | | | | | | | | | | | | | | | 20 |
| 22 | 21 | | | | | | | | | | | | | | | 22 |
| 24 | 20.9 | | | | | | | | | | | | | | | 24 |
| 26 | 20.7 | | | | | | | | | | | | | | | 26 |
| 28 | 20.5 | | | 20.8 | | | | | | | | | | | | 28 |
| 30 | 20.3 | | | 20.9 | | | 19.9 | | | | | | | | | 30 |
| 32 | 20 | | | 21 | | | 19.9 | | | | | | | | | 32 |
| 34 | 19.7 | 17.8 | | 21 | | | 19.9 | | | 18.7 | | | | | | 34 |
| 36 | 19.4 | 17.5 | | 21 | | | 19.9 | | | 18.7 | | | | | | 36 |
| 38 | 19.1 | 17.2 | | 21 | | | 19.9 | | | 18.8 | | 17.4 | | | | 38 |
| 40 | 18.7 | 16.9 | | 21 | | | 19.9 | | | 18.8 | | 17.4 | | | | 40 |
| 45 | 17.9 | 16.1 | | 21 | | | 19.9 | | | 18.8 | | 17.5 | | | | 45 |
| 50 | 17.1 | 15.4 | | 20.8 | | | 19.9 | | | 18.8 | | 17.5 | | | | 50 |
| 55 | 16.3 | 14.7 | 13.2 | 20.5 | 17.5 | | 19.8 | 17.2 | | 18.8 | | 17.5 | | | | 55 |
| 60 | 15.5 | 14.1 | 12.8 | 20.3 | 17 | | 19.6 | 16.8 | | 18.7 | 16.3 | 17.5 | | | | 60 |
| 65 | 14.8 | 13.6 | 12.4 | 19.9 | 16.7 | | 19.3 | 16.4 | | 18.5 | 16 | 17.3 | 15.2 | | | 65 |
| 70 | 14.2 | 13.1 | 12 | 19.5 | 16.2 | 13.4 | 19 | 16 | | 18.2 | 15.6 | 17.1 | 15 | | | 70 |
| 75 | 13.6 | 12.6 | 11.8 | 19 | 15.8 | 13.2 | 18.6 | 15.6 | 13.1 | 17.9 | 15.3 | 16.8 | 14.7 | | | 75 |
| 80 | 13.1 | 12.3 | 11.6 | 18.6 | 15.4 | 13 | 18.2 | 15.3 | 12.9 | 17.6 | 15 | 12.7 | 16.6 | 14.4 | | 80 |
| 85 | 12.6 | 12 | 11.4 | 18.1 | 15.1 | 12.8 | 17.8 | 15 | 12.7 | 17.2 | 14.7 | 12.5 | 16.3 | 14.2 | 12.2 | 85 |
| 90 | 12.1 | 11.7 | 11.4 | 17.7 | 14.7 | 12.6 | 17.4 | 14.6 | 12.5 | 16.9 | 14.4 | 12.3 | 16 | 13.9 | 12.1 | 90 |
| 95 | 11.6 | 11.5 | 11.4 | 17.2 | 14.4 | 12.4 | 17 | 14.3 | 12.3 | 16.5 | 14.1 | 12.2 | 15.7 | 13.7 | 11.9 | 95 |
| 100 | 11.1 | 11.4 | 11.4 | 16.7 | 14.1 | 12.2 | 16.6 | 14.1 | 12.2 | 16.2 | 13.9 | 12 | 15.4 | 13.4 | 11.8 | 100 |
| 105 | 10.6 | 11.3 | 4.5 | 16.3 | 13.8 | 12.1 | 16.2 | 13.8 | 12 | 15.8 | 13.6 | 11.9 | 15.1 | 13.2 | 11.7 | 105 |
| 110 | 9.8 | | | 15.9 | 13.5 | 11.9 | 15.8 | 13.5 | 11.9 | 15.5 | 13.4 | 11.7 | 14.9 | 13 | 11.5 | 110 |
| 115 | | | | 15.5 | 13.3 | 11.8 | 15.5 | 13.3 | 11.8 | 15.2 | 13.1 | 11.6 | 14.6 | 12.8 | 11.4 | 115 |
| 120 | | | | 15.1 | 13.1 | 11.7 | 15.1 | 13 | 11.6 | 14.9 | 12.9 | 11.5 | 14.4 | 12.6 | 11.3 | 120 |
| 125 | | | | 14.7 | 12.8 | 11.6 | 14.8 | 12.8 | 11.5 | 14.6 | 12.7 | 11.4 | 14.1 | 12.4 | 11.2 | 125 |
| 130 | | | | 14.4 | 12.6 | 11.5 | 14.4 | 12.6 | 11.4 | 14.3 | 12.5 | 11.4 | 13.9 | 12.3 | 11.1 | 130 |
| 135 | | | | 14.1 | 12.4 | 11.4 | 14.1 | 12.4 | 11.4 | 14 | 12.3 | 11.3 | 13.6 | 12.1 | 11.1 | 135 |
| 140 | | | | 13.7 | 12.2 | 11.4 | 13.8 | 12.3 | 11.3 | 13.8 | 12.2 | 11.2 | 13.4 | 11.9 | 11 | 140 |
| 145 | | | | 13.4 | 12.1 | 11.4 | 13.6 | 12.1 | 11.3 | 13.5 | 12 | 11.2 | 13.2 | 11.8 | 11 | 145 |
| 150 | | | | 13.1 | 11.9 | 11.4 | 13.3 | 11.9 | 11.2 | 13.2 | 11.9 | 11.1 | 13 | 11.7 | 10.9 | 150 |
| 155 | | | | 12.9 | 11.8 | 11.4 | 13 | 11.8 | 11.2 | 13 | 11.7 | 11.1 | 12.8 | 11.5 | 10.9 | 155 |
| 160 | | | | 12.6 | 11.7 | 11.4 | 12.8 | 11.7 | 11.2 | 12.8 | 11.6 | 11.1 | 12.6 | 11.4 | 10.8 | 160 |
| 165 | | | | 12.3 | 11.6 | 11.4 | 12.5 | 11.6 | 11.2 | 12.5 | 11.5 | 11.1 | 12.4 | 11.3 | 10.8 | 165 |
| 170 | | | | 12 | 11.5 | 11.4 | 12.3 | 11.5 | 11.2 | 12.3 | 11.4 | 11.1 | 12.2 | 11.2 | 10.8 | 170 |
| 175 | | | | 11.8 | 11.5 | 11.4 | 12.1 | 11.4 | 11.2 | 12.1 | 11.3 | 11.1 | 12 | 11.1 | 10.8 | 175 |
| 180 | | | | 11.5 | 11.4 | 8.6 | 11.8 | 11.3 | 11.2 | 12 | 11.2 | 11.1 | 11.8 | 11.1 | 10.8 | 180 |
| 185 | | | | 11.2 | 11.3 | 6.2 | 11.6 | 11.3 | 11.2 | 11.8 | 11.2 | 11.1 | 11.7 | 11 | 10.8 | 185 |
| 190 | | | | 10.9 | 11.3 | | 11.4 | 11.3 | 10.3 | 11.6 | 11.1 | 11.1 | 11.5 | 10.9 | 10.8 | 190 |
| 195 | | | | 10.6 | 11.3 | | 11.2 | 11.2 | 7.6 | 11.4 | 11.1 | 11.1 | 11.2 | 10.9 | 10.8 | 195 |
| 200 | | | | 10.2 | 10.7 | | 11 | 11.2 | 5.8 | 11.3 | 11.1 | 11.1 | 11 | 10.9 | 10.8 | 200 |
| 205 | | | | | | | 10.8 | 11.2 | | 11.1 | 11 | 9.1 | 10.7 | 10.9 | 10.8 | 205 |
| 210 | | | | | | | 10.5 | 11.2 | | 10.9 | 11 | 7 | 10.1 | 10.6 | 10.8 | 210 |
| 215 | | | | | | | 7.7 | 10.6 | | 10.7 | 10.9 | 5.4 | 9.4 | 10.2 | 10.3 | 215 |
| 220 | | | | | | | | | | 10.1 | 10.7 | | 9 | 9.4 | 8.2 | 220 |
| 225 | | | | | | | | | | 8.8 | 9.9 | | 8.7 | 8.8 | 6.4 | 225 |
| 230 | | | | | | | | | | 6 | 8.1 | | 8.3 | 8.5 | 5.2 | 230 |
| 235 | | | | | | | | | | | 3 | | 8 | 8.2 | | 235 |
| 240 | | | | | | | | | | | | | 7 | 7.9 | | 240 |
| 245 | | | | | | | | | | | | | 5.2 | 6.5 | | 245 |
| 250 | | | | | | | | | | | | | | 5.2 | | 250 |

t_240_002_56301_00_000

Lifting capacities Forces de levage

TNZK

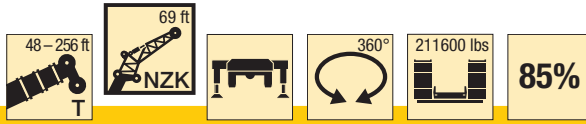

| ft | 208 ft | | | 224 ft | | | 240 ft | | | 253 ft | | | 256 ft | | | ft |
|-----|--------|------|------|--------|------|------|--------|------|------|--------|------|-----|--------|-----|-----|-----|
| | 69 ft | | | 69 ft | | | 69 ft | | | 69 ft | | | 69 ft | | | |
| | 0° | 20° | 40° | 0° | 20° | 40° | 0° | 20° | 40° | 0° | 20° | 40° | 0° | 20° | 40° | |
| 45 | 15.8 | | | | | | | | | | | | | | | 45 |
| 50 | 15.9 | | | 14 | | | | | | | | | | | | 50 |
| 55 | 15.9 | | | 14.1 | | | 12.2 | | | | | | | | | 55 |
| 60 | 15.8 | | | 14.1 | | | 12.2 | | | 10.6 | | | 10.4 | | | 60 |
| 65 | 15.7 | | | 14 | | | 12.2 | | | 10.6 | | | 10.4 | | | 65 |
| 70 | 15.6 | 14.1 | | 14 | | | 12.2 | | | 10.7 | | | 10.4 | | | 70 |
| 75 | 15.5 | 13.9 | | 13.8 | | | 12.1 | | | 10.7 | | | 10.5 | | | 75 |
| 80 | 15.2 | 13.6 | | 13.7 | 12.6 | | 12.1 | | | 10.7 | | | 10.4 | | | 80 |
| 85 | 15 | 13.4 | | 13.6 | 12.5 | | 12 | 11.3 | | 10.6 | | | 10.4 | | | 85 |
| 90 | 14.8 | 13.2 | 11.7 | 13.4 | 12.3 | | 11.9 | 11.2 | | 10.6 | 10.2 | | 10.4 | 10 | | 90 |
| 95 | 14.6 | 13 | 11.5 | 13.2 | 12.1 | 11.1 | 11.8 | 11.1 | | 10.5 | 10.1 | | 10.3 | 9.9 | | 95 |
| 100 | 14.4 | 12.8 | 11.4 | 13.1 | 12 | 11 | 11.7 | 11 | | 10.4 | 10.1 | | 10.3 | 9.9 | | 100 |
| 105 | 14.2 | 12.6 | 11.3 | 13 | 11.9 | 10.9 | 11.6 | 10.9 | 10.3 | 10.4 | 10 | | 10.2 | 9.8 | | 105 |
| 110 | 14 | 12.4 | 11.2 | 12.8 | 11.7 | 10.8 | 11.5 | 10.8 | 10.3 | 10.3 | 9.9 | 9.6 | 10.1 | 9.8 | 9.5 | 110 |
| 115 | 13.8 | 12.3 | 11.1 | 12.7 | 11.6 | 10.7 | 11.4 | 10.7 | 10.2 | 10.2 | 9.8 | 9.5 | 10 | 9.7 | 9.4 | 115 |
| 120 | 13.6 | 12.1 | 11 | 12.5 | 11.5 | 10.6 | 11.2 | 10.6 | 10.1 | 10.1 | 9.6 | 9.4 | 10 | 9.5 | 9.3 | 120 |
| 125 | 13.4 | 12 | 11 | 12.4 | 11.4 | 10.6 | 11.1 | 10.5 | 10.1 | 10 | 9.4 | 9.2 | 9.9 | 9.4 | 9.1 | 125 |
| 130 | 13.2 | 11.8 | 10.9 | 12.2 | 11.2 | 10.5 | 10.9 | 10.4 | 10 | 9.8 | 9.2 | 8.9 | 9.7 | 9.1 | 8.9 | 130 |
| 135 | 13 | 11.7 | 10.8 | 12.1 | 11.1 | 10.5 | 10.8 | 10.2 | 9.9 | 9.5 | 9 | 8.7 | 9.4 | 8.9 | 8.7 | 135 |
| 140 | 12.8 | 11.5 | 10.8 | 11.9 | 11 | 10.5 | 10.6 | 10 | 9.7 | 9.2 | 8.7 | 8.5 | 9.2 | 8.7 | 8.5 | 140 |
| 145 | 12.6 | 11.4 | 10.7 | 11.8 | 10.9 | 10.4 | 10.4 | 9.8 | 9.5 | 9 | 8.5 | 8.3 | 8.9 | 8.5 | 8.3 | 145 |
| 150 | 12.4 | 11.3 | 10.7 | 11.6 | 10.8 | 10.4 | 10.2 | 9.5 | 9.3 | 8.7 | 8.3 | 8.1 | 8.7 | 8.3 | 8.1 | 150 |
| 155 | 12.2 | 11.2 | 10.7 | 11.5 | 10.7 | 10.4 | 10 | 9.3 | 9.1 | 8.5 | 8.1 | 7.9 | 8.4 | 8.1 | 7.9 | 155 |
| 160 | 12.1 | 11.1 | 10.6 | 11.3 | 10.6 | 10.3 | 9.7 | 9.1 | 8.9 | 8.2 | 7.9 | 7.8 | 8.2 | 7.9 | 7.8 | 160 |
| 165 | 11.9 | 11 | 10.6 | 11.1 | 10.5 | 10.3 | 9.5 | 8.9 | 8.8 | 8 | 7.7 | 7.6 | 7.9 | 7.7 | 7.6 | 165 |
| 170 | 11.8 | 10.9 | 10.6 | 10.8 | 10.4 | 10.3 | 9.2 | 8.7 | 8.6 | 7.7 | 7.6 | 7.5 | 7.7 | 7.5 | 7.5 | 170 |
| 175 | 11.6 | 10.9 | 10.6 | 10.5 | 10.2 | 10.3 | 8.9 | 8.5 | 8.4 | 7.4 | 7.4 | 7.3 | 7.4 | 7.4 | 7.3 | 175 |
| 180 | 11.4 | 10.8 | 10.6 | 10.2 | 10 | 10.2 | 8.7 | 8.3 | 8.2 | 7.2 | 7.2 | 7.2 | 7.2 | 7.2 | 7.2 | 180 |
| 185 | 11.1 | 10.7 | 10.6 | 9.9 | 9.8 | 10 | 8.5 | 8.1 | 8.1 | 7 | 7 | 7 | 6.9 | 7 | 7 | 185 |
| 190 | 10.8 | 10.7 | 10.6 | 9.6 | 9.6 | 9.8 | 8.2 | 8 | 7.9 | 6.8 | 6.8 | 6.9 | 6.7 | 6.8 | 6.9 | 190 |
| 195 | 10.6 | 10.6 | 10.6 | 9.3 | 9.3 | 9.6 | 7.9 | 7.8 | 7.8 | 6.6 | 6.7 | 6.8 | 6.5 | 6.6 | 6.7 | 195 |
| 200 | 10.3 | 10.5 | 10.6 | 9.1 | 9.1 | 9.3 | 7.7 | 7.6 | 7.6 | 6.4 | 6.5 | 6.6 | 6.3 | 6.4 | 6.6 | 200 |
| 205 | 9.9 | 10.2 | 10.5 | 8.8 | 8.8 | 9 | 7.5 | 7.5 | 7.5 | 6.2 | 6.3 | 6.4 | 6.2 | 6.2 | 6.4 | 205 |
| 210 | 9.5 | 9.8 | 10.2 | 8.5 | 8.5 | 8.7 | 7.3 | 7.3 | 7.4 | 6 | 6.1 | 6.2 | 6 | 6 | 6.2 | 210 |
| 215 | 9.1 | 9.5 | 9.9 | 8.2 | 8.3 | 8.5 | 7.1 | 7.1 | 7.2 | 5.8 | 5.9 | 6 | 5.8 | 5.9 | 6 | 215 |
| 220 | 8.6 | 9.1 | 9.4 | 7.9 | 8 | 8.2 | 6.9 | 6.9 | 7.1 | 5.6 | 5.7 | 5.9 | 5.6 | 5.7 | 5.8 | 220 |
| 225 | 7.9 | 8.7 | 8.9 | 7.6 | 7.7 | 8 | 6.7 | 6.8 | 6.9 | 5.5 | 5.5 | 5.7 | 5.3 | 5.5 | 5.7 | 225 |
| 230 | 7.3 | 8.1 | 8.4 | 7.3 | 7.5 | 7.7 | 6.5 | 6.6 | 6.8 | 5.3 | 5.4 | 5.5 | 5 | 5.3 | 5.5 | 230 |
| 235 | 7 | 7.5 | 7.5 | 6.9 | 7.2 | 7.4 | 6.3 | 6.4 | 6.6 | 5.1 | 5.2 | 5.4 | 4.7 | 5.2 | 5.3 | 235 |
| 240 | 6.8 | 7 | 6.1 | 6.5 | 6.9 | 7.1 | 6.1 | 6.3 | 6.4 | 5 | 5 | 5.2 | 4.5 | 5 | 5.1 | 240 |
| 245 | 6.6 | 6.7 | 5 | 6.1 | 6.6 | 6.8 | 5.9 | 6.1 | 6.2 | 4.8 | 4.9 | 5 | 4.2 | 4.7 | 4.8 | 245 |
| 250 | 6.4 | 6.5 | | 5.7 | 6.2 | 6.3 | 5.7 | 5.9 | 6.1 | 4.6 | 4.7 | 4.9 | 3.9 | 4.4 | 4.5 | 250 |
| 255 | 5.7 | 6.2 | | 5.5 | 5.7 | 5.7 | 5.4 | 5.7 | 5.9 | 4.4 | 4.6 | 4.7 | 3.6 | 4.1 | 4.2 | 255 |
| 260 | 4.9 | 5.4 | | 5.4 | 5.4 | | 4.9 | 5.4 | 5.6 | 4.2 | 4.4 | 4.5 | 3.3 | 3.7 | 3.9 | 260 |
| 265 | | 3.4 | | 5.2 | 5.3 | | 4.4 | 5.1 | 5.3 | 4 | 4.2 | 4.4 | 3 | 3.4 | 3.5 | 265 |
| 270 | | | | 4.7 | 5.1 | | 3.9 | 4.5 | 4.6 | 3.7 | 4 | 4.1 | 2.7 | 3.1 | 3.2 | 270 |
| 275 | | | | 2.8 | 4.5 | | 3.3 | 3.9 | | 3.3 | 3.8 | 3.9 | 2.4 | 2.8 | 2.9 | 275 |
| 280 | | | | | | | 2.8 | 3.4 | | 2.5 | 3.4 | 3.5 | | 2.5 | 2.5 | 280 |
| 285 | | | | | | | | 2.8 | | | 2.9 | 2.9 | | | | 285 |

t_240_002_56301_00_000

Lifting heights Hauteurs de levage

TNZK

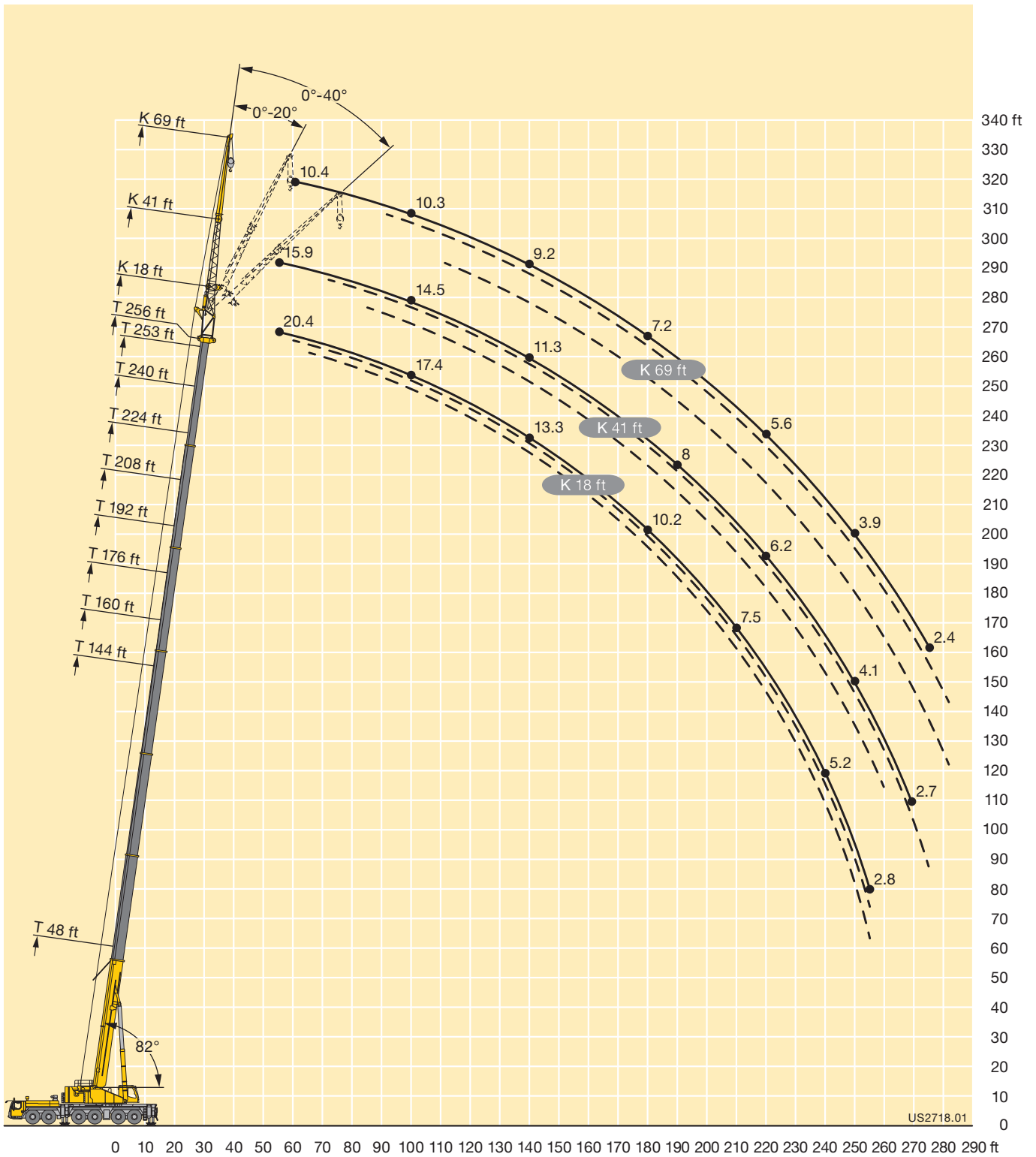

Lifting capacities Forces de levage

TNZK



| ft | 48 ft | | | 144 ft | | | 160 ft | | | 176 ft | | | 192 ft | | | ft |
|------|-------|------|------|--------|------|------|--------|------|------|--------|------|------|--------|------|------|------|
| | 64 ft | | | 64 ft | | | 64 ft | | | 64 ft | | | 64 ft | | | |
| | 0° | 20° | 40° | 0° | 20° | 40° | 0° | 20° | 40° | 0° | 20° | 40° | 0° | 20° | 40° | |
| 12 | 31.4 | | | | | | | | | | | | | | | 12 |
| 13 | 31.4 | | | | | | | | | | | | | | | 13 |
| 14 | 31.4 | | | | | | | | | | | | | | | 14 |
| 15 | 31.4 | | | | | | | | | | | | | | | 15 |
| 16 | 31.2 | | | | | | | | | | | | | | | 16 |
| 17 | 31 | | | | | | | | | | | | | | | 17 |
| 18 | 30.7 | | | | | | | | | | | | | | | 18 |
| 19 | 30.5 | | | | | | | | | | | | | | | 19 |
| 20 | 30.2 | | | | | | | | | | | | | | | 20 |
| 22 | 29.6 | | | | | | | | | | | | | | | 22 |
| 24 | 29 | | | | | | | | | | | | | | | 24 |
| 26 | 28.4 | | | | | | | | | | | | | | | 26 |
| 27.7 | | | | 31.4 | | | | | | | | | | | | 27.7 |
| 30 | 27.1 | | | 31.4 | | | 27 | | | | | | | | | 30 |
| 32 | 26.4 | 22.9 | | 31.4 | | | 27 | | | | | | | | | 32 |
| 34 | 25.8 | 22.3 | | 31.3 | | | 27 | | | 24.9 | | | | | | 34 |
| 36 | 25.2 | 21.6 | | 31.1 | | | 27 | | | 24.9 | | | | | | 36 |
| 38 | 24.6 | 21 | | 30.9 | | | 27 | | | 24.9 | | | 22.1 | | | 38 |
| 40 | 24 | 20.4 | | 30.6 | | | 27 | | | 25 | | | 22.1 | | | 40 |
| 45 | 22.6 | 19.1 | | 29.8 | | | 27 | | | 25 | | | 22.1 | | | 45 |
| 50 | 21.2 | 17.9 | 15.1 | 29 | 22.7 | | 26.9 | | | 25 | | | 22.2 | | | 50 |
| 55 | 19.7 | 16.9 | 14.3 | 28.1 | 21.8 | | 26.7 | 22.3 | | 24.7 | | | 22.1 | | | 55 |
| 60 | 18.2 | 16 | 13.7 | 27.3 | 21 | | 26.1 | 21.7 | | 24.3 | 20.9 | | 21.9 | | | 60 |
| 65 | 16.9 | 15.2 | 13.1 | 26.4 | 20.3 | 15.4 | 25.5 | 21.2 | | 23.9 | 20.4 | | 21.6 | 19.3 | | 65 |
| 70 | 15.6 | 14.5 | 12.6 | 25.6 | 19.6 | 15 | 25 | 20.6 | 15.9 | 23.4 | 19.9 | | 21.3 | 18.9 | | 70 |
| 75 | 14.5 | 13.8 | 12.2 | 24.8 | 18.9 | 14.6 | 24.3 | 20.1 | 15.7 | 23 | 19.5 | 15.5 | 21 | 18.6 | | 75 |
| 80 | 13.6 | 13.2 | 11.9 | 24 | 18.3 | 14.3 | 23.7 | 19.6 | 15.4 | 22.5 | 19.1 | 15.2 | 20.7 | 18.2 | 14.9 | 80 |
| 85 | 12.7 | 12.7 | 11.7 | 23.2 | 17.8 | 14 | 23.1 | 19.1 | 15.1 | 22.1 | 18.7 | 14.9 | 20.4 | 17.9 | 14.6 | 85 |
| 90 | 11.9 | 12.2 | 11.6 | 22.4 | 17.2 | 13.7 | 22.5 | 18.6 | 14.8 | 21.6 | 18.2 | 14.7 | 20 | 17.5 | 14.4 | 90 |
| 95 | 11.3 | 11.8 | 11.6 | 21.7 | 16.7 | 13.4 | 21.9 | 18.1 | 14.5 | 21.1 | 17.8 | 14.4 | 19.7 | 17.2 | 14.2 | 95 |
| 100 | 10.7 | 11.6 | 5.1 | 20.9 | 16.2 | 13.1 | 21.4 | 17.6 | 14.3 | 20.7 | 17.4 | 14.2 | 19.4 | 16.8 | 14 | 100 |
| 105 | 10.3 | | | 20.1 | 15.8 | 12.9 | 20.8 | 17.1 | 14.1 | 20.2 | 17 | 14 | 19.1 | 16.5 | 13.8 | 105 |
| 110 | | | | 19.3 | 15.4 | 12.7 | 20.3 | 16.7 | 13.9 | 19.8 | 16.6 | 13.8 | 18.8 | 16.2 | 13.6 | 110 |
| 115 | | | | 18.5 | 15 | 12.5 | 19.8 | 16.3 | 13.7 | 19.4 | 16.2 | 13.6 | 18.4 | 15.9 | 13.4 | 115 |
| 120 | | | | 17.7 | 14.7 | 12.3 | 19.3 | 15.9 | 13.5 | 18.9 | 15.9 | 13.4 | 18.1 | 15.5 | 13.2 | 120 |
| 125 | | | | 17 | 14.3 | 12.1 | 18.8 | 15.6 | 13.3 | 18.5 | 15.6 | 13.3 | 17.8 | 15.2 | 13.1 | 125 |
| 130 | | | | 16.3 | 14 | 12 | 18.3 | 15.3 | 13.2 | 18.1 | 15.2 | 13.1 | 17.5 | 15 | 13 | 130 |
| 135 | | | | 15.6 | 13.7 | 11.9 | 17.8 | 14.9 | 13 | 17.7 | 15 | 13 | 17.2 | 14.7 | 12.8 | 135 |
| 140 | | | | 15 | 13.4 | 11.8 | 17.3 | 14.6 | 12.9 | 17.3 | 14.7 | 12.9 | 16.8 | 14.4 | 12.8 | 140 |
| 145 | | | | 14.5 | 13.1 | 11.7 | 16.9 | 14.3 | 12.8 | 16.9 | 14.4 | 12.8 | 16.5 | 14.2 | 12.7 | 145 |
| 150 | | | | 14 | 12.9 | 11.7 | 16.4 | 14 | 12.8 | 16.5 | 14.1 | 12.7 | 16.2 | 14 | 12.6 | 150 |
| 155 | | | | 13.5 | 12.6 | 11.6 | 15.9 | 13.8 | 12.7 | 16.1 | 13.9 | 12.7 | 15.8 | 13.7 | 12.5 | 155 |
| 160 | | | | 13 | 12.3 | 11.6 | 15.4 | 13.5 | 12.6 | 15.7 | 13.6 | 12.6 | 15.5 | 13.5 | 12.5 | 160 |
| 165 | | | | 12.5 | 12.1 | 11.6 | 14.9 | 13.3 | 12.6 | 15.3 | 13.3 | 12.6 | 15.1 | 13.3 | 12.4 | 165 |
| 170 | | | | 12.1 | 12 | 11.6 | 14.4 | 13 | 12.6 | 14.9 | 13.1 | 12.5 | 14.7 | 13.1 | 12.4 | 170 |
| 175 | | | | 11.8 | 11.8 | 8.6 | 13.9 | 12.8 | 12.6 | 14.5 | 12.9 | 12.5 | 14.2 | 12.9 | 12.3 | 175 |
| 180 | | | | 11.4 | 11.7 | 6.3 | 13.5 | 12.6 | 12.6 | 14.1 | 12.7 | 12.5 | 13.8 | 12.7 | 12.3 | 180 |
| 185 | | | | 11.1 | 11.6 | | 13.1 | 12.5 | 10.6 | 13.7 | 12.5 | 12.4 | 13.3 | 12.5 | 12.3 | 185 |
| 190 | | | | 10.8 | 11.6 | | 12.7 | 12.3 | 7.6 | 13.3 | 12.4 | 12.4 | 12.7 | 12.2 | 12.3 | 190 |
| 195 | | | | 10.5 | 11.1 | | 12.3 | 12.3 | 5.8 | 12.8 | 12.3 | 11.8 | 12.2 | 12 | 12.3 | 195 |
| 200 | | | | | | | 12 | 12.2 | | 12.4 | 12.2 | 9.1 | 11.3 | 11.8 | 12 | 200 |
| 205 | | | | | | | 11.5 | 12.2 | | 11.9 | 11.9 | 7 | 10.5 | 11.4 | 11.6 | 205 |
| 210 | | | | | | | 8.2 | 10.9 | | 11.2 | 11.5 | 5.5 | 9.7 | 10.6 | 10.6 | 210 |
| 215 | | | | | | | | 3.8 | | 10.5 | 11 | | 9.4 | 9.7 | 8.2 | 215 |
| 220 | | | | | | | | | | 9.3 | 10.2 | | 9 | 9.2 | 6.5 | 220 |
| 225 | | | | | | | | | | 6.3 | 8.4 | | 8.7 | 8.8 | 5.2 | 225 |
| 230 | | | | | | | | | | | 3.4 | | 8.3 | 8.5 | | 230 |
| 235 | | | | | | | | | | | | | 7.4 | 8.1 | | 235 |
| 240 | | | | | | | | | | | | | 5.4 | 6.8 | | 240 |
| 245 | | | | | | | | | | | | | 4.1 | 5.4 | | 245 |

t_240_002_56201_00_000

Lifting capacities Forces de levage

TNZK

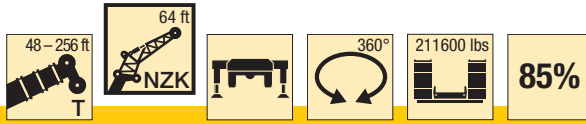

| ft | 208 ft | | | 224 ft | | | 240 ft | | | 253 ft | | | 256 ft | | | ft |
|-----|--------|------|------|--------|------|------|--------|------|------|--------|------|------|--------|------|------|-----|
| | 64 ft | | | 64 ft | | | 64 ft | | | 64 ft | | | 64 ft | | | |
| | 0° | 20° | 40° | 0° | 20° | 40° | 0° | 20° | 40° | 0° | 20° | 40° | 0° | 20° | 40° | |
| 45 | 19.2 | | | | | | | | | | | | | | | 45 |
| 50 | 19.2 | | | 16.4 | | | | | | | | | | | | 50 |
| 55 | 19.3 | | | 16.4 | | | 13.8 | | | | | | | | | 55 |
| 60 | 19.2 | | | 16.4 | | | 13.9 | | | 11.9 | | | 11.6 | | | 60 |
| 65 | 19.1 | | | 16.4 | | | 13.9 | | | 11.9 | | | 11.6 | | | 65 |
| 70 | 18.9 | 17.5 | | 16.4 | | | 13.9 | | | 12 | | | 11.7 | | | 70 |
| 75 | 18.7 | 17.2 | | 16.3 | 15.5 | | 13.9 | | | 12 | | | 11.7 | | | 75 |
| 80 | 18.5 | 17 | | 16.2 | 15.4 | | 13.8 | | | 11.8 | | | 11.6 | | | 80 |
| 85 | 18.3 | 16.7 | 14.2 | 16 | 15.2 | | 13.7 | 13.2 | | 11.7 | | | 11.5 | | | 85 |
| 90 | 18.1 | 16.5 | 14 | 15.9 | 15.1 | | 13.6 | 13.2 | | 11.6 | 11.2 | | 11.4 | 10.9 | | 90 |
| 95 | 17.9 | 16.2 | 13.8 | 15.7 | 14.9 | 13.1 | 13.5 | 13.1 | | 11.5 | 11.2 | | 11.3 | 10.9 | | 95 |
| 100 | 17.7 | 15.9 | 13.6 | 15.6 | 14.8 | 13 | 13.3 | 12.9 | 12.1 | 11.4 | 11.1 | | 11.2 | 10.8 | | 100 |
| 105 | 17.4 | 15.7 | 13.4 | 15.4 | 14.6 | 12.9 | 13.2 | 12.6 | 12 | 11.2 | 10.9 | 10.5 | 11.1 | 10.7 | 10.4 | 105 |
| 110 | 17.2 | 15.4 | 13.2 | 15.2 | 14.4 | 12.7 | 13 | 12.2 | 11.7 | 11.1 | 10.6 | 10.2 | 10.9 | 10.5 | 10.2 | 110 |
| 115 | 17 | 15.2 | 13.1 | 15 | 14.2 | 12.6 | 12.8 | 11.9 | 11.4 | 10.9 | 10.3 | 10 | 10.7 | 10.2 | 9.9 | 115 |
| 120 | 16.8 | 14.9 | 13 | 14.8 | 14 | 12.5 | 12.5 | 11.6 | 11.2 | 10.7 | 10.1 | 9.7 | 10.6 | 10 | 9.7 | 120 |
| 125 | 16.6 | 14.7 | 12.8 | 14.6 | 13.8 | 12.4 | 12.2 | 11.3 | 10.9 | 10.5 | 9.8 | 9.5 | 10.4 | 9.7 | 9.4 | 125 |
| 130 | 16.3 | 14.4 | 12.7 | 14.3 | 13.6 | 12.3 | 11.8 | 11 | 10.6 | 10.2 | 9.6 | 9.3 | 10.1 | 9.5 | 9.2 | 130 |
| 135 | 16.1 | 14.2 | 12.6 | 14 | 13.4 | 12.2 | 11.5 | 10.7 | 10.4 | 9.9 | 9.3 | 9 | 9.8 | 9.2 | 9 | 135 |
| 140 | 15.9 | 14 | 12.5 | 13.7 | 13.2 | 12.2 | 11.2 | 10.5 | 10.1 | 9.6 | 9.1 | 8.8 | 9.5 | 9 | 8.8 | 140 |
| 145 | 15.6 | 13.8 | 12.4 | 13.2 | 12.9 | 12.1 | 10.9 | 10.2 | 9.9 | 9.3 | 8.9 | 8.6 | 9.2 | 8.8 | 8.6 | 145 |
| 150 | 15.2 | 13.6 | 12.4 | 12.8 | 12.6 | 12 | 10.6 | 9.9 | 9.7 | 9 | 8.6 | 8.4 | 8.9 | 8.6 | 8.4 | 150 |
| 155 | 14.8 | 13.4 | 12.3 | 12.4 | 12.2 | 11.9 | 10.4 | 9.7 | 9.5 | 8.7 | 8.4 | 8.2 | 8.6 | 8.4 | 8.2 | 155 |
| 160 | 14.3 | 13.1 | 12.2 | 12 | 11.8 | 11.7 | 10.1 | 9.5 | 9.2 | 8.4 | 8.2 | 8 | 8.3 | 8.2 | 8 | 160 |
| 165 | 13.9 | 12.9 | 12.2 | 11.6 | 11.5 | 11.5 | 9.8 | 9.2 | 9 | 8.1 | 8 | 7.8 | 8.1 | 7.9 | 7.8 | 165 |
| 170 | 13.4 | 12.7 | 12.1 | 11.2 | 11.1 | 11.2 | 9.5 | 9 | 8.9 | 7.8 | 7.8 | 7.7 | 7.8 | 7.7 | 7.7 | 170 |
| 175 | 13 | 12.5 | 12.1 | 10.9 | 10.8 | 10.9 | 9.2 | 8.8 | 8.7 | 7.5 | 7.5 | 7.5 | 7.5 | 7.5 | 7.5 | 175 |
| 180 | 12.5 | 12.2 | 12 | 10.5 | 10.5 | 10.6 | 9 | 8.6 | 8.5 | 7.2 | 7.3 | 7.3 | 7.2 | 7.3 | 7.3 | 180 |
| 185 | 12 | 11.9 | 11.9 | 10.1 | 10.1 | 10.3 | 8.7 | 8.4 | 8.3 | 7 | 7.1 | 7.2 | 7 | 7.1 | 7.1 | 185 |
| 190 | 11.4 | 11.6 | 11.7 | 9.8 | 9.8 | 10 | 8.4 | 8.2 | 8.2 | 6.8 | 6.9 | 7 | 6.8 | 6.9 | 7 | 190 |
| 195 | 10.9 | 11.3 | 11.6 | 9.5 | 9.5 | 9.7 | 8.1 | 8 | 8 | 6.6 | 6.7 | 6.8 | 6.6 | 6.7 | 6.8 | 195 |
| 200 | 10.4 | 10.9 | 11.1 | 9.2 | 9.2 | 9.4 | 7.8 | 7.9 | 7.9 | 6.4 | 6.5 | 6.6 | 6.4 | 6.5 | 6.6 | 200 |
| 205 | 10 | 10.4 | 10.7 | 8.9 | 8.9 | 9.1 | 7.6 | 7.6 | 7.7 | 6.2 | 6.3 | 6.4 | 6.2 | 6.3 | 6.4 | 205 |
| 210 | 9.5 | 9.9 | 10.2 | 8.6 | 8.6 | 8.8 | 7.4 | 7.4 | 7.5 | 6 | 6.1 | 6.2 | 6 | 6.1 | 6.2 | 210 |
| 215 | 8.9 | 9.5 | 9.7 | 8.3 | 8.3 | 8.6 | 7.2 | 7.2 | 7.3 | 5.8 | 5.9 | 6 | 5.8 | 5.9 | 6 | 215 |
| 220 | 8.3 | 9 | 9.2 | 7.9 | 8 | 8.3 | 7 | 7 | 7.1 | 5.7 | 5.7 | 5.9 | 5.5 | 5.7 | 5.9 | 220 |
| 225 | 7.6 | 8.4 | 8.6 | 7.6 | 7.7 | 8 | 6.7 | 6.8 | 6.9 | 5.5 | 5.5 | 5.7 | 5.2 | 5.5 | 5.7 | 225 |
| 230 | 7.3 | 7.7 | 7.5 | 7.2 | 7.4 | 7.7 | 6.5 | 6.6 | 6.8 | 5.3 | 5.4 | 5.5 | 4.9 | 5.3 | 5.5 | 230 |
| 235 | 7 | 7.1 | 6.1 | 6.8 | 7.1 | 7.3 | 6.3 | 6.4 | 6.6 | 5.2 | 5.2 | 5.3 | 4.6 | 5.1 | 5.3 | 235 |
| 240 | 6.8 | 6.9 | 5 | 6.3 | 6.8 | 7 | 6.1 | 6.3 | 6.4 | 5 | 5 | 5.2 | 4.3 | 4.8 | 5 | 240 |
| 245 | 6.6 | 6.6 | | 5.9 | 6.3 | 6.5 | 5.8 | 6.1 | 6.2 | 4.8 | 4.9 | 5 | 4.1 | 4.5 | 4.7 | 245 |
| 250 | 6 | 6.4 | | 5.7 | 5.8 | 5.8 | 5.6 | 5.9 | 6.1 | 4.6 | 4.7 | 4.9 | 3.8 | 4.2 | 4.4 | 250 |
| 255 | 5 | 5.6 | | 5.5 | 5.6 | | 5.1 | 5.6 | 5.8 | 4.4 | 4.6 | 4.7 | 3.5 | 3.8 | 4 | 255 |
| 260 | | 3.6 | | 5.4 | 5.4 | | 4.6 | 5.3 | 5.4 | 4.1 | 4.4 | 4.5 | 3.2 | 3.5 | 3.7 | 260 |
| 265 | | | | 4.9 | 5.3 | | 4 | 4.7 | 4.8 | 3.8 | 4.1 | 4.3 | 2.9 | 3.2 | 3.3 | 265 |
| 270 | | | | 3 | 4.6 | | 3.5 | 4.1 | | 3.3 | 3.9 | 4 | 2.6 | 2.9 | 3 | 270 |
| 275 | | | | | | | 3 | 3.5 | | | 3.5 | 3.6 | | 2.6 | 2.6 | 275 |
| 280 | | | | | | | | 2.9 | | | 2.5 | 2.6 | | | | 280 |

t_240_002_56201_00_000

Lifting capacities Forces de levage

TNZK

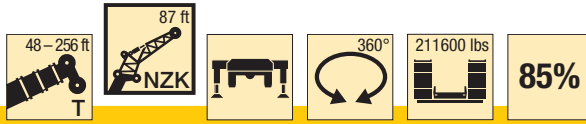

| ft | 48 ft | | | 144 ft | | | 160 ft | | | 176 ft | | | 192 ft | | | ft |
|-----|-------|------|-----|--------|------|-----|--------|------|-----|--------|------|-----|--------|------|-----|-----|
| | 87 ft | | | 87 ft | | | 87 ft | | | 87 ft | | | 87 ft | | | |
| | 0° | 20° | 40° | 0° | 20° | 40° | 0° | 20° | 40° | 0° | 20° | 40° | 0° | 20° | 40° | |
| 14 | 19.4 | | | | | | | | | | | | | | | 14 |
| 15 | 19.4 | | | | | | | | | | | | | | | 15 |
| 16 | 19.4 | | | | | | | | | | | | | | | 16 |
| 17 | 19.4 | | | | | | | | | | | | | | | 17 |
| 18 | 19.4 | | | | | | | | | | | | | | | 18 |
| 19 | 19.5 | | | | | | | | | | | | | | | 19 |
| 20 | 19.4 | | | | | | | | | | | | | | | 20 |
| 22 | 19.3 | | | | | | | | | | | | | | | 22 |
| 24 | 19.1 | | | | | | | | | | | | | | | 24 |
| 26 | 18.9 | | | | | | | | | | | | | | | 26 |
| 28 | 18.5 | | | | | | | | | | | | | | | 28 |
| 30 | 18.2 | | | | | | | | | | | | | | | 30 |
| 32 | 17.8 | | | 19.4 | | | | | | | | | | | | 32 |
| 34 | 17.5 | | | 19.4 | | | 18 | | | | | | | | | 34 |
| 36 | 17.1 | | | 19.5 | | | 18.1 | | | | | | | | | 36 |
| 38 | 16.8 | | | 19.5 | | | 18.1 | | | 16.5 | | | | | | 38 |
| 40 | 16.4 | | | 19.4 | | | 18.1 | | | 16.6 | | | | | | 40 |
| 45 | 15.6 | 13.5 | | 19.2 | | | 18.1 | | | 16.6 | | | 14.9 | | | 45 |
| 50 | 14.8 | 12.7 | | 18.8 | | | 17.8 | | | 16.5 | | | 15 | | | 50 |
| 55 | 14 | 11.9 | | 18.3 | | | 17.5 | | | 16.4 | | | 14.9 | | | 55 |
| 60 | 13.1 | 11.2 | | 17.8 | | | 17 | | | 16.1 | | | 14.7 | | | 60 |
| 65 | 12.4 | 10.6 | 8.9 | 17.2 | 13.4 | | 16.6 | 13.1 | | 15.7 | | | 14.5 | | | 65 |
| 70 | 11.6 | 10 | 8.5 | 16.7 | 12.9 | | 16.2 | 12.7 | | 15.4 | 12.4 | | 14.3 | | | 70 |
| 75 | 10.9 | 9.5 | 8.1 | 16.2 | 12.4 | | 15.8 | 12.3 | | 15 | 12 | | 14 | 11.6 | | 75 |
| 80 | 10.3 | 9 | 7.8 | 15.7 | 12 | | 15.3 | 11.9 | | 14.7 | 11.7 | | 13.7 | 11.3 | | 80 |
| 85 | 9.7 | 8.5 | 7.5 | 15.2 | 11.5 | 8.7 | 14.9 | 11.5 | | 14.3 | 11.3 | | 13.4 | 11 | | 85 |
| 90 | 9.1 | 8.2 | 7.3 | 14.8 | 11.1 | 8.5 | 14.5 | 11.1 | 8.5 | 14 | 11 | 8.4 | 13.2 | 10.7 | | 90 |
| 95 | 8.6 | 7.8 | 7.1 | 14.3 | 10.8 | 8.3 | 14.1 | 10.8 | 8.3 | 13.6 | 10.7 | 8.2 | 12.9 | 10.4 | 8 | 95 |
| 100 | 8.2 | 7.5 | 6.9 | 13.8 | 10.5 | 8.1 | 13.7 | 10.5 | 8.1 | 13.3 | 10.4 | 8 | 12.6 | 10.1 | 7.9 | 100 |
| 105 | 7.8 | 7.3 | 6.8 | 13.3 | 10.1 | 8 | 13.3 | 10.2 | 7.9 | 13 | 10.1 | 7.9 | 12.3 | 9.8 | 7.8 | 105 |
| 110 | 7.3 | 7 | 6.8 | 12.9 | 9.8 | 7.8 | 12.9 | 9.9 | 7.8 | 12.6 | 9.8 | 7.7 | 12.1 | 9.6 | 7.6 | 110 |
| 115 | 7 | 6.9 | 6.8 | 12.4 | 9.5 | 7.6 | 12.5 | 9.6 | 7.6 | 12.3 | 9.6 | 7.6 | 11.8 | 9.3 | 7.5 | 115 |
| 120 | 6.7 | 6.8 | 6.8 | 12 | 9.3 | 7.5 | 12.1 | 9.3 | 7.5 | 12 | 9.3 | 7.5 | 11.5 | 9.1 | 7.4 | 120 |
| 125 | 6.5 | 6.8 | | 11.5 | 9 | 7.4 | 11.7 | 9.1 | 7.4 | 11.6 | 9 | 7.3 | 11.3 | 8.9 | 7.3 | 125 |
| 130 | | | | 11.1 | 8.8 | 7.3 | 11.4 | 8.8 | 7.3 | 11.3 | 8.8 | 7.2 | 11 | 8.7 | 7.2 | 130 |
| 135 | | | | 10.7 | 8.5 | 7.2 | 11 | 8.6 | 7.2 | 11 | 8.6 | 7.1 | 10.7 | 8.5 | 7.1 | 135 |
| 140 | | | | 10.3 | 8.3 | 7.1 | 10.6 | 8.4 | 7.1 | 10.7 | 8.4 | 7 | 10.4 | 8.3 | 7 | 140 |
| 145 | | | | 10 | 8.1 | 7 | 10.2 | 8.2 | 7 | 10.4 | 8.2 | 7 | 10.2 | 8.2 | 6.9 | 145 |
| 150 | | | | 9.6 | 7.9 | 6.9 | 9.9 | 8 | 6.9 | 10.1 | 8.1 | 6.9 | 9.9 | 8 | 6.8 | 150 |
| 155 | | | | 9.3 | 7.8 | 6.9 | 9.6 | 7.9 | 6.9 | 9.8 | 7.9 | 6.8 | 9.7 | 7.8 | 6.8 | 155 |
| 160 | | | | 9 | 7.6 | 6.8 | 9.3 | 7.7 | 6.8 | 9.5 | 7.7 | 6.8 | 9.4 | 7.7 | 6.7 | 160 |
| 165 | | | | 8.8 | 7.4 | 6.8 | 9 | 7.6 | 6.8 | 9.2 | 7.6 | 6.7 | 9.2 | 7.5 | 6.7 | 165 |
| 170 | | | | 8.5 | 7.3 | 6.8 | 8.8 | 7.4 | 6.8 | 9 | 7.4 | 6.7 | 8.9 | 7.4 | 6.6 | 170 |
| 175 | | | | 8.2 | 7.2 | 6.8 | 8.5 | 7.3 | 6.7 | 8.7 | 7.3 | 6.7 | 8.7 | 7.3 | 6.6 | 175 |
| 180 | | | | 7.9 | 7.1 | 6.8 | 8.3 | 7.2 | 6.7 | 8.5 | 7.2 | 6.6 | 8.5 | 7.2 | 6.6 | 180 |
| 185 | | | | 7.7 | 7 | 6.8 | 8.1 | 7.1 | 6.7 | 8.2 | 7.1 | 6.6 | 8.3 | 7.1 | 6.6 | 185 |
| 190 | | | | 7.5 | 6.9 | 6.8 | 7.9 | 7 | 6.7 | 8 | 7 | 6.6 | 8.1 | 7 | 6.5 | 190 |
| 195 | | | | 7.2 | 6.9 | 6.8 | 7.6 | 6.9 | 6.7 | 7.9 | 6.9 | 6.6 | 7.9 | 6.9 | 6.5 | 195 |
| 200 | | | | 7 | 6.8 | 6.8 | 7.4 | 6.8 | 6.7 | 7.7 | 6.9 | 6.6 | 7.7 | 6.8 | 6.5 | 200 |
| 205 | | | | 6.9 | 6.8 | 5.4 | 7.3 | 6.8 | 6.7 | 7.5 | 6.8 | 6.6 | 7.6 | 6.8 | 6.5 | 205 |
| 210 | | | | 6.7 | 6.8 | | 7.1 | 6.8 | 6.7 | 7.4 | 6.7 | 6.6 | 7.5 | 6.7 | 6.5 | 210 |
| 215 | | | | 6.6 | 6.8 | | 6.9 | 6.8 | 6.5 | 7.2 | 6.7 | 6.6 | 7.3 | 6.7 | 6.5 | 215 |
| 220 | | | | 6.1 | 6.8 | | 6.8 | 6.8 | 5.1 | 7.1 | 6.7 | 6.6 | 7.2 | 6.6 | 6.5 | 220 |
| 225 | | | | | | | 6.6 | 6.8 | | 6.9 | 6.7 | 6.6 | 7.1 | 6.6 | 6.5 | 225 |
| 230 | | | | | | | 6.5 | 6.8 | | 6.8 | 6.6 | 6.2 | 6.9 | 6.6 | 6.5 | 230 |
| 235 | | | | | | | 4.4 | 6.6 | | 6.6 | 6.6 | | 6.8 | 6.6 | 6.5 | 235 |
| 240 | | | | | | | | | | 6.6 | 6.6 | | 6.7 | 6.6 | 6.5 | 240 |
| 245 | | | | | | | | | | 5.7 | 6.6 | | 6.6 | 6.6 | 5.9 | 245 |
| 250 | | | | | | | | | | 2.8 | 5.1 | | 6.5 | 6.5 | | 250 |
| 255 | | | | | | | | | | | | | 6.2 | 6.4 | | 255 |
| 260 | | | | | | | | | | | | | 4.4 | 6.2 | | 260 |
| 265 | | | | | | | | | | | | | 3.9 | 4 | | 265 |

t_240_002_56401_00_000

Lifting capacities Forces de levage

TNZK



| ft | 208 ft | | | 224 ft | | | 240 ft | | | 253 ft | | | 256 ft | | | ft |
|-----|--------|------|-----|--------|-----|-----|--------|-----|-----|--------|-----|-----|--------|-----|-----|-----|
| | 87 ft | | | 87 ft | | | 87 ft | | | 87 ft | | | 87 ft | | | |
| | 0° | 20° | 40° | 0° | 20° | 40° | 0° | 20° | 40° | 0° | 20° | 40° | 0° | 20° | 40° | |
| 50 | 13.1 | | | | | | | | | | | | | | | 50 |
| 55 | 13.1 | | | 11.2 | | | | | | | | | | | | 55 |
| 60 | 13.1 | | | 11.3 | | | 9.4 | | | | | | | | | 60 |
| 65 | 13 | | | 11.3 | | | 9.5 | | | 7.8 | | | 7.5 | | | 65 |
| 70 | 12.9 | | | 11.2 | | | 9.5 | | | 8.1 | | | 7.8 | | | 70 |
| 75 | 12.7 | | | 11.1 | | | 9.5 | | | 8.2 | | | 7.9 | | | 75 |
| 80 | 12.5 | 10.6 | | 11 | | | 9.5 | | | 8.2 | | | 7.9 | | | 80 |
| 85 | 12.3 | 10.4 | | 10.9 | | | 9.4 | | | 8.1 | | | 7.9 | | | 85 |
| 90 | 12.1 | 10.1 | | 10.8 | 9.4 | | 9.3 | | | 8 | | | 7.8 | | | 90 |
| 95 | 11.9 | 9.9 | | 10.6 | 9.2 | | 9.2 | 8.4 | | 7.9 | | | 7.7 | | | 95 |
| 100 | 11.7 | 9.7 | | 10.5 | 9 | | 9.1 | 8.3 | | 7.8 | 7.4 | | 7.7 | | | 100 |
| 105 | 11.4 | 9.4 | 7.6 | 10.3 | 8.8 | | 9 | 8.1 | | 7.8 | 7.3 | | 7.6 | 7.3 | | 105 |
| 110 | 11.2 | 9.2 | 7.4 | 10.2 | 8.7 | 7.1 | 8.9 | 8 | | 7.7 | 7.3 | | 7.6 | 7.3 | | 110 |
| 115 | 11 | 9 | 7.3 | 10 | 8.5 | 7.1 | 8.8 | 7.9 | 6.7 | 7.7 | 7.3 | | 7.5 | 7.2 | | 115 |
| 120 | 10.8 | 8.8 | 7.2 | 9.9 | 8.4 | 7 | 8.7 | 7.7 | 6.7 | 7.6 | 7.2 | | 7.5 | 7.1 | | 120 |
| 125 | 10.6 | 8.6 | 7.1 | 9.7 | 8.2 | 6.9 | 8.6 | 7.6 | 6.7 | 7.6 | 7.1 | 6.4 | 7.5 | 7 | 6.4 | 125 |
| 130 | 10.4 | 8.5 | 7 | 9.6 | 8 | 6.8 | 8.5 | 7.5 | 6.6 | 7.6 | 7 | 6.4 | 7.4 | 6.9 | 6.3 | 130 |
| 135 | 10.2 | 8.3 | 7 | 9.4 | 7.9 | 6.8 | 8.4 | 7.4 | 6.5 | 7.5 | 6.9 | 6.3 | 7.4 | 6.9 | 6.3 | 135 |
| 140 | 10 | 8.1 | 6.9 | 9.3 | 7.8 | 6.7 | 8.3 | 7.3 | 6.5 | 7.4 | 6.8 | 6.3 | 7.2 | 6.8 | 6.2 | 140 |
| 145 | 9.8 | 8 | 6.8 | 9.1 | 7.6 | 6.7 | 8.2 | 7.2 | 6.4 | 7.2 | 6.8 | 6.2 | 7.1 | 6.7 | 6.2 | 145 |
| 150 | 9.5 | 7.8 | 6.7 | 9 | 7.5 | 6.6 | 8.1 | 7.1 | 6.4 | 7.1 | 6.7 | 6.2 | 7 | 6.6 | 6.2 | 150 |
| 155 | 9.3 | 7.7 | 6.7 | 8.8 | 7.4 | 6.5 | 8 | 7 | 6.4 | 6.9 | 6.6 | 6.1 | 6.9 | 6.5 | 6.1 | 155 |
| 160 | 9.1 | 7.5 | 6.6 | 8.6 | 7.3 | 6.5 | 7.8 | 6.9 | 6.3 | 6.8 | 6.4 | 6.1 | 6.7 | 6.4 | 6.1 | 160 |
| 165 | 8.9 | 7.4 | 6.6 | 8.5 | 7.2 | 6.5 | 7.6 | 6.8 | 6.3 | 6.7 | 6.3 | 6 | 6.6 | 6.3 | 6 | 165 |
| 170 | 8.7 | 7.3 | 6.5 | 8.3 | 7.1 | 6.4 | 7.4 | 6.7 | 6.2 | 6.5 | 6.2 | 6 | 6.4 | 6.1 | 5.9 | 170 |
| 175 | 8.5 | 7.2 | 6.5 | 8.1 | 7 | 6.4 | 7.3 | 6.7 | 6.2 | 6.3 | 6 | 5.9 | 6.3 | 6 | 5.9 | 175 |
| 180 | 8.3 | 7.1 | 6.5 | 8 | 6.9 | 6.4 | 7.1 | 6.6 | 6.2 | 6.1 | 5.9 | 5.8 | 6.1 | 5.9 | 5.8 | 180 |
| 185 | 8.1 | 7 | 6.4 | 7.8 | 6.8 | 6.3 | 6.9 | 6.5 | 6.2 | 6 | 5.7 | 5.7 | 5.9 | 5.7 | 5.7 | 185 |
| 190 | 8 | 6.9 | 6.4 | 7.7 | 6.7 | 6.3 | 6.8 | 6.4 | 6.2 | 5.8 | 5.6 | 5.6 | 5.7 | 5.6 | 5.5 | 190 |
| 195 | 7.8 | 6.8 | 6.4 | 7.5 | 6.7 | 6.3 | 6.6 | 6.3 | 6.1 | 5.6 | 5.5 | 5.5 | 5.5 | 5.5 | 5.4 | 195 |
| 200 | 7.7 | 6.7 | 6.4 | 7.4 | 6.6 | 6.3 | 6.5 | 6.2 | 6.1 | 5.4 | 5.4 | 5.4 | 5.3 | 5.4 | 5.3 | 200 |
| 205 | 7.5 | 6.7 | 6.4 | 7.2 | 6.5 | 6.3 | 6.3 | 6 | 6 | 5.2 | 5.3 | 5.3 | 5.2 | 5.3 | 5.2 | 205 |
| 210 | 7.4 | 6.6 | 6.4 | 7.1 | 6.5 | 6.3 | 6.2 | 5.9 | 5.9 | 5 | 5.1 | 5.2 | 5 | 5.1 | 5.2 | 210 |
| 215 | 7.2 | 6.6 | 6.4 | 6.9 | 6.5 | 6.3 | 6.1 | 5.8 | 5.8 | 4.8 | 5 | 5.1 | 4.8 | 5 | 5.1 | 215 |
| 220 | 7.1 | 6.5 | 6.4 | 6.8 | 6.4 | 6.3 | 5.9 | 5.7 | 5.7 | 4.6 | 4.8 | 5 | 4.6 | 4.8 | 4.9 | 220 |
| 225 | 6.9 | 6.5 | 6.4 | 6.6 | 6.4 | 6.3 | 5.8 | 5.6 | 5.6 | 4.5 | 4.7 | 4.8 | 4.5 | 4.7 | 4.8 | 225 |
| 230 | 6.8 | 6.5 | 6.4 | 6.5 | 6.3 | 6.3 | 5.6 | 5.5 | 5.6 | 4.3 | 4.5 | 4.7 | 4.3 | 4.5 | 4.7 | 230 |
| 235 | 6.7 | 6.4 | 6.4 | 6.3 | 6.2 | 6.3 | 5.4 | 5.4 | 5.5 | 4.1 | 4.3 | 4.6 | 4.1 | 4.3 | 4.6 | 235 |
| 240 | 6.4 | 6.4 | 6.4 | 6 | 6.1 | 6.3 | 5.3 | 5.3 | 5.4 | 3.9 | 4.2 | 4.4 | 3.8 | 4.1 | 4.4 | 240 |
| 245 | 6 | 6.3 | 6.4 | 5.8 | 6 | 6.2 | 5.1 | 5.2 | 5.3 | 3.8 | 4 | 4.3 | 3.6 | 4 | 4.3 | 245 |
| 250 | 5.6 | 6.1 | 6.4 | 5.5 | 5.8 | 6.1 | 4.9 | 5 | 5.2 | 3.6 | 3.9 | 4.1 | 3.3 | 3.8 | 4.1 | 250 |
| 255 | 5.4 | 5.8 | 6 | 5.1 | 5.6 | 5.8 | 4.7 | 4.9 | 5.1 | 3.5 | 3.7 | 3.9 | 3 | 3.6 | 3.9 | 255 |
| 260 | 5.2 | 5.4 | 5.5 | 4.6 | 5.4 | 5.5 | 4.5 | 4.8 | 4.9 | 3.3 | 3.6 | 3.8 | 2.8 | 3.3 | 3.7 | 260 |
| 265 | 5.1 | 5.2 | | 4.4 | 5 | 5.2 | 4.2 | 4.6 | 4.8 | 3.1 | 3.4 | 3.6 | | 3.1 | 3.3 | 265 |
| 270 | 4.9 | 5 | | 4.2 | 4.4 | 4.6 | 3.9 | 4.5 | 4.6 | | 3.2 | 3.4 | | 2.8 | 3 | 270 |
| 275 | 3.7 | 4.8 | | 4.1 | 4.2 | 4.4 | 3.4 | 4.2 | 4.4 | | 3 | 3.2 | | 2.5 | 2.7 | 275 |
| 280 | | 3.6 | | 4 | 4.1 | | 2.8 | 3.8 | 4 | | 2.8 | 3 | | | 2.3 | 280 |
| 285 | | | | 3.8 | 3.9 | | | 3.3 | 3.4 | | | 2.6 | | | | 285 |
| 290 | | | | 2.3 | 3.8 | | | 2.4 | 2.5 | | | | | | | 290 |

t_240_002_56401_00_000

Lifting heights Hauteurs de levage

TNZK

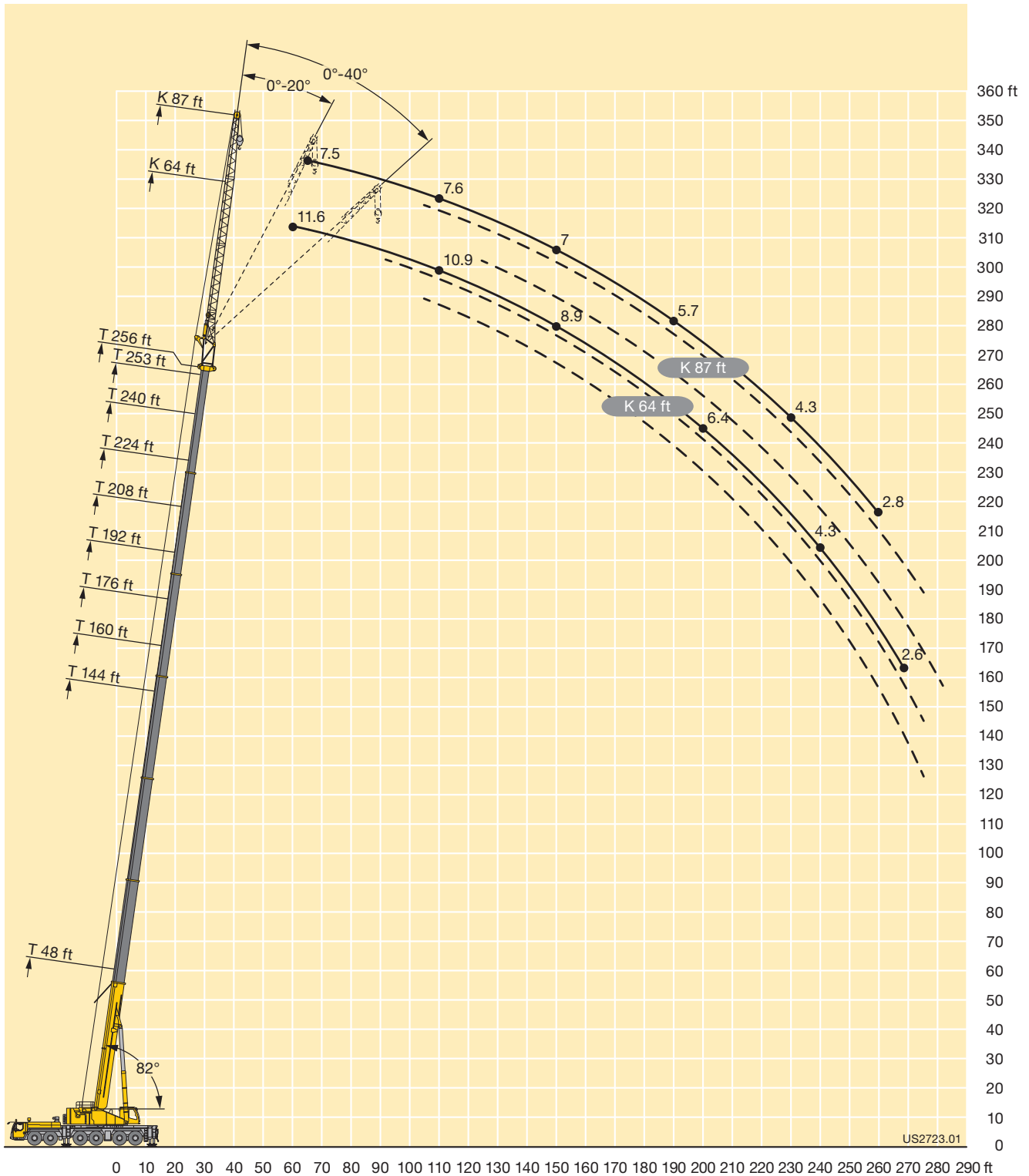

Lifting capacities Forces de levage

TNZK



| ft | 48 ft | | | 144 ft | | | 160 ft | | | 176 ft | | | 192 ft | | | ft |
|-----|-------|------|-----|--------|------|-----|--------|------|-----|--------|------|-----|--------|------|-----|-----|
| | 92 ft | | | 92 ft | | | 92 ft | | | 92 ft | | | 92 ft | | | |
| | 0° | 20° | 40° | 0° | 20° | 40° | 0° | 20° | 40° | 0° | 20° | 40° | 0° | 20° | 40° | |
| 15 | 15.9 | | | | | | | | | | | | | | | 15 |
| 16 | 15.9 | | | | | | | | | | | | | | | 16 |
| 17 | 15.9 | | | | | | | | | | | | | | | 17 |
| 18 | 15.9 | | | | | | | | | | | | | | | 18 |
| 19 | 15.9 | | | | | | | | | | | | | | | 19 |
| 20 | 16 | | | | | | | | | | | | | | | 20 |
| 22 | 15.9 | | | | | | | | | | | | | | | 22 |
| 24 | 15.9 | | | | | | | | | | | | | | | 24 |
| 26 | 15.8 | | | | | | | | | | | | | | | 26 |
| 28 | 15.6 | | | | | | | | | | | | | | | 28 |
| 30 | 15.4 | | | | | | | | | | | | | | | 30 |
| 32 | 15.2 | | | 15.4 | | | | | | | | | | | | 32 |
| 34 | 15 | | | 15.8 | | | | | | | | | | | | 34 |
| 36 | 14.8 | | | 15.9 | | | 14.9 | | | | | | | | | 36 |
| 38 | 14.5 | | | 16 | | | 15.1 | | | | | | | | | 38 |
| 40 | 14.3 | | | 15.9 | | | 15.2 | | | 14.1 | | | | | | 40 |
| 45 | 13.7 | | | 15.9 | | | 15.2 | | | 14.2 | | | 12.9 | | | 45 |
| 50 | 13.1 | 11.6 | | 15.7 | | | 15 | | | 14.2 | | | 13 | | | 50 |
| 55 | 12.5 | 10.9 | | 15.4 | | | 14.8 | | | 14 | | | 13 | | | 55 |
| 60 | 11.9 | 10.3 | | 15.1 | | | 14.6 | | | 13.8 | | | 12.9 | | | 60 |
| 65 | 11.2 | 9.7 | | 14.8 | 12 | | 14.3 | | | 13.6 | | | 12.7 | | | 65 |
| 70 | 10.6 | 9.2 | 7.8 | 14.4 | 11.6 | | 14 | 11.5 | | 13.3 | | | 12.5 | | | 70 |
| 75 | 10.1 | 8.8 | 7.5 | 14.1 | 11.2 | | 13.7 | 11.1 | | 13.1 | 10.9 | | 12.3 | | | 75 |
| 80 | 9.5 | 8.3 | 7.2 | 13.7 | 10.8 | | 13.4 | 10.7 | | 12.8 | 10.5 | | 12.1 | 10.2 | | 80 |
| 85 | 9 | 8 | 7 | 13.4 | 10.5 | | 13.1 | 10.4 | | 12.6 | 10.2 | | 11.9 | 9.9 | | 85 |
| 90 | 8.5 | 7.6 | 6.8 | 13 | 10.1 | 7.8 | 12.8 | 10.1 | 7.8 | 12.3 | 9.9 | | 11.6 | 9.7 | | 90 |
| 95 | 8.1 | 7.3 | 6.7 | 12.6 | 9.8 | 7.6 | 12.5 | 9.8 | 7.6 | 12.1 | 9.7 | 7.5 | 11.4 | 9.4 | | 95 |
| 100 | 7.7 | 7 | 6.5 | 12.3 | 9.5 | 7.5 | 12.2 | 9.5 | 7.4 | 11.8 | 9.4 | 7.4 | 11.2 | 9.2 | 7.2 | 100 |
| 105 | 7.3 | 6.8 | 6.4 | 11.9 | 9.2 | 7.3 | 11.9 | 9.3 | 7.3 | 11.5 | 9.1 | 7.2 | 11 | 8.9 | 7.1 | 105 |
| 110 | 7 | 6.6 | 6.3 | 11.5 | 9 | 7.2 | 11.5 | 9 | 7.2 | 11.3 | 8.9 | 7.1 | 10.8 | 8.7 | 7 | 110 |
| 115 | 6.7 | 6.5 | 6.3 | 11.2 | 8.7 | 7.1 | 11.2 | 8.8 | 7.1 | 11 | 8.7 | 7 | 10.6 | 8.5 | 6.9 | 115 |
| 120 | 6.5 | 6.4 | 6.3 | 10.8 | 8.5 | 7 | 10.9 | 8.5 | 6.9 | 10.7 | 8.5 | 6.9 | 10.4 | 8.3 | 6.8 | 120 |
| 125 | 6.2 | 6.3 | 6.3 | 10.5 | 8.2 | 6.9 | 10.6 | 8.3 | 6.8 | 10.4 | 8.3 | 6.8 | 10.1 | 8.1 | 6.7 | 125 |
| 130 | 6 | 6.3 | | 10.1 | 8 | 6.8 | 10.3 | 8.1 | 6.7 | 10.2 | 8.1 | 6.7 | 9.9 | 8 | 6.6 | 130 |
| 135 | | | | 9.8 | 7.8 | 6.7 | 9.9 | 7.9 | 6.7 | 9.9 | 7.9 | 6.6 | 9.7 | 7.8 | 6.6 | 135 |
| 140 | | | | 9.4 | 7.6 | 6.6 | 9.7 | 7.7 | 6.6 | 9.7 | 7.7 | 6.6 | 9.4 | 7.6 | 6.5 | 140 |
| 145 | | | | 9.1 | 7.4 | 6.5 | 9.3 | 7.5 | 6.5 | 9.4 | 7.5 | 6.5 | 9.2 | 7.5 | 6.4 | 145 |
| 150 | | | | 8.8 | 7.3 | 6.5 | 9.1 | 7.4 | 6.4 | 9.1 | 7.4 | 6.4 | 9 | 7.3 | 6.4 | 150 |
| 155 | | | | 8.5 | 7.2 | 6.4 | 8.8 | 7.2 | 6.4 | 8.9 | 7.3 | 6.4 | 8.8 | 7.2 | 6.3 | 155 |
| 160 | | | | 8.3 | 7 | 6.4 | 8.6 | 7.1 | 6.3 | 8.6 | 7.1 | 6.3 | 8.6 | 7 | 6.3 | 160 |
| 165 | | | | 8 | 6.9 | 6.3 | 8.3 | 7 | 6.3 | 8.4 | 7 | 6.2 | 8.4 | 6.9 | 6.2 | 165 |
| 170 | | | | 7.8 | 6.8 | 6.3 | 8.1 | 6.9 | 6.3 | 8.2 | 6.9 | 6.2 | 8.2 | 6.8 | 6.1 | 170 |
| 175 | | | | 7.6 | 6.7 | 6.3 | 7.8 | 6.7 | 6.2 | 8 | 6.8 | 6.2 | 7.9 | 6.7 | 6.1 | 175 |
| 180 | | | | 7.4 | 6.6 | 6.3 | 7.6 | 6.7 | 6.2 | 7.8 | 6.7 | 6.1 | 7.8 | 6.6 | 6.1 | 180 |
| 185 | | | | 7.2 | 6.5 | 6.3 | 7.5 | 6.6 | 6.2 | 7.6 | 6.6 | 6.1 | 7.6 | 6.6 | 6.1 | 185 |
| 190 | | | | 7 | 6.4 | 6.3 | 7.3 | 6.5 | 6.2 | 7.4 | 6.5 | 6.1 | 7.4 | 6.5 | 6 | 190 |
| 195 | | | | 6.8 | 6.4 | 6.3 | 7.1 | 6.4 | 6.2 | 7.2 | 6.4 | 6.1 | 7.3 | 6.4 | 6 | 195 |
| 200 | | | | 6.7 | 6.3 | 6.3 | 7 | 6.4 | 6.2 | 7.1 | 6.4 | 6.1 | 7.1 | 6.4 | 6 | 200 |
| 205 | | | | 6.5 | 6.3 | 6.3 | 6.8 | 6.3 | 6.2 | 7 | 6.3 | 6.1 | 7 | 6.3 | 6 | 205 |
| 210 | | | | 6.4 | 6.3 | 5.4 | 6.7 | 6.3 | 6.2 | 6.8 | 6.3 | 6.1 | 6.9 | 6.2 | 6 | 210 |
| 215 | | | | 6.2 | 6.3 | | 6.6 | 6.2 | 6.2 | 6.7 | 6.2 | 6.1 | 6.8 | 6.2 | 6 | 215 |
| 220 | | | | 6.1 | 6.3 | | 6.4 | 6.2 | 6.2 | 6.6 | 6.2 | 6.1 | 6.7 | 6.1 | 6 | 220 |
| 225 | | | | 5.7 | 6.3 | | 6.3 | 6.2 | 5.1 | 6.5 | 6.2 | 6.1 | 6.6 | 6.1 | 6 | 225 |
| 230 | | | | | | | 6.2 | 6.2 | | 6.4 | 6.2 | 6.1 | 6.5 | 6.1 | 6 | 230 |
| 235 | | | | | | | 6.1 | 6.2 | | 6.3 | 6.2 | 6 | 6.4 | 6.1 | 6 | 235 |
| 240 | | | | | | | 4.1 | 6.2 | | 6.2 | 6.2 | | 6.3 | 6.1 | 6 | 240 |
| 245 | | | | | | | | | | 6.1 | 6.2 | | 6.2 | 6.1 | 6 | 245 |
| 250 | | | | | | | | | | 5.4 | 6.2 | | 6.1 | 6.1 | 5.7 | 250 |
| 255 | | | | | | | | | | 2.6 | 4.9 | | 6 | 6 | | 255 |
| 260 | | | | | | | | | | | | | 5.9 | 6 | | 260 |
| 265 | | | | | | | | | | | | | 4.1 | 6 | | 265 |
| 270 | | | | | | | | | | | | | 3.8 | 3.9 | | 270 |

t_240_002_56501_00_000

Lifting capacities Forces de levage

TNZK

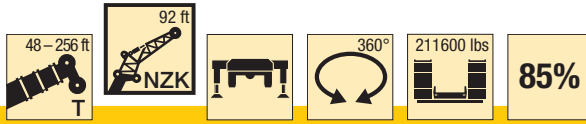

| ft | 208 ft | | | 224 ft | | | 240 ft | | | 253 ft | | | 256 ft | | | ft |
|-----|--------|-----|-----|--------|-----|-----|--------|-----|-----|--------|-----|-----|--------|-----|-----|-----|
| | 92 ft | | | 92 ft | | | 92 ft | | | 92 ft | | | 92 ft | | | |
| | 0° | 20° | 40° | 0° | 20° | 40° | 0° | 20° | 40° | 0° | 20° | 40° | 0° | 20° | 40° | |
| 50 | 11.5 | | | | | | | | | | | | | | | 50 |
| 55 | 11.5 | | | 9.9 | | | | | | | | | | | | 55 |
| 60 | 11.5 | | | 10.1 | | | 8.2 | | | | | | | | | 60 |
| 65 | 11.5 | | | 10.2 | | | 8.5 | | | 6.9 | | | | | | 65 |
| 70 | 11.4 | | | 10.1 | | | 8.7 | | | 7.2 | | | 6.9 | | | 70 |
| 75 | 11.2 | | | 10 | | | 8.7 | | | 7.4 | | | 7.2 | | | 75 |
| 80 | 11.1 | | | 9.9 | | | 8.6 | | | 7.5 | | | 7.3 | | | 80 |
| 85 | 10.9 | 9.4 | | 9.8 | | | 8.5 | | | 7.5 | | | 7.4 | | | 85 |
| 90 | 10.7 | 9.2 | | 9.7 | 8.5 | | 8.4 | | | 7.5 | | | 7.3 | | | 90 |
| 95 | 10.6 | 9 | | 9.6 | 8.4 | | 8.4 | | | 7.4 | | | 7.3 | | | 95 |
| 100 | 10.4 | 8.8 | | 9.4 | 8.2 | | 8.3 | 7.5 | | 7.4 | | | 7.3 | | | 100 |
| 105 | 10.3 | 8.6 | | 9.3 | 8.1 | | 8.2 | 7.4 | | 7.3 | 6.9 | | 7.2 | 6.8 | | 105 |
| 110 | 10.1 | 8.4 | 6.9 | 9.2 | 7.9 | | 8.1 | 7.3 | | 7.3 | 6.8 | | 7.2 | 6.8 | | 110 |
| 115 | 9.9 | 8.2 | 6.8 | 9.1 | 7.7 | 6.6 | 8 | 7.2 | | 7.2 | 6.8 | | 7.1 | 6.7 | | 115 |
| 120 | 9.7 | 8 | 6.7 | 8.9 | 7.6 | 6.5 | 7.9 | 7.1 | 6.2 | 7.2 | 6.7 | | 7 | 6.6 | | 120 |
| 125 | 9.6 | 7.9 | 6.6 | 8.8 | 7.5 | 6.4 | 7.8 | 7 | 6.2 | 7.1 | 6.6 | | 7 | 6.5 | | 125 |
| 130 | 9.4 | 7.7 | 6.5 | 8.7 | 7.3 | 6.3 | 7.7 | 6.9 | 6.1 | 7 | 6.5 | 5.9 | 6.9 | 6.5 | 5.8 | 130 |
| 135 | 9.2 | 7.6 | 6.4 | 8.6 | 7.2 | 6.3 | 7.7 | 6.8 | 6.1 | 7 | 6.4 | 5.9 | 6.9 | 6.4 | 5.8 | 135 |
| 140 | 9 | 7.4 | 6.4 | 8.4 | 7.1 | 6.2 | 7.6 | 6.7 | 6 | 6.9 | 6.4 | 5.8 | 6.8 | 6.3 | 5.8 | 140 |
| 145 | 8.8 | 7.3 | 6.3 | 8.3 | 7 | 6.2 | 7.5 | 6.6 | 6 | 6.8 | 6.3 | 5.8 | 6.7 | 6.2 | 5.8 | 145 |
| 150 | 8.7 | 7.1 | 6.3 | 8.1 | 6.9 | 6.1 | 7.4 | 6.6 | 5.9 | 6.7 | 6.2 | 5.7 | 6.6 | 6.2 | 5.7 | 150 |
| 155 | 8.5 | 7 | 6.2 | 8 | 6.8 | 6.1 | 7.3 | 6.5 | 5.9 | 6.6 | 6.2 | 5.7 | 6.5 | 6.1 | 5.7 | 155 |
| 160 | 8.3 | 6.9 | 6.2 | 7.9 | 6.7 | 6 | 7.2 | 6.4 | 5.9 | 6.5 | 6.1 | 5.7 | 6.4 | 6.1 | 5.7 | 160 |
| 165 | 8.1 | 6.8 | 6.1 | 7.7 | 6.6 | 6 | 7.1 | 6.3 | 5.8 | 6.4 | 6 | 5.7 | 6.4 | 6 | 5.6 | 165 |
| 170 | 7.9 | 6.7 | 6.1 | 7.6 | 6.5 | 5.9 | 7 | 6.3 | 5.8 | 6.3 | 5.9 | 5.6 | 6.2 | 5.9 | 5.6 | 170 |
| 175 | 7.8 | 6.7 | 6 | 7.4 | 6.4 | 5.9 | 6.9 | 6.2 | 5.8 | 6.2 | 5.8 | 5.6 | 6.1 | 5.8 | 5.6 | 175 |
| 180 | 7.6 | 6.6 | 6 | 7.3 | 6.4 | 5.9 | 6.8 | 6.1 | 5.7 | 6 | 5.7 | 5.6 | 6 | 5.7 | 5.6 | 180 |
| 185 | 7.4 | 6.5 | 6 | 7.2 | 6.3 | 5.9 | 6.7 | 6.1 | 5.7 | 5.8 | 5.6 | 5.5 | 5.8 | 5.6 | 5.5 | 185 |
| 190 | 7.3 | 6.4 | 5.9 | 7.1 | 6.2 | 5.8 | 6.6 | 6 | 5.7 | 5.7 | 5.5 | 5.4 | 5.6 | 5.5 | 5.4 | 190 |
| 195 | 7.1 | 6.3 | 5.9 | 7 | 6.2 | 5.8 | 6.5 | 6 | 5.7 | 5.5 | 5.4 | 5.3 | 5.5 | 5.4 | 5.3 | 195 |
| 200 | 7 | 6.3 | 5.9 | 6.8 | 6.1 | 5.8 | 6.3 | 5.9 | 5.7 | 5.3 | 5.3 | 5.3 | 5.3 | 5.3 | 5.2 | 200 |
| 205 | 6.9 | 6.2 | 5.9 | 6.7 | 6.1 | 5.8 | 6.2 | 5.8 | 5.7 | 5.1 | 5.2 | 5.2 | 5.1 | 5.1 | 5.2 | 205 |
| 210 | 6.8 | 6.2 | 5.9 | 6.6 | 6 | 5.8 | 6.1 | 5.7 | 5.7 | 5 | 5 | 5.1 | 4.9 | 5 | 5.1 | 210 |
| 215 | 6.7 | 6.1 | 5.9 | 6.5 | 6 | 5.8 | 5.9 | 5.6 | 5.6 | 4.8 | 4.9 | 5 | 4.8 | 4.9 | 5 | 215 |
| 220 | 6.6 | 6 | 5.9 | 6.5 | 5.9 | 5.8 | 5.8 | 5.5 | 5.6 | 4.6 | 4.8 | 4.9 | 4.6 | 4.7 | 4.9 | 220 |
| 225 | 6.5 | 6 | 5.9 | 6.4 | 5.9 | 5.8 | 5.7 | 5.5 | 5.5 | 4.5 | 4.6 | 4.8 | 4.4 | 4.6 | 4.8 | 225 |
| 230 | 6.4 | 6 | 5.9 | 6.3 | 5.9 | 5.8 | 5.5 | 5.4 | 5.4 | 4.3 | 4.5 | 4.7 | 4.3 | 4.5 | 4.7 | 230 |
| 235 | 6.4 | 6 | 5.9 | 6.2 | 5.8 | 5.8 | 5.4 | 5.3 | 5.4 | 4.1 | 4.3 | 4.6 | 4.1 | 4.3 | 4.6 | 235 |
| 240 | 6.3 | 5.9 | 5.9 | 6 | 5.8 | 5.8 | 5.2 | 5.2 | 5.3 | 4 | 4.2 | 4.5 | 3.9 | 4.1 | 4.4 | 240 |
| 245 | 6.1 | 5.9 | 5.9 | 5.8 | 5.7 | 5.8 | 5.1 | 5.1 | 5.2 | 3.8 | 4 | 4.3 | 3.7 | 4 | 4.3 | 245 |
| 250 | 5.8 | 5.9 | 5.9 | 5.6 | 5.7 | 5.8 | 4.9 | 5 | 5.1 | 3.7 | 3.9 | 4.1 | 3.4 | 3.8 | 4.1 | 250 |
| 255 | 5.4 | 5.8 | 5.9 | 5.3 | 5.6 | 5.8 | 4.7 | 4.9 | 5 | 3.5 | 3.7 | 4 | 3.2 | 3.6 | 4 | 255 |
| 260 | 5.3 | 5.6 | 5.8 | 4.9 | 5.5 | 5.7 | 4.5 | 4.7 | 4.9 | 3.3 | 3.6 | 3.8 | 2.9 | 3.4 | 3.8 | 260 |
| 265 | 5.1 | 5.2 | 5.3 | 4.4 | 5.2 | 5.4 | 4.3 | 4.6 | 4.8 | 3.2 | 3.4 | 3.6 | 2.6 | 3.2 | 3.5 | 265 |
| 270 | 4.9 | 5.1 | | 4.2 | 4.8 | 5 | 4.1 | 4.5 | 4.6 | 3 | 3.3 | 3.5 | 2.4 | 3 | 3.2 | 270 |
| 275 | 4.7 | 4.9 | | 4.1 | 4.2 | 4.4 | 3.7 | 4.3 | 4.4 | 2.7 | 3.1 | 3.3 | | 2.7 | 2.9 | 275 |
| 280 | 3.6 | 4.7 | | 3.9 | 4.1 | 4.2 | 3.2 | 4.1 | 4.2 | | 2.9 | 3.1 | | 2.4 | 2.5 | 280 |
| 285 | | 3.5 | | 3.8 | 4 | | 2.8 | 3.7 | 3.8 | | 2.8 | 3 | | | 2.2 | 285 |
| 290 | | | | 3.6 | 3.8 | | 2.1 | 3.1 | 3.3 | | | 2.7 | | | | 290 |
| 295 | | | | | 3.6 | | | 2.6 | 2.7 | | | | | | | 295 |

t_240_002_56501_00_000

Lifting capacities Forces de levage

TNZK

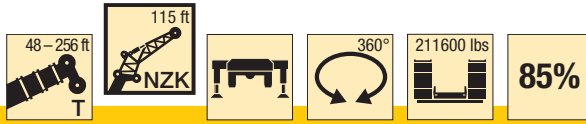

| ft | 48 ft | | | 144 ft | | | 160 ft | | | 176 ft | | | 192 ft | | | ft |
|-----|--------|-----|-----|--------|-----|-----|--------|-----|-----|--------|-----|-----|--------|-----|-----|-----|
| | 115 ft | | | 115 ft | | | 115 ft | | | 115 ft | | | 115 ft | | | |
| | 0° | 20° | 40° | 0° | 20° | 40° | 0° | 20° | 40° | 0° | 20° | 40° | 0° | 20° | 40° | |
| 19 | 9.1 | | | | | | | | | | | | | | | 19 |
| 20 | 9.1 | | | | | | | | | | | | | | | 20 |
| 22 | 9.2 | | | | | | | | | | | | | | | 22 |
| 24 | 10.1 | | | | | | | | | | | | | | | 24 |
| 26 | 10.8 | | | | | | | | | | | | | | | 26 |
| 28 | 11.2 | | | | | | | | | | | | | | | 28 |
| 30 | 11.1 | | | | | | | | | | | | | | | 30 |
| 32 | 10.9 | | | | | | | | | | | | | | | 32 |
| 34 | 10.8 | | | | | | | | | | | | | | | 34 |
| 36 | 10.6 | | | 9.3 | | | | | | | | | | | | 36 |
| 38 | 10.5 | | | 9.7 | | | | | | | | | | | | 38 |
| 40 | 10.3 | | | 10 | | | 9.1 | | | | | | | | | 40 |
| 45 | 9.9 | | | 10.7 | | | 9.8 | | | 8.7 | | | | | | 45 |
| 50 | 9.5 | | | 11 | | | 10.3 | | | 9.2 | | | 7.8 | | | 50 |
| 55 | 9 | | | 10.9 | | | 10.4 | | | 9.6 | | | 8.3 | | | 55 |
| 60 | 8.6 | 7.4 | | 10.7 | | | 10.2 | | | 9.7 | | | 8.7 | | | 60 |
| 65 | 8.2 | 7 | | 10.4 | | | 10 | | | 9.5 | | | 8.8 | | | 65 |
| 70 | 7.7 | 6.6 | | 10.2 | | | 9.8 | | | 9.4 | | | 8.7 | | | 70 |
| 75 | 7.2 | 6.3 | | 9.9 | | | 9.6 | | | 9.2 | | | 8.6 | | | 75 |
| 80 | 6.8 | 6 | | 9.7 | 7.3 | | 9.4 | 7.2 | | 9 | | | 8.4 | | | 80 |
| 85 | 6.5 | 5.7 | | 9.4 | 7.1 | | 9.2 | 7 | | 8.8 | 6.9 | | 8.2 | | | 85 |
| 90 | 6.1 | 5.5 | 4.8 | 9.1 | 6.9 | | 8.9 | 6.8 | | 8.6 | 6.7 | | 8.1 | 6.4 | | 90 |
| 95 | 5.8 | 5.2 | 4.6 | 8.8 | 6.6 | | 8.7 | 6.6 | | 8.4 | 6.5 | | 7.9 | 6.3 | | 95 |
| 100 | 5.6 | 5 | 4.5 | 8.6 | 6.4 | | 8.4 | 6.4 | | 8.2 | 6.3 | | 7.7 | 6.2 | | 100 |
| 105 | 5.3 | 4.8 | 4.3 | 8.3 | 6.2 | 4.6 | 8.2 | 6.2 | | 7.9 | 6.1 | | 7.5 | 6 | | 105 |
| 110 | 5.1 | 4.6 | 4.2 | 8 | 6.1 | 4.5 | 7.9 | 6 | 4.5 | 7.7 | 6 | | 7.4 | 5.8 | | 110 |
| 115 | 4.9 | 4.4 | 4.1 | 7.7 | 5.9 | 4.5 | 7.7 | 5.9 | 4.5 | 7.5 | 5.8 | 4.4 | 7.2 | 5.7 | | 115 |
| 120 | 4.7 | 4.3 | 3.9 | 7.4 | 5.7 | 4.4 | 7.4 | 5.7 | 4.4 | 7.3 | 5.7 | 4.3 | 7 | 5.6 | 4.3 | 120 |
| 125 | 4.5 | 4.1 | 3.9 | 7.1 | 5.6 | 4.4 | 7.2 | 5.6 | 4.3 | 7.1 | 5.5 | 4.3 | 6.8 | 5.4 | 4.2 | 125 |
| 130 | 4.3 | 4 | 3.8 | 6.9 | 5.4 | 4.3 | 6.9 | 5.4 | 4.3 | 6.9 | 5.4 | 4.2 | 6.7 | 5.3 | 4.2 | 130 |
| 135 | 4.2 | 3.9 | 3.8 | 6.6 | 5.3 | 4.2 | 6.7 | 5.3 | 4.2 | 6.7 | 5.3 | 4.2 | 6.5 | 5.2 | 4.1 | 135 |
| 140 | 4 | 3.8 | 3.8 | 6.4 | 5.1 | 4.2 | 6.5 | 5.2 | 4.2 | 6.5 | 5.1 | 4.2 | 6.3 | 5.1 | 4.1 | 140 |
| 145 | 3.9 | 3.8 | 3.8 | 6.2 | 5 | 4.2 | 6.3 | 5 | 4.2 | 6.3 | 5 | 4.1 | 6.2 | 5 | 4 | 145 |
| 150 | 3.8 | 3.8 | | 6 | 4.9 | 4.1 | 6.1 | 4.9 | 4.1 | 6.1 | 4.9 | 4.1 | 6 | 4.8 | 4 | 150 |
| 155 | 3.7 | 3.8 | | 5.8 | 4.8 | 4.1 | 5.9 | 4.8 | 4 | 6 | 4.8 | 4 | 5.9 | 4.7 | 4 | 155 |
| 160 | | | | 5.7 | 4.6 | 4 | 5.8 | 4.7 | 4 | 5.8 | 4.7 | 4 | 5.7 | 4.6 | 3.9 | 160 |
| 165 | | | | 5.5 | 4.6 | 3.9 | 5.6 | 4.6 | 3.9 | 5.7 | 4.6 | 3.9 | 5.6 | 4.6 | 3.9 | 165 |
| 170 | | | | 5.3 | 4.5 | 3.9 | 5.5 | 4.5 | 3.9 | 5.5 | 4.5 | 3.9 | 5.5 | 4.5 | 3.8 | 170 |
| 175 | | | | 5.2 | 4.4 | 3.9 | 5.3 | 4.4 | 3.8 | 5.3 | 4.4 | 3.8 | 5.3 | 4.4 | 3.8 | 175 |
| 180 | | | | 5 | 4.3 | 3.8 | 5.2 | 4.3 | 3.8 | 5.2 | 4.3 | 3.8 | 5.2 | 4.3 | 3.7 | 180 |
| 185 | | | | 4.9 | 4.2 | 3.8 | 5 | 4.2 | 3.8 | 5.1 | 4.3 | 3.7 | 5.1 | 4.2 | 3.7 | 185 |
| 190 | | | | 4.8 | 4.1 | 3.8 | 4.9 | 4.2 | 3.8 | 5 | 4.2 | 3.7 | 4.9 | 4.2 | 3.7 | 190 |
| 195 | | | | 4.7 | 4 | 3.8 | 4.8 | 4.1 | 3.7 | 4.9 | 4.1 | 3.7 | 4.8 | 4.1 | 3.6 | 195 |
| 200 | | | | 4.5 | 4 | 3.8 | 4.7 | 4 | 3.7 | 4.7 | 4 | 3.7 | 4.7 | 4 | 3.6 | 200 |
| 205 | | | | 4.4 | 3.9 | 3.8 | 4.6 | 4 | 3.7 | 4.6 | 4 | 3.6 | 4.6 | 4 | 3.6 | 205 |
| 210 | | | | 4.3 | 3.9 | 3.8 | 4.4 | 3.9 | 3.7 | 4.5 | 3.9 | 3.6 | 4.5 | 3.9 | 3.6 | 210 |
| 215 | | | | 4.2 | 3.8 | 3.8 | 4.3 | 3.9 | 3.7 | 4.4 | 3.9 | 3.6 | 4.4 | 3.8 | 3.6 | 215 |
| 220 | | | | 4.1 | 3.8 | 3.8 | 4.2 | 3.8 | 3.7 | 4.3 | 3.8 | 3.6 | 4.3 | 3.8 | 3.6 | 220 |
| 225 | | | | 4 | 3.8 | 3.8 | 4.2 | 3.8 | 3.7 | 4.3 | 3.8 | 3.6 | 4.2 | 3.8 | 3.6 | 225 |
| 230 | | | | 4 | 3.8 | 3.8 | 4.1 | 3.7 | 3.7 | 4.2 | 3.7 | 3.6 | 4.2 | 3.7 | 3.6 | 230 |
| 235 | | | | 3.9 | 3.8 | | 4 | 3.7 | 3.7 | 4.1 | 3.7 | 3.6 | 4.1 | 3.7 | 3.6 | 235 |
| 240 | | | | 3.8 | 3.8 | | 3.9 | 3.7 | 3.7 | 4 | 3.7 | 3.6 | 4 | 3.6 | 3.6 | 240 |
| 245 | | | | 3.8 | 3.8 | | 3.9 | 3.7 | | 3.9 | 3.7 | 3.6 | 4 | 3.6 | 3.6 | 245 |
| 250 | | | | | | | 3.8 | 3.7 | | 3.9 | 3.6 | 3.6 | 3.9 | 3.6 | 3.6 | 250 |
| 255 | | | | | | | 3.7 | 3.7 | | 3.8 | 3.6 | 3.6 | 3.8 | 3.6 | 3.6 | 255 |
| 260 | | | | | | | 3.7 | 3.7 | | 3.7 | 3.6 | | 3.8 | 3.6 | 3.6 | 260 |
| 265 | | | | | | | | | | 3.7 | 3.6 | | 3.7 | 3.6 | 3.6 | 265 |
| 270 | | | | | | | | | | 3.7 | 3.6 | | 3.7 | 3.6 | 3.6 | 270 |
| 275 | | | | | | | | | | 2.5 | 3.6 | | 3.6 | 3.6 | | 275 |
| 280 | | | | | | | | | | | | | 3.6 | 3.6 | | 280 |
| 285 | | | | | | | | | | | | | 3.3 | 3.6 | | 285 |
| 290 | | | | | | | | | | | | | 2.4 | 3.4 | | 290 |
| 295 | | | | | | | | | | | | | | 2.5 | | 295 |

t_240_002_56601_00_000

Lifting capacities Forces de levage

TNZK

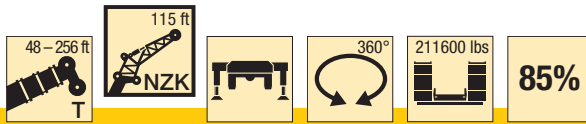

| ft | 208 ft | | | 224 ft | | | 240 ft | | | 253 ft | | | 256 ft | | | ft |
|-----|--------|-----|-----|--------|-----|-----|--------|-----|-----|--------|-----|-----|--------|-----|-----|-----|
| | 115 ft | | | 115 ft | | | 115 ft | | | 115 ft | | | 115 ft | | | |
| | 0° | 20° | 40° | 0° | 20° | 40° | 0° | 20° | 40° | 0° | 20° | 40° | 0° | 20° | 40° | |
| 55 | 6.7 | | | | | | | | | | | | | | | 55 |
| 60 | 7.1 | | | 5.6 | | | | | | | | | | | | 60 |
| 65 | 7.5 | | | 5.9 | | | 4.6 | | | | | | | | | 65 |
| 70 | 7.6 | | | 6.3 | | | 4.8 | | | | | | | | | 70 |
| 75 | 7.7 | | | 6.5 | | | 5.1 | | | 4 | | | 3.8 | | | 75 |
| 80 | 7.6 | | | 6.6 | | | 5.3 | | | 4 | | | 3.8 | | | 80 |
| 85 | 7.5 | | | 6.6 | | | 5.4 | | | 4.1 | | | 3.8 | | | 85 |
| 90 | 7.3 | | | 6.6 | | | 5.5 | | | 4.2 | | | 3.8 | | | 90 |
| 95 | 7.2 | | | 6.6 | | | 5.6 | | | 4.3 | | | 3.8 | | | 95 |
| 100 | 7.1 | 5.9 | | 6.5 | | | 5.6 | | | 4.3 | | | 3.9 | | | 100 |
| 105 | 7 | 5.8 | | 6.4 | 5.4 | | 5.6 | | | 4.3 | | | 3.9 | | | 105 |
| 110 | 6.8 | 5.6 | | 6.3 | 5.3 | | 5.6 | | | 4.3 | | | 3.9 | | | 110 |
| 115 | 6.7 | 5.5 | | 6.2 | 5.2 | | 5.5 | 4.7 | | 4.3 | | | 3.9 | | | 115 |
| 120 | 6.6 | 5.4 | | 6.1 | 5.1 | | 5.5 | 4.7 | | 4.4 | 4.2 | | 3.9 | 4.1 | | 120 |
| 125 | 6.5 | 5.3 | 4.1 | 6 | 5 | | 5.4 | 4.7 | | 4.4 | 4.2 | | 3.9 | 4.1 | | 125 |
| 130 | 6.3 | 5.1 | 4 | 5.9 | 4.9 | | 5.3 | 4.6 | | 4.4 | 4.2 | | 3.9 | 4.1 | | 130 |
| 135 | 6.2 | 5 | 4 | 5.8 | 4.8 | 3.8 | 5.3 | 4.5 | | 4.4 | 4.2 | | 3.9 | 4.1 | | 135 |
| 140 | 6.1 | 4.9 | 4 | 5.6 | 4.7 | 3.8 | 5.2 | 4.4 | 3.6 | 4.4 | 4.1 | | 3.9 | 4 | | 140 |
| 145 | 5.9 | 4.8 | 3.9 | 5.5 | 4.6 | 3.8 | 5.1 | 4.4 | 3.6 | 4.3 | 4.1 | | 3.9 | 4 | | 145 |
| 150 | 5.8 | 4.7 | 3.9 | 5.4 | 4.5 | 3.8 | 5 | 4.3 | 3.6 | 4.3 | 4 | 3.4 | 3.9 | 4 | 3.3 | 150 |
| 155 | 5.7 | 4.6 | 3.9 | 5.3 | 4.4 | 3.7 | 4.9 | 4.2 | 3.6 | 4.2 | 4 | 3.4 | 3.9 | 4 | 3.3 | 155 |
| 160 | 5.5 | 4.5 | 3.8 | 5.2 | 4.4 | 3.7 | 4.8 | 4.1 | 3.5 | 4.2 | 3.9 | 3.4 | 3.9 | 3.9 | 3.3 | 160 |
| 165 | 5.4 | 4.4 | 3.8 | 5.1 | 4.3 | 3.7 | 4.8 | 4.1 | 3.5 | 4.2 | 3.9 | 3.3 | 3.9 | 3.9 | 3.3 | 165 |
| 170 | 5.3 | 4.4 | 3.8 | 5 | 4.2 | 3.6 | 4.7 | 4 | 3.5 | 4.1 | 3.8 | 3.3 | 3.8 | 3.8 | 3.3 | 170 |
| 175 | 5.2 | 4.3 | 3.7 | 4.9 | 4.2 | 3.6 | 4.6 | 4 | 3.5 | 4.1 | 3.8 | 3.3 | 3.8 | 3.8 | 3.3 | 175 |
| 180 | 5 | 4.2 | 3.7 | 4.8 | 4.1 | 3.6 | 4.5 | 3.9 | 3.5 | 4 | 3.7 | 3.3 | 3.7 | 3.7 | 3.3 | 180 |
| 185 | 4.9 | 4.1 | 3.6 | 4.7 | 4 | 3.6 | 4.5 | 3.8 | 3.4 | 4 | 3.7 | 3.3 | 3.7 | 3.7 | 3.3 | 185 |
| 190 | 4.8 | 4.1 | 3.6 | 4.7 | 3.9 | 3.5 | 4.4 | 3.8 | 3.4 | 3.9 | 3.6 | 3.3 | 3.7 | 3.6 | 3.3 | 190 |
| 195 | 4.7 | 4 | 3.6 | 4.6 | 3.9 | 3.5 | 4.3 | 3.7 | 3.4 | 3.9 | 3.6 | 3.3 | 3.6 | 3.6 | 3.3 | 195 |
| 200 | 4.6 | 4 | 3.5 | 4.5 | 3.9 | 3.5 | 4.2 | 3.7 | 3.4 | 3.8 | 3.5 | 3.3 | 3.6 | 3.5 | 3.3 | 200 |
| 205 | 4.5 | 3.9 | 3.5 | 4.4 | 3.8 | 3.5 | 4.2 | 3.6 | 3.4 | 3.7 | 3.5 | 3.3 | 3.6 | 3.5 | 3.2 | 205 |
| 210 | 4.4 | 3.8 | 3.5 | 4.3 | 3.8 | 3.4 | 4.1 | 3.6 | 3.4 | 3.7 | 3.5 | 3.3 | 3.5 | 3.4 | 3.2 | 210 |
| 215 | 4.4 | 3.8 | 3.5 | 4.3 | 3.7 | 3.4 | 4 | 3.6 | 3.3 | 3.6 | 3.4 | 3.2 | 3.5 | 3.4 | 3.2 | 215 |
| 220 | 4.3 | 3.7 | 3.5 | 4.2 | 3.7 | 3.4 | 4 | 3.5 | 3.3 | 3.5 | 3.4 | 3.2 | 3.5 | 3.4 | 3.2 | 220 |
| 225 | 4.2 | 3.7 | 3.5 | 4.1 | 3.6 | 3.4 | 3.9 | 3.5 | 3.3 | 3.4 | 3.3 | 3.2 | 3.3 | 3.4 | 3.2 | 225 |
| 230 | 4.1 | 3.7 | 3.5 | 4 | 3.6 | 3.4 | 3.9 | 3.5 | 3.3 | 3.2 | 3.3 | 3.2 | 3.2 | 3.3 | 3.2 | 230 |
| 235 | 4.1 | 3.6 | 3.5 | 4 | 3.5 | 3.4 | 3.8 | 3.4 | 3.3 | 3.1 | 3.2 | 3.2 | 3.1 | 3.2 | 3.2 | 235 |
| 240 | 4 | 3.6 | 3.5 | 3.9 | 3.5 | 3.4 | 3.8 | 3.4 | 3.3 | 2.9 | 3.1 | 3.2 | 2.9 | 3.1 | 3.2 | 240 |
| 245 | 3.9 | 3.6 | 3.5 | 3.9 | 3.5 | 3.4 | 3.7 | 3.4 | 3.3 | 2.8 | 3 | 3.2 | 2.8 | 3 | 3.2 | 245 |
| 250 | 3.9 | 3.5 | 3.5 | 3.8 | 3.4 | 3.4 | 3.6 | 3.4 | 3.3 | 2.6 | 2.9 | 3.1 | 2.6 | 2.9 | 3.1 | 250 |
| 255 | 3.8 | 3.5 | 3.5 | 3.7 | 3.4 | 3.4 | 3.5 | 3.3 | 3.3 | 2.5 | 2.8 | 3.1 | 2.5 | 2.8 | 3 | 255 |
| 260 | 3.8 | 3.5 | 3.5 | 3.7 | 3.4 | 3.4 | 3.5 | 3.3 | 3.3 | 2.3 | 2.7 | 3 | 2.3 | 2.6 | 3 | 260 |
| 265 | 3.7 | 3.5 | 3.5 | 3.6 | 3.4 | 3.4 | 3.4 | 3.3 | 3.3 | 2.2 | 2.5 | 2.8 | | 2.5 | 2.8 | 265 |
| 270 | 3.7 | 3.5 | 3.5 | 3.5 | 3.4 | 3.4 | 3.3 | 3.3 | 3.3 | | 2.4 | 2.7 | | 2.4 | 2.7 | 270 |
| 275 | 3.6 | 3.5 | 3.5 | 3.4 | 3.4 | 3.4 | 3.2 | 3.2 | 3.3 | | 2.2 | 2.5 | | 2.2 | 2.5 | 275 |
| 280 | 3.5 | 3.5 | 3.5 | 3.2 | 3.3 | 3.4 | 3 | 3.1 | 3.3 | | | 2.4 | | | 2.4 | 280 |
| 285 | 3.5 | 3.5 | | 2.9 | 3.3 | 3.4 | | 3.1 | 3.3 | | | 2.2 | | | | 285 |
| 290 | 3.5 | 3.5 | | 2.8 | 3.2 | 3.4 | | 3 | 3.3 | | | | | | | 290 |
| 295 | 3.3 | 3.5 | | 2.6 | 2.8 | 3.2 | | 2.8 | 3.1 | | | | | | | 295 |
| 300 | 2.2 | 3.4 | | 2.5 | 2.7 | | | | 2.7 | | | | | | | 300 |
| 305 | | 2.6 | | | 2.6 | | | | | | | | | | | 305 |
| 310 | | | | | 2.4 | | | | | | | | | | | 310 |

t_240_002_56601_00_000

Lifting heights Hauteurs de levage

TNZK

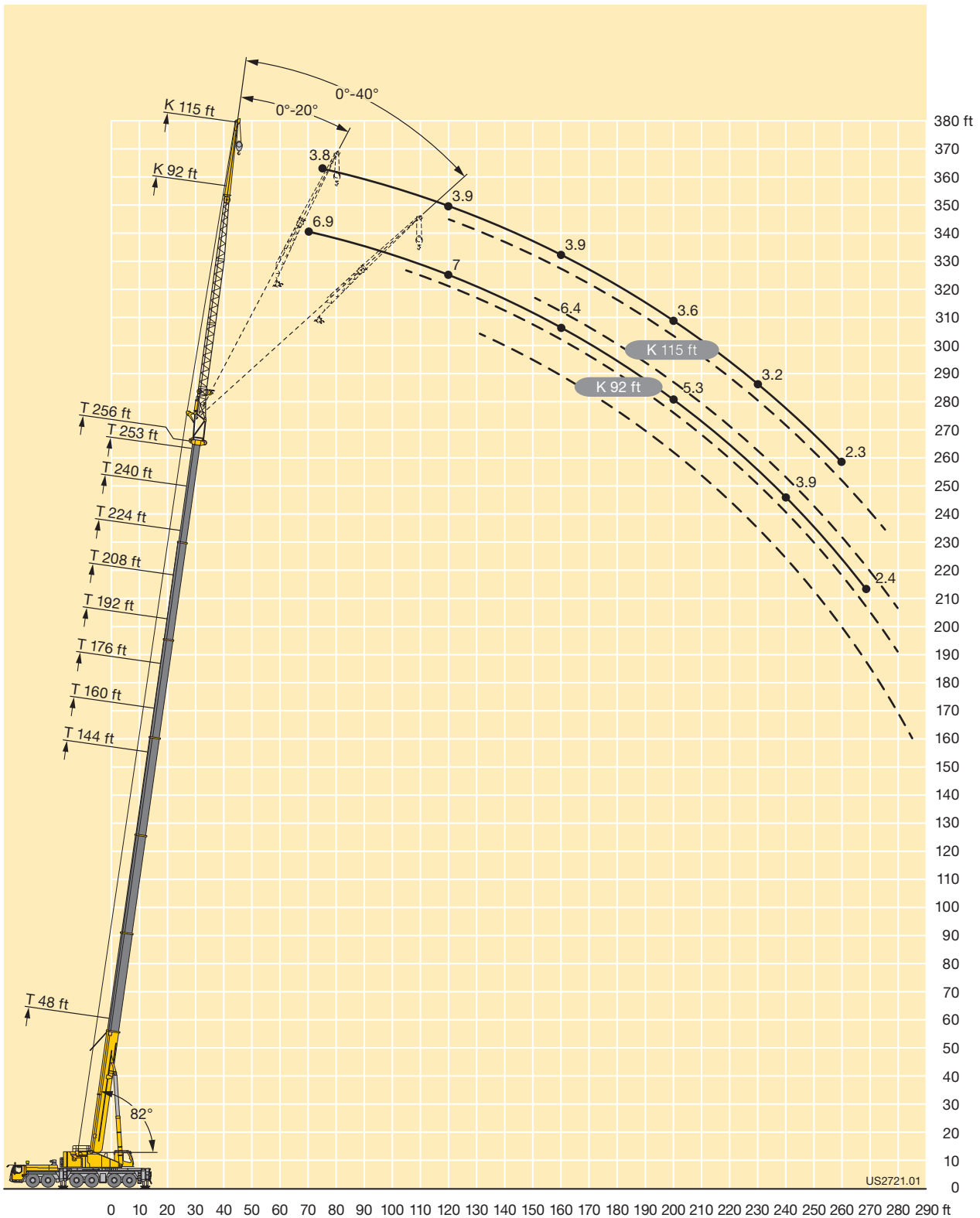

Lifting capacities Forces de levage

TF

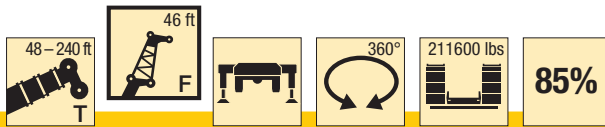

| ft | 48 + 6.6 ft* | | | 144 + 6.6 ft* | | | 160 + 6.6 ft* | | | 176 + 6.6 ft* | | | 192 + 6.6 ft* | | | 208 + 6.6 ft* | | | 224 + 6.6 ft* | | | 240 + 6.6 ft* | | | ft |
|-----|--------------|------|------|---------------|------|------|---------------|------|------|---------------|------|------|---------------|------|------|---------------|------|------|---------------|------|------|---------------|------|------|-----|
| | 46 ft | | | 46 ft | | | 46 ft | | | 46 ft | | | 46 ft | | | 46 ft | | | 46 ft | | | 46 ft | | | |
| | 0° | 20° | 40° | 0° | 20° | 40° | 0° | 20° | 40° | 0° | 20° | 40° | 0° | 20° | 40° | 0° | 20° | 40° | 0° | 20° | 40° | 0° | 20° | 40° | |
| 12 | 53.6 | | | | | | | | | | | | | | | | | | | | | | | 12 | |
| 13 | 53.6 | | | | | | | | | | | | | | | | | | | | | | | 13 | |
| 14 | 53.1 | | | | | | | | | | | | | | | | | | | | | | | 14 | |
| 15 | 52.4 | | | | | | | | | | | | | | | | | | | | | | | 15 | |
| 16 | 51.8 | | | | | | | | | | | | | | | | | | | | | | | 16 | |
| 17 | 51 | | | | | | | | | | | | | | | | | | | | | | | 17 | |
| 18 | 49.9 | | | | | | | | | | | | | | | | | | | | | | | 18 | |
| 19 | 48.8 | | | | | | | | | | | | | | | | | | | | | | | 19 | |
| 20 | 47.7 | | | | | | | | | | | | | | | | | | | | | | | 20 | |
| 22 | 45.8 | | | | | | | | | | | | | | | | | | | | | | | 22 | |
| 24 | 43.9 | | | | | | | | | | | | | | | | | | | | | | | 24 | |
| 26 | 42.2 | | | | | | | | | | | | | | | | | | | | | | | 26 | |
| 28 | 40.5 | 36.1 | | | | | | | | | | | | | | | | | | | | | | 28 | |
| 30 | 38.8 | 35.5 | | 53.6 | | | | | | | | | | | | | | | | | | | | 30 | |
| 32 | 37.3 | 34.1 | | 52.9 | | | | | | | | | | | | | | | | | | | | 32 | |
| 34 | 35.8 | 32.8 | | 52.2 | | | | | | | | | | | | | | | | | | | | 34 | |
| 36 | 34.3 | 31.6 | | 51.6 | | | 47.7 | | | | | | | | | | | | | | | | | 36 | |
| 38 | 32.9 | 30.5 | | 50.6 | | | 47.2 | | | | | | | | | | | | | | | | | 38 | |
| 40 | 31.7 | 29.4 | 27 | 49.5 | | | 46.6 | | | 41.5 | | | | | | | | | | | | | | 40 | |
| 45 | 28.8 | 27.1 | 26.7 | 46.8 | | | 44.8 | | | 40.8 | | | 35.1 | | | | | | | | | | | 45 | |
| 50 | 26.5 | 24.9 | 24.8 | 44.3 | 34.9 | | 42.7 | | | 39.7 | | | 34.7 | | 29.3 | | | | | | | | | 50 | |
| 55 | 24.4 | 23.2 | 23.2 | 42.1 | 33.2 | | 40.8 | 32.9 | | 38.4 | | | 34.3 | | 29.1 | | 23.4 | | | | | | | 55 | |
| 60 | 22.6 | 21.6 | 21.7 | 39.9 | 31.7 | 27 | 39.1 | 31.4 | | 37.1 | 30.5 | | 33.7 | | 28.9 | | 23.1 | | | | 18.5 | | | 60 | |
| 65 | 21 | 20.2 | 20.4 | 38 | 30.4 | 26.8 | 37.4 | 30.2 | 26.7 | 35.7 | 29.4 | | 33 | 27.9 | 28.5 | | 22.9 | | | | 18.3 | | | 65 | |
| 70 | 19.7 | 19 | 19.4 | 36 | 29 | 26 | 35.7 | 29 | 25.9 | 34.3 | 28.3 | 25.3 | 31.9 | 27 | 28 | 24.9 | 22.6 | | | | 18 | | | 70 | |
| 75 | 18.4 | 17.9 | 18.4 | 34.1 | 27.9 | 25.2 | 34.2 | 27.9 | 25 | 33 | 27.3 | 24.6 | 30.9 | 26.2 | 23.6 | 27.2 | 24.3 | 22.3 | 20.9 | | 17.7 | | | 75 | |
| 80 | 17.4 | 17 | 17.6 | 32.4 | 26.8 | 24.4 | 32.7 | 26.9 | 24.3 | 31.8 | 26.4 | 23.9 | 29.9 | 25.4 | 23 | 26.4 | 23.7 | | | | 17.4 | 15.7 | | 80 | |
| 85 | 16.5 | 16.3 | 17.1 | 30.9 | 25.7 | 23.6 | 31.2 | 25.9 | 23.6 | 30.6 | 25.5 | 23.2 | 28.9 | 24.6 | 22.4 | 25.5 | 23.1 | 21.2 | 21.2 | 19.9 | 17 | 15.3 | | 85 | |
| 90 | 15.8 | 15.8 | | 29.5 | 24.8 | 22.9 | 29.8 | 25 | 22.9 | 29.4 | 24.7 | 22.6 | 28 | 23.9 | 21.9 | 24.7 | 22.5 | 20.8 | 20.5 | 19.3 | 18.9 | 16.6 | 14.9 | 90 | |
| 95 | | | | 28.1 | 23.9 | 22.3 | 28.7 | 24.2 | 22.3 | 28.2 | 24 | 22.1 | 27.1 | 23.2 | 21.4 | 23.9 | 22 | 20.4 | 19.9 | 18.7 | 18.4 | 16.1 | 14.5 | 13.9 | 95 |
| 100 | | | | 27 | 23 | 21.7 | 27.5 | 23.4 | 21.8 | 27.2 | 23.2 | 21.5 | 26.3 | 22.6 | 20.9 | 23.1 | 21.5 | 20 | 19.2 | 18.2 | 17.8 | 15.7 | 14.1 | 13.5 | 100 |
| 105 | | | | 25.9 | 22.3 | 21.1 | 26.4 | 22.6 | 21.2 | 26.3 | 22.5 | 21 | 25.4 | 22 | 20.5 | 22.3 | 20.9 | 19.6 | 18.6 | 17.7 | 17.3 | 15.2 | 13.7 | 13.1 | 105 |
| 110 | | | | 24.8 | 21.6 | 20.5 | 25.4 | 21.9 | 20.7 | 25.4 | 21.9 | 20.6 | 24.6 | 21.4 | 20.1 | 21.5 | 20.3 | 19.2 | 18 | 17.2 | 16.8 | 14.8 | 13.3 | 12.8 | 110 |
| 115 | | | | 23.8 | 20.9 | 20 | 24.5 | 21.3 | 20.2 | 24.5 | 21.3 | 20.1 | 23.9 | 20.9 | 19.7 | 20.8 | 19.7 | 18.9 | 17.4 | 16.6 | 16.4 | 14.3 | 12.9 | 12.5 | 115 |
| 120 | | | | 22.9 | 20.3 | 19.6 | 23.6 | 20.7 | 19.8 | 23.7 | 20.7 | 19.7 | 23.2 | 20.4 | 19.3 | 20.1 | 19 | 18.5 | 16.9 | 16.1 | 15.9 | 13.9 | 12.6 | 12.2 | 120 |
| 125 | | | | 22.1 | 19.7 | 19.2 | 22.8 | 20.1 | 19.4 | 23 | 20.2 | 19.3 | 22.5 | 19.9 | 19 | 19.4 | 18.4 | 18.1 | 16.3 | 15.6 | 15.5 | 13.5 | 12.3 | 11.9 | 125 |
| 130 | | | | 21.2 | 19.1 | 18.8 | 22 | 19.6 | 19 | 22.3 | 19.7 | 19 | 21.8 | 19.4 | 18.6 | 18.7 | 17.8 | 17.7 | 15.7 | 15.1 | 15.1 | 13.1 | 12 | 11.6 | 130 |
| 135 | | | | 20.5 | 18.6 | 18.4 | 21.3 | 19.1 | 18.6 | 21.6 | 19.2 | 18.6 | 21 | 19 | 18.3 | 18.1 | 17.2 | 17.2 | 15.2 | 14.6 | 14.6 | 12.8 | 11.6 | 11.3 | 135 |
| 140 | | | | 19.9 | 18.1 | 18.1 | 20.6 | 18.6 | 18.3 | 20.9 | 18.8 | 18.3 | 20.1 | 18.6 | 18 | 17.4 | 16.7 | 16.7 | 14.6 | 14.1 | 14.2 | 12.4 | 11.3 | 11.1 | 140 |
| 145 | | | | 19.2 | 17.7 | 17.8 | 20 | 18.2 | 18 | 20.3 | 18.4 | 18 | 19.2 | 18.2 | 17.7 | 16.8 | 16.2 | 16.2 | 14.1 | 13.6 | 13.7 | 12 | 11 | 10.8 | 145 |
| 150 | | | | 18.6 | 17.3 | 17.5 | 19.4 | 17.8 | 17.7 | 19.8 | 18 | 17.7 | 18.3 | 17.9 | 17.5 | 16.2 | 15.7 | 15.7 | 13.6 | 13.2 | 13.3 | 11.6 | 10.8 | 10.6 | 150 |
| 155 | | | | 18 | 16.9 | 17.3 | 18.9 | 17.4 | 17.5 | 19.2 | 17.6 | 17.5 | 17.5 | 17.3 | 17.3 | 15.6 | 15.2 | 15.2 | 13.2 | 12.8 | 12.9 | 11.2 | 10.5 | 10.3 | 155 |
| 160 | | | | 17.5 | 16.6 | 17.1 | 18.4 | 17 | 17.2 | 18.6 | 17.2 | 17.2 | 16.7 | 16.8 | 17 | 14.9 | 14.7 | 14.7 | 12.7 | 12.4 | 12.5 | 10.8 | 10.2 | 10.1 | 160 |
| 165 | | | | 17 | 16.3 | 17.1 | 17.8 | 16.7 | 17.1 | 17.9 | 16.9 | 17 | 15.9 | 16.3 | 16.7 | 14.3 | 14.2 | 14.3 | 12.3 | 12 | 12.1 | 10.5 | 10 | 9.9 | 165 |
| 170 | | | | 16.6 | 16 | | 17.4 | 16.4 | 17 | 16.7 | 16.6 | 16.9 | 15.2 | 15.7 | 16.1 | 13.7 | 13.8 | 13.9 | 11.9 | 11.5 | 11.7 | 10.1 | 9.7 | 9.7 | 170 |
| 175 | | | | 16.2 | 15.9 | | 16.9 | 16.1 | 16.9 | 15.5 | 16.2 | 16.7 | 14.4 | 15 | 15.4 | 13.1 | 13.4 | 13.5 | 11.4 | 11.2 | 11.3 | 9.8 | 9.5 | 9.5 | 175 |
| 180 | | | | 15.8 | 15.8 | | 16.1 | 15.9 | 16.7 | 14.6 | 15.3 | 15.9 | 13.8 | 14.3 | 14.7 | 12.5 | 12.9 | 13 | 11 | 10.8 | 11 | 9.4 | 9.2 | 9.3 | 180 |
| 185 | | | | 10.9 | 13.1 | | 15 | 15.6 | | 14 | 14.2 | 14.7 | 13 | 13.6 | 14 | 11.8 | 12.4 | 12.6 | 10.6 | 10.5 | 10.6 | 9.1 | 8.9 | 9.1 | 185 |
| 190 | | | | | | | 14.1 | 14.5 | | 13.5 | 13.7 | 13.9 | 12.1 | 12.9 | 13.3 | 11.3 | 11.8 | 12.1 | 10.2 | 10.1 | 10.3 | 8.7 | 8.7 | 8.8 | 190 |
| 195 | | | | | | | 12.5 | 13.5 | | 12.7 | 13.1 | 13.3 | 11.2 | 12 | 12.5 | 10.7 | 11.3 | 11.5 | 9.7 | 9.8 | 10 | 8.4 | 8.4 | 8.5 | 195 |
| 200 | | | | | | | 8 | 9.9 | | 11.9 | 12.4 | | 10.6 | 11 | 11.5 | 10.2 | 10.7 | 11 | 9.3 | 9.5 | 9.7 | 8.2 | 8.1 | 8.3 | 200 |
| 205 | | | | | | | | | | 11 | 11.5 | | 10.2 | 10.3 | 10.5 | 9.5 | 10.2 | 10.4 | 8.9 | 9.1 | 9.3 | 7.9 | 7.8 | 8 | 205 |
| 210 | | | | | | | | | | 9.8 | 10.6 | | 9.8 | 9.9 | | 8.8 | 9.6 | 9.8 | 8.5 | 8.8 | 9 | 7.6 | 7.6 | 7.7 | 210 |
| 215 | | | | | | | | | | 6.1 | 7.6 | | 9.4 | 9.5 | | 8.2 | 8.9 | 9.1 | 8 | 8.5 | 8.6 | 7.4 | 7.4 | 7.5 | 215 |
| 220 | | | | | | | | | | | | | 8.8 | 9.2 | | 7.9 | 8.1 | 8.2 | 7.6 | 8.1 | 8.2 | 7.1 | 7.2 | 7.3 | 220 |
| 225 | | | | | | | | | | | | | 7.6 | 8.5 | | 7.6 | 7.7 | | 7.1 | 7.6 | 7.8 | 6.8 | 7 | 7.1 | 225 |
| 230 | | | | | | | | | | | | | 5.8 | 6.2 | | 7.2 | 7.4 | | 6.5 | 7.2 | 7.3 | 6.5 | 6.7 | 6.9 | 230 |
| 235 | | | | | | | | | | | | | | | | 7 | 7.1 | | 6.3 | 6.6 | 6.7 | 6.2 | 6.5 | 6.7 | 235 |
| 240 | | | | | | | | | | | | | | | | 6.2 | 6.9 | | 6.1 | 6.2 | | 5.8 | 6.2 | 6.4 | 240 |
| 245 | | | | | | | | | | | | | | | | 5.2 | 5.4 | | 5.8 | 6 | | 5.3 | 6 | 6.1 | 245 |
| 250 | | | | | | | | | | | | | | | | | | 5.6 | 5.8 | | | 4.7 | 5.5 | | 250 |
| 255 | | | | | | | | | | | | | | | | | | 5.1 | 5.6 | | | 4.1 | 4.9 | | 255 |
| 260 | | | | | | | | | | | | | | | | | | | 4.2 | | | 3.6 | 4.2 | | 260 |
| 265 | | | | | | | | | | | | | | | | | | | | | | 3.6 | | | 265 |
| 270 | | | | | | | | | | | | | | | | | | | | | | 3 | | | 270 |

* adapter · pièce d'adaptateur

t_240_003_50101_00_000 / 52101_00_000 / 54101_00_000

Lifting capacities Forces de levage

TF



| ft | 48 + 6.6 ft* | | | 144 + 6.6 ft* | | | 160 + 6.6 ft* | | | 176 + 6.6 ft* | | | 192 + 6.6 ft* | | | 208 + 6.6 ft* | | | 224 + 6.6 ft* | | | 240 + 6.6 ft* | | | ft |
|-----|--------------|------|------|---------------|------|------|---------------|------|------|---------------|------|------|---------------|------|------|---------------|------|------|---------------|------|------|---------------|------|------|-----|
| | 57 ft | | | 57 ft | | | 57 ft | | | 57 ft | | | 57 ft | | | 57 ft | | | 57 ft | | | | | | |
| | 0° | 20° | 40° | 0° | 20° | 40° | 0° | 20° | 40° | 0° | 20° | 40° | 0° | 20° | 40° | 0° | 20° | 40° | 0° | 20° | 40° | 0° | 20° | 40° | |
| 13 | 45.8 | | | | | | | | | | | | | | | | | | | | | | | 13 | |
| 14 | 45.8 | | | | | | | | | | | | | | | | | | | | | | | 14 | |
| 15 | 45.8 | | | | | | | | | | | | | | | | | | | | | | | 15 | |
| 16 | 45.2 | | | | | | | | | | | | | | | | | | | | | | | 16 | |
| 17 | 44.6 | | | | | | | | | | | | | | | | | | | | | | | 17 | |
| 18 | 43.8 | | | | | | | | | | | | | | | | | | | | | | | 18 | |
| 19 | 43 | | | | | | | | | | | | | | | | | | | | | | | 19 | |
| 20 | 42.2 | | | | | | | | | | | | | | | | | | | | | | | 20 | |
| 22 | 40.6 | | | | | | | | | | | | | | | | | | | | | | | 22 | |
| 24 | 39 | | | | | | | | | | | | | | | | | | | | | | | 24 | |
| 26 | 37.5 | | | | | | | | | | | | | | | | | | | | | | | 26 | |
| 28 | 36.1 | | | | | | | | | | | | | | | | | | | | | | | 28 | |
| 30 | 34.8 | | | | | | | | | | | | | | | | | | | | | | | 30 | |
| 32 | 33.6 | | | | | | | | | | | | | | | | | | | | | | | 32 | |
| 34 | 32.3 | 27 | | 45 | | | | | | | | | | | | | | | | | | | | 34 | |
| 36 | 31.2 | 27 | | 44.3 | | | | | | | | | | | | | | | | | | | | 36 | |
| 38 | 30 | 27 | | 43.4 | | | 40.4 | | | | | | | | | | | | | | | | | 38 | |
| 40 | 28.9 | 26.9 | | 42.5 | | | 39.9 | | | | | | | | | | | | | | | | | 40 | |
| 45 | 26.3 | 25.4 | | 40.3 | | | 38.5 | | | 35 | | | | | | | | | | | | | | 45 | |
| 50 | 24.1 | 23.4 | 21.6 | 38.2 | | | 36.8 | | | 34.2 | | | 29.9 | | | 24.4 | | | | | | | | 50 | |
| 55 | 22.3 | 21.7 | 20.5 | 36.3 | 27 | | 35.2 | | | 33.1 | | | 29.4 | | | 24.3 | | | 19.6 | | | | | 55 | |
| 60 | 20.6 | 20.2 | 19.4 | 34.6 | 27 | | 33.7 | 27 | | 31.9 | | | 28.9 | | | 24.1 | | | 19.5 | | | 15.5 | | 60 | |
| 65 | 19.1 | 18.8 | 18.3 | 32.9 | 26.7 | | 32.3 | 26.5 | | 30.8 | 25.7 | | 28.3 | | | 23.9 | | | 19.4 | | | 15.4 | | 65 | |
| 70 | 17.8 | 17.6 | 17.2 | 31.3 | 25.7 | 21.4 | 30.9 | 25.5 | | 29.7 | 24.7 | | 27.6 | 23.3 | | 23.7 | | | 19.3 | | | 15.3 | | 70 | |
| 75 | 16.7 | 16.6 | 16.3 | 29.8 | 24.7 | 20.8 | 29.7 | 24.5 | 20.6 | 28.6 | 23.9 | | 26.8 | 22.6 | | 23.5 | 20.9 | | 19 | | | 15.1 | | 75 | |
| 80 | 15.7 | 15.7 | 15.5 | 28.3 | 23.7 | 20.2 | 28.4 | 23.6 | 20.1 | 27.6 | 23 | 19.8 | 25.9 | 22 | | 23.2 | 20.3 | | 18.8 | 14.5 | | 14.8 | | 80 | |
| 85 | 14.7 | 14.9 | 14.8 | 26.9 | 22.8 | 19.7 | 27.2 | 22.7 | 19.6 | 26.5 | 22.3 | 19.4 | 25.1 | 21.3 | 18.8 | 22.7 | 19.8 | | 18.4 | 17.9 | | 14.6 | | 85 | |
| 90 | 14 | 14.1 | 14.2 | 25.7 | 21.9 | 19.2 | 25.9 | 21.9 | 19.2 | 25.5 | 21.5 | 18.9 | 24.2 | 20.7 | 18.4 | 22 | 19.3 | 17.4 | 18.1 | 17.4 | | 14.2 | 13.1 | 90 | |
| 95 | 13.3 | 13.5 | 13.8 | 24.5 | 21.1 | 18.6 | 24.8 | 21.2 | 18.7 | 24.6 | 20.9 | 18.4 | 23.5 | 20.1 | 17.9 | 21.4 | 18.8 | 17.1 | 17.6 | 16.9 | 12.4 | 13.8 | 12.8 | 95 | |
| 100 | 12.7 | 13 | 4.5 | 23.4 | 20.3 | 18.1 | 23.8 | 20.5 | 18.2 | 23.6 | 20.2 | 18 | 22.7 | 19.5 | 17.5 | 20.7 | 18.4 | 16.7 | 17.1 | 16.5 | 15.7 | 13.4 | 12.4 | 100 | |
| 105 | 12.4 | | | 22.4 | 19.6 | 17.6 | 22.9 | 19.8 | 17.7 | 22.8 | 19.6 | 17.5 | 22 | 19 | 17.1 | 20.1 | 17.9 | 16.4 | 16.6 | 16 | 15.4 | 13.1 | 12 | 11.5 | 105 |
| 110 | | | | 21.5 | 19 | 17.2 | 22 | 19.2 | 17.3 | 22 | 19 | 17.1 | 21.3 | 18.5 | 16.8 | 19.4 | 17.5 | 16.1 | 16.1 | 15.5 | 15.1 | 12.7 | 11.7 | 11.2 | 110 |
| 115 | | | | 20.7 | 18.3 | 16.7 | 21.2 | 18.6 | 16.9 | 21.2 | 18.5 | 16.8 | 20.6 | 18 | 16.4 | 18.8 | 17.1 | 15.8 | 15.6 | 15.1 | 14.8 | 12.3 | 11.4 | 10.9 | 115 |
| 120 | | | | 19.8 | 17.7 | 16.3 | 20.4 | 18 | 16.5 | 20.5 | 18 | 16.4 | 20 | 17.6 | 16.1 | 18.1 | 16.7 | 15.5 | 15.1 | 14.6 | 14.4 | 12 | 11.1 | 10.6 | 120 |
| 125 | | | | 19 | 17.2 | 15.9 | 19.7 | 17.5 | 16.1 | 19.8 | 17.5 | 16.1 | 19.4 | 17.1 | 15.8 | 17.5 | 16.4 | 15.2 | 14.6 | 14.2 | 14 | 11.7 | 10.7 | 10.3 | 125 |
| 130 | | | | 18.4 | 16.7 | 15.6 | 19 | 17 | 15.8 | 19.2 | 17.1 | 15.7 | 18.8 | 16.7 | 15.5 | 16.9 | 16 | 15 | 14.1 | 13.8 | 13.6 | 11.3 | 10.5 | 10.1 | 130 |
| 135 | | | | 17.7 | 16.2 | 15.2 | 18.3 | 16.5 | 15.4 | 18.6 | 16.6 | 15.4 | 18.3 | 16.3 | 15.2 | 16.4 | 15.6 | 14.7 | 13.7 | 13.4 | 13.2 | 11 | 10.2 | 9.8 | 135 |
| 140 | | | | 17 | 15.8 | 15 | 17.7 | 16.1 | 15.1 | 18 | 16.2 | 15.1 | 17.7 | 15.9 | 14.9 | 15.8 | 15.2 | 14.5 | 13.2 | 13 | 12.9 | 10.7 | 9.9 | 9.6 | 140 |
| 145 | | | | 16.5 | 15.4 | 14.7 | 17.2 | 15.7 | 14.9 | 17.4 | 15.8 | 14.9 | 17.3 | 15.6 | 14.7 | 15.3 | 14.8 | 14.3 | 12.7 | 12.6 | 12.6 | 10.4 | 9.6 | 9.4 | 145 |
| 150 | | | | 16 | 15 | 14.4 | 16.6 | 15.3 | 14.6 | 16.8 | 15.4 | 14.6 | 16.8 | 15.3 | 14.4 | 14.8 | 14.4 | 14.1 | 12.3 | 12.2 | 12.2 | 10.1 | 9.4 | 9.1 | 150 |
| 155 | | | | 15.4 | 14.6 | 14.2 | 16.1 | 15 | 14.4 | 16.4 | 15.1 | 14.4 | 16.3 | 14.9 | 14.2 | 14.3 | 14 | 13.9 | 11.9 | 11.8 | 11.9 | 9.8 | 9.1 | 8.9 | 155 |
| 160 | | | | 14.9 | 14.2 | 14 | 15.6 | 14.6 | 14.2 | 16 | 14.8 | 14.2 | 15.9 | 14.6 | 14.1 | 13.9 | 13.6 | 13.6 | 11.5 | 11.4 | 11.5 | 9.5 | 8.9 | 8.7 | 160 |
| 165 | | | | 14.5 | 13.9 | 13.9 | 15.2 | 14.3 | 14 | 15.5 | 14.5 | 14 | 15.3 | 14.4 | 13.9 | 13.4 | 13.1 | 13.2 | 11.1 | 11 | 11.2 | 9.3 | 8.7 | 8.5 | 165 |
| 170 | | | | 14.1 | 13.6 | 13.8 | 14.8 | 14 | 13.8 | 15.1 | 14.2 | 13.8 | 14.7 | 14.1 | 13.7 | 12.9 | 12.7 | 12.8 | 10.7 | 10.7 | 10.8 | 9 | 8.5 | 8.3 | 170 |
| 175 | | | | 13.7 | 13.4 | 13.7 | 14.4 | 13.7 | 13.7 | 14.7 | 13.9 | 13.7 | 14 | 13.8 | 13.5 | 12.5 | 12.3 | 12.4 | 10.4 | 10.3 | 10.5 | 8.7 | 8.3 | 8.2 | 175 |
| 180 | | | | 13.3 | 13.1 | | 14 | 13.5 | 13.6 | 14.3 | 13.7 | 13.6 | 13.4 | 13.5 | 13.4 | 12 | 12 | 12.1 | 10 | 10 | 10.1 | 8.5 | 8.1 | 8 | 180 |
| 185 | | | | 13 | 13 | | 13.6 | 13.2 | 13.6 | 13.8 | 13.4 | 13.5 | 12.7 | 13 | 13.3 | 11.5 | 11.6 | 11.7 | 9.7 | 9.6 | 9.8 | 8.2 | 7.9 | 7.8 | 185 |
| 190 | | | | 12.7 | 12.9 | | 13.3 | 13.1 | 13.5 | 12.8 | 13.2 | 13.4 | 12.1 | 12.6 | 13.2 | 11 | 11.2 | 11.4 | 9.3 | 9.3 | 9.5 | 7.9 | 7.7 | 7.7 | 190 |
| 195 | | | | 10.9 | 12.8 | | 13 | 12.9 | | 12.3 | 12.9 | 13.2 | 11.5 | 12.1 | 12.6 | 10.5 | 10.8 | 11 | 9 | 9 | 9.2 | 7.6 | 7.5 | 7.5 | 195 |
| 200 | | | | | | | 12.6 | 12.7 | | 11.8 | 12 | 12.3 | 10.6 | 11.6 | 11.9 | 10 | 10.4 | 10.7 | 8.7 | 8.7 | 8.9 | 7.4 | 7.3 | 7.4 | 200 |
| 205 | | | | | | | 11.6 | 12.4 | | 11.3 | 11.6 | 11.8 | 9.8 | 10.9 | 11.3 | 9.5 | 9.9 | 10.2 | 8.4 | 8.4 | 8.6 | 7.1 | 7.1 | 7.2 | 205 |
| 210 | | | | | | | 7.9 | 10.3 | | 10.6 | 11.1 | | 9.2 | 10.1 | 10.4 | 9 | 9.5 | 9.8 | 8.1 | 8.1 | 8.3 | 6.9 | 7 | 7.1 | 210 |
| 215 | | | | | | | | | | 9.8 | 10.5 | | 8.8 | 9.3 | 9.5 | 8.5 | 9 | 9.2 | 7.8 | 7.9 | 8.1 | 6.7 | 6.8 | 6.9 | 215 |
| 220 | | | | | | | | | | 8.8 | 9.7 | | 8.4 | 8.7 | 8.8 | 7.8 | 8.5 | 8.7 | 7.4 | 7.6 | 7.8 | 6.5 | 6.6 | 6.8 | 220 |
| 225 | | | | | | | | | | 5.9 | 7.8 | | 8.1 | 8.3 | | 7.2 | 7.9 | 8.1 | 7.1 | 7.3 | 7.5 | 6.3 | 6.4 | 6.5 | 225 |
| 230 | | | | | | | | | | | | | 7.7 | 8 | | 6.8 | 7.2 | 7.4 | 6.8 | 7 | 7.2 | 6.1 | 6.2 | 6.4 | 230 |
| 235 | | | | | | | | | | | | | 7 | 7.6 | | 6.6 | 6.7 | | 6.4 | 6.7 | 6.9 | 5.8 | 6 | 6.2 | 235 |
| 240 | | | | | | | | | | | | | 5 | 6.2 | | 6.3 | 6.5 | | 5.8 | 6.4 | 6.5 | 5.6 | 5.8 | 6 | 240 |
| 245 | | | | | | | | | | | | | | | | 6.1 | 6.2 | | 5.4 | 5.9 | 6 | 5.3 | 5.6 | 5.8 | 245 |
| 250 | | | | | | | | | | | | | | | | 5.7 | 6 | | 5.2 | 5.3 | | 5.1 | 5.3 | 5.5 | 250 |
| 255 | | | | | | | | | | | | | | | | 4.6 | 5.1 | | 5.1 | 5.2 | | 4.6 | 5.1 | 5.2 | 255 |
| 260 | | | | | | | | | | | | | | | | | | | 4.9 | 5 | | 4 | 4.7 | 4.8 | 260 |
| 265 | | | | | | | | | | | | | | | | | | | 4.6 | 4.8 | | 3.4 | 4 | | 265 |
| 270 | | | | | | | | | | | | | | | | | | | 2.6 | 4 | | 2.9 | 3.4 | | 270 |
| 275 | | | | | | | | | | | | | | | | | | | | | | 2.4 | 2.8 | | 275 |
| 280 | | | | | | | | | | | | | | | | | | | | | | | 2.2 | | 280 |

* adapter - pièce d'adaptateur

t_240_003_50201_00_000 / 52201_00_000 / 54201_00_000

Lifting capacities Forces de levage

TF



| ft | 48 + 6.6 ft* | | | 144 + 6.6 ft* | | | 160 + 6.6 ft* | | | 176 + 6.6 ft* | | | 192 + 6.6 ft* | | | 208 + 6.6 ft* | | | 224 + 6.6 ft* | | | 240 + 6.6 ft* | | | ft | | |
|-----|--------------|------|------|---------------|------|------|---------------|------|------|---------------|------|------|---------------|------|------|---------------|-----|------|---------------|------|------|---------------|------|-----|-----|-----|-----|
| | 69 ft | | | 69 ft | | | 69 ft | | | 69 ft | | | 69 ft | | | 69 ft | | | 69 ft | | | | | | | | |
| | 0° | 20° | 40° | 0° | 20° | 40° | 0° | 20° | 40° | 0° | 20° | 40° | 0° | 20° | 40° | 0° | 20° | 40° | 0° | 20° | 40° | 0° | 20° | 40° | | | |
| 16 | 38.6 | | | | | | | | | | | | | | | | | | | | | | | 16 | | | |
| 17 | 38.6 | | | | | | | | | | | | | | | | | | | | | | | 17 | | | |
| 18 | 38.3 | | | | | | | | | | | | | | | | | | | | | | | 18 | | | |
| 19 | 37.8 | | | | | | | | | | | | | | | | | | | | | | | 19 | | | |
| 20 | 37.3 | | | | | | | | | | | | | | | | | | | | | | | 20 | | | |
| 22 | 36.1 | | | | | | | | | | | | | | | | | | | | | | | 22 | | | |
| 24 | 34.8 | | | | | | | | | | | | | | | | | | | | | | | 24 | | | |
| 26 | 33.6 | | | | | | | | | | | | | | | | | | | | | | | 26 | | | |
| 28 | 32.4 | | | | | | | | | | | | | | | | | | | | | | | 28 | | | |
| 30 | 31.3 | | | | | | | | | | | | | | | | | | | | | | | 30 | | | |
| 32 | 30.3 | | | | | | | | | | | | | | | | | | | | | | | 32 | | | |
| 34 | 29.3 | | | | | | | | | | | | | | | | | | | | | | | 34 | | | |
| 36 | 28.3 | | | | 38.1 | | | | | | | | | | | | | | | | | | | 36 | | | |
| 38 | 27.3 | | | | 37.6 | | | | | | | | | | | | | | | | | | | 38 | | | |
| 40 | 26.4 | 23.8 | | | 36.9 | | | 34.5 | | | | | | | | | | | | | | | | 40 | | | |
| 45 | 24.2 | 22.8 | | | 35.2 | | | 33.4 | | | 30.3 | | | | | | | | | | | | | 45 | | | |
| 50 | 22.2 | 21.4 | | | 33.4 | | | 32.1 | | | 29.6 | | 25.4 | | | | | | | | | | | 50 | | | |
| 55 | 20.5 | 19.9 | | | 31.8 | | | 30.7 | | | 28.8 | | 25.1 | | 21.3 | | | | | | | | | 55 | | | |
| 60 | 18.9 | 18.5 | 17 | | 30.3 | 23.7 | | 29.4 | | | 27.8 | | 24.8 | | 21.1 | | | 17.5 | | | | | | 60 | | | |
| 65 | 17.6 | 17.3 | 16.1 | | 28.9 | 23 | | 28.2 | 22.6 | | 26.8 | | 24.4 | | 20.9 | | | 17.2 | | | | 13.6 | | 65 | | | |
| 70 | 16.3 | 16.1 | 15.3 | | 27.5 | 22.2 | | 27.1 | 22 | | 25.9 | 21.4 | 24 | | 20.7 | | | 17 | | | | 13.4 | | 70 | | | |
| 75 | 15.3 | 15.2 | 14.6 | | 26.3 | 21.4 | | 26 | 21.2 | | 25 | 20.7 | 23.5 | 19.5 | 20.4 | | | 16.7 | | | | 13.1 | | 75 | | | |
| 80 | 14.3 | 14.3 | 13.9 | | 25 | 20.6 | 16.9 | 24.9 | 20.5 | | 24.1 | 20 | 22.9 | 19 | 20.1 | | | 16.5 | | | | 12.9 | | 80 | | | |
| 85 | 13.4 | 13.5 | 13.3 | | 23.8 | 19.8 | 16.4 | 23.9 | 19.8 | 16.3 | 23.2 | 19.3 | 22.2 | 18.5 | 19.7 | 17.1 | | 16.3 | | | | 12.8 | | 85 | | | |
| 90 | 12.7 | 12.7 | 12.6 | | 22.7 | 19 | 15.9 | 22.9 | 19 | 15.9 | 22.4 | 18.7 | 15.7 | 21.5 | 17.9 | | | 16.1 | 15.1 | | | 12.6 | | 90 | | | |
| 95 | 12 | 12.1 | 12.1 | | 21.7 | 18.3 | 15.5 | 21.9 | 18.4 | 15.5 | 21.6 | 18.1 | 15.4 | 20.8 | 17.4 | 15 | | 15.9 | 14.8 | | | 12.3 | 11.3 | 95 | | | |
| 100 | 11.4 | 11.5 | 11.6 | | 20.7 | 17.7 | 15.2 | 20.9 | 17.8 | 15.2 | 20.8 | 17.5 | 15 | 20.2 | 16.9 | 14.7 | | 15.5 | 14.6 | | | 12 | 11 | 100 | | | |
| 105 | 10.8 | 11 | 11.2 | | 19.7 | 17 | 14.8 | 20.1 | 17.2 | 14.9 | 20 | 17 | 14.8 | 19.5 | 16.4 | 14.4 | | 15.1 | 14.2 | | | 11.7 | 10.7 | 105 | | | |
| 110 | 10.4 | 10.6 | 10.4 | | 18.9 | 16.4 | 14.5 | 19.3 | 16.6 | 14.5 | 19.2 | 16.5 | 14.5 | 18.9 | 16 | 14.2 | | 14.4 | 13.9 | 12.9 | | 11.3 | 10.3 | 110 | | | |
| 115 | 10.1 | 10.5 | | | 18.2 | 15.9 | 14.2 | 18.6 | 16.1 | 14.2 | 18.6 | 16 | 14.2 | 18.3 | 15.5 | 13.9 | | 14.4 | 13.6 | 12.6 | | 11 | 10 | 9.6 | 115 | | |
| 120 | | | | | 17.5 | 15.4 | 13.9 | 17.9 | 15.6 | 13.9 | 18 | 15.5 | 13.9 | 17.7 | 15.1 | 13.6 | | 14.4 | 13.1 | 13.9 | 13.3 | 12.4 | 10.7 | 9.8 | 9.3 | 120 | |
| 125 | | | | | 16.7 | 14.9 | 13.5 | 17.2 | 15.1 | 13.6 | 17.4 | 15.1 | 13.6 | 17.2 | 14.7 | 13.4 | | 14.1 | 12.8 | 13.5 | 12.9 | 12.2 | 10.3 | 9.5 | 9 | 125 | |
| 130 | | | | | 16 | 14.4 | 13.2 | 16.6 | 14.7 | 13.3 | 16.8 | 14.7 | 13.3 | 16.7 | 14.3 | 13.1 | | 13.8 | 12.6 | 13.1 | 12.6 | 12 | 10 | 9.2 | 8.8 | 130 | |
| 135 | | | | | 15.5 | 14 | 12.9 | 16 | 14.3 | 13 | 16.2 | 14.3 | 13 | 16.2 | 14 | 12.8 | | 13.4 | 12.4 | 12.6 | 12.2 | 11.8 | 9.8 | 8.9 | 8.6 | 135 | |
| 140 | | | | | 14.9 | 13.6 | 12.6 | 15.4 | 13.8 | 12.8 | 15.8 | 13.9 | 12.8 | 15.7 | 13.7 | 12.6 | | 13.1 | 12.2 | 12.2 | 11.9 | 11.6 | 9.5 | 8.7 | 8.4 | 140 | |
| 145 | | | | | 14.4 | 13.2 | 12.4 | 14.9 | 13.4 | 12.5 | 15.3 | 13.5 | 12.5 | 15.3 | 13.3 | 12.4 | | 12.9 | 12 | 11.8 | 11.5 | 11.3 | 9.2 | 8.5 | 8.2 | 145 | |
| 150 | | | | | 13.9 | 12.8 | 12.1 | 14.4 | 13.1 | 12.3 | 14.8 | 13.2 | 12.3 | 14.9 | 13 | 12.1 | | 12.6 | 11.8 | 11.4 | 11.2 | 11 | 8.9 | 8.2 | 7.9 | 150 | |
| 155 | | | | | 13.4 | 12.5 | 11.9 | 14 | 12.8 | 12.1 | 14.4 | 12.9 | 12.1 | 14.5 | 12.7 | 11.9 | | 12.4 | 11.7 | 11 | 10.8 | 10.8 | 8.6 | 8 | 7.8 | 155 | |
| 160 | | | | | 13 | 12.2 | 11.7 | 13.5 | 12.5 | 11.9 | 14 | 12.6 | 11.9 | 14.1 | 12.5 | 11.7 | | 12.1 | 11.5 | 10.6 | 10.5 | 10.5 | 8.4 | 7.8 | 7.6 | 160 | |
| 165 | | | | | 12.6 | 11.9 | 11.5 | 13.1 | 12.2 | 11.7 | 13.6 | 12.3 | 11.7 | 13.7 | 12.2 | 11.6 | | 11.8 | 11.3 | 10.3 | 10.2 | 10.2 | 8.2 | 7.6 | 7.4 | 165 | |
| 170 | | | | | 12.2 | 11.6 | 11.4 | 12.7 | 11.9 | 11.5 | 13.2 | 12 | 11.5 | 13.3 | 11.9 | 11.4 | | 11.6 | 11.2 | 9.9 | 9.8 | 9.9 | 7.9 | 7.4 | 7.3 | 170 | |
| 175 | | | | | 11.8 | 11.3 | 11.3 | 12.4 | 11.6 | 11.3 | 12.8 | 11.8 | 11.4 | 12.9 | 11.7 | 11.3 | | 11.3 | 11.1 | 9.6 | 9.5 | 9.7 | 7.7 | 7.2 | 7.1 | 175 | |
| 180 | | | | | 11.5 | 11.1 | 11.2 | 12 | 11.4 | 11.2 | 12.5 | 11.5 | 11.3 | 12.6 | 11.5 | 11.1 | | 11 | 10.9 | 9.2 | 9.2 | 9.4 | 7.5 | 7.1 | 7 | 180 | |
| 185 | | | | | 11.2 | 10.9 | 11.2 | 11.7 | 11.2 | 11.1 | 12.2 | 11.3 | 11.1 | 12.2 | 11.3 | 11 | | 10.8 | 10.7 | 8.9 | 8.9 | 9.1 | 7.3 | 6.9 | 6.8 | 185 | |
| 190 | | | | | 10.9 | 10.7 | 11.2 | 11.4 | 11 | 11.1 | 11.8 | 11.1 | 11 | 11.8 | 11.1 | 10.9 | | 10.4 | 10.4 | 8.6 | 8.6 | 8.8 | 7.1 | 6.8 | 6.7 | 190 | |
| 195 | | | | | 10.6 | 10.6 | | 11.1 | 10.8 | 11 | 11.5 | 10.9 | 11 | 11.4 | 10.9 | 10.8 | | 10 | 10.1 | 8.3 | 8.3 | 8.5 | 6.9 | 6.7 | 6.6 | 195 | |
| 200 | | | | | 10.3 | 10.5 | | 10.8 | 10.6 | 11 | 11.2 | 10.7 | 10.9 | 10.8 | 10.7 | 10.7 | | 9.5 | 9.7 | 8 | 8 | 8.2 | 6.7 | 6.5 | 6.5 | 200 | |
| 205 | | | | | 10.1 | 10.5 | | 10.6 | 10.5 | | 10.9 | 10.6 | 10.9 | 10.4 | 10.5 | 10.6 | | 9.1 | 9.4 | 8 | 8 | 8.2 | 6.6 | 6.4 | 6.4 | 205 | |
| 210 | | | | | | | | 10.4 | 10.4 | | 10.5 | 10.4 | 10.9 | 9.6 | 10.3 | 10.4 | | 8.7 | 9 | 7.5 | 7.5 | 7.7 | 6.4 | 6.2 | 6.3 | 210 | |
| 215 | | | | | | | | 10.2 | 10.3 | | 10.1 | 10.1 | 10.5 | 8.9 | 9.8 | 10.1 | | 8.3 | 8.7 | 7.3 | 7.3 | 7.4 | 6.2 | 6.1 | 6.2 | 215 | |
| 220 | | | | | | | | 7.6 | 10.1 | | 9.6 | 9.8 | | 8.1 | 9.1 | 9.5 | | 7.9 | 8.3 | 7 | 7.1 | 7.2 | 6 | 6 | 6.1 | 220 | |
| 225 | | | | | | | | 3.6 | | | 8.9 | 9.5 | | 7.7 | 8.3 | 8.6 | | 7.5 | 7.9 | 6.7 | 6.9 | 7 | 5.8 | 5.9 | 6 | 225 | |
| 230 | | | | | | | | | | | 8.3 | 8.7 | | 7.4 | 7.6 | 7.7 | | 6.9 | 7.5 | 6.4 | 6.7 | 6.8 | 5.7 | 5.7 | 5.9 | 230 | |
| 235 | | | | | | | | | | | 5.9 | 7.8 | | 7.1 | 7.3 | | | 6.4 | 7.1 | 6.3 | 6.1 | 6.5 | 5.5 | 5.6 | 5.7 | 235 | |
| 240 | | | | | | | | | | | 2.2 | 3.7 | | 6.9 | 7 | | | 6 | 6.5 | 5.8 | 5.8 | 6.4 | 5.2 | 5.4 | 5.5 | 240 | |
| 245 | | | | | | | | | | | | | | 6.6 | 6.8 | | | 5.8 | 6 | 6.1 | 5.4 | 6 | 5 | 5.2 | 5.4 | 245 | |
| 250 | | | | | | | | | | | | | | 4.4 | 6.2 | | | 5.5 | 5.7 | | 4.9 | 5.6 | 4.7 | 5.1 | 5.2 | 250 | |
| 255 | | | | | | | | | | | | | | 4.1 | 4.3 | | | 5.3 | 5.5 | | 4.7 | 5.1 | 4.5 | 4.9 | 5 | 255 | |
| 260 | | | | | | | | | | | | | | | | | | 5.1 | 5.3 | | 4.5 | 4.6 | 4.2 | 4.6 | 4.8 | 260 | |
| 265 | | | | | | | | | | | | | | | | | | 3.9 | 4.9 | | 4.3 | 4.5 | 3.7 | 4.3 | 4.5 | 265 | |
| 270 | | | | | | | | | | | | | | | | | | | 3.3 | | | 4.2 | 4.3 | 3.1 | 3.9 | 4 | 270 |
| 275 | | | | | | | | | | | | | | | | | | | | | | 4 | 4.1 | 2.6 | 3.3 | 275 | |
| 280 | | | | | | | | | | | | | | | | | | | | | | 2.2 | 3.8 | 2.7 | | 280 | |

* adapter - pièce d'adaptateur

t_240_003_50301_00_000 / 52301_00_000 / 54301_00_000

Lifting capacities Forces de levage

TF



| ft | 48 + 6.6 ft* | | | 144 + 6.6 ft* | | | 160 + 6.6 ft* | | | 176 + 6.6 ft* | | | 192 + 6.6 ft* | | | 208 + 6.6 ft* | | | 224 + 6.6 ft* | | | 240 + 6.6 ft* | | | ft | | | | |
|-----|--------------|------|------|---------------|------|------|---------------|------|------|---------------|------|------|---------------|------|------|---------------|------|------|---------------|------|------|---------------|------|------|-----|-----|-----|-----|-----|
| | 80 ft | | | 80 ft | | | 80 ft | | | 80 ft | | | 80 ft | | | 80 ft | | | 80 ft | | | | | | | | | | |
| | 0° | 20° | 40° | 0° | 20° | 40° | 0° | 20° | 40° | 0° | 20° | 40° | 0° | 20° | 40° | 0° | 20° | 40° | 0° | 20° | 40° | 0° | 20° | 40° | | | | | |
| 18 | 31.8 | | | | | | | | | | | | | | | | | | | | | | | 18 | | | | | |
| 19 | 31.8 | | | | | | | | | | | | | | | | | | | | | | | 19 | | | | | |
| 20 | 31.5 | | | | | | | | | | | | | | | | | | | | | | | 20 | | | | | |
| 22 | 30.7 | | | | | | | | | | | | | | | | | | | | | | | 22 | | | | | |
| 24 | 29.8 | | | | | | | | | | | | | | | | | | | | | | | 24 | | | | | |
| 26 | 29 | | | | | | | | | | | | | | | | | | | | | | | 26 | | | | | |
| 28 | 28.2 | | | | | | | | | | | | | | | | | | | | | | | 28 | | | | | |
| 30 | 27.4 | | | | | | | | | | | | | | | | | | | | | | | 30 | | | | | |
| 32 | 26.6 | | | | | | | | | | | | | | | | | | | | | | | 32 | | | | | |
| 34 | 25.9 | | | | | | | | | | | | | | | | | | | | | | | 34 | | | | | |
| 36 | 25.1 | | | | | | | | | | | | | | | | | | | | | | | 36 | | | | | |
| 38 | 24.4 | | | | 31.3 | | | | | | | | | | | | | | | | | | | 38 | | | | | |
| 40 | 23.6 | | | | 30.9 | | | 27 | | | | | | | | | | | | | | | | 40 | | | | | |
| 45 | 21.9 | | | | 29.6 | | | 28.4 | | | 26.1 | | | | | | | | | | | | | 45 | | | | | |
| 50 | 20.3 | 18.2 | | | 28.4 | | | 27.3 | | | 25.6 | | | 22.2 | | | | | | | | | | 50 | | | | | |
| 55 | 18.8 | 17.2 | | | 27.2 | | | 26.4 | | | 25.1 | | | 22 | | | | | | | | | | 55 | | | | | |
| 60 | 17.5 | 16.3 | | | 26.1 | | | 25.8 | | | 24.5 | | | 21.7 | | 18.5 | | | | | | | | 60 | | | | | |
| 65 | 16.2 | 15.5 | | | 25 | | | 24.9 | | | 23.8 | | | 21.3 | | 18.3 | | 15 | | | | | | 65 | | | | | |
| 70 | 15.1 | 14.7 | 13.1 | | 23.9 | 18.2 | | 24 | 17.9 | | 23 | | | 20.9 | | 18.1 | | 14.7 | | | | 11.4 | | 70 | | | | | |
| 75 | 14 | 13.9 | 12.6 | | 22.9 | 17.6 | | 23.1 | 17.5 | | 22.3 | | | 20.5 | | 17.8 | | 14.4 | | | | 11.2 | | 75 | | | | | |
| 80 | 13.1 | 13 | 12.1 | | 21.9 | 17.1 | | 22.2 | 17 | | 21.6 | 16.6 | | 19.9 | | 17.5 | | 14.2 | | | | 11 | | 80 | | | | | |
| 85 | 12.3 | 12.3 | 11.7 | 21 | 16.6 | | | 21.4 | 16.5 | | 20.9 | 16.2 | | 19.4 | 15.6 | | 17.2 | | 14 | | | 10.9 | | 85 | | | | | |
| 90 | 11.5 | 11.6 | 11.2 | 20.1 | 16.1 | 13.1 | | 20.6 | 16.1 | | 20.2 | 15.8 | | 18.9 | 15.3 | | 16.8 | 14.2 | | 13.9 | | 10.7 | | 90 | | | | | |
| 95 | 10.9 | 11 | 10.8 | 19.2 | 15.7 | 12.8 | | 19.8 | 15.7 | 12.8 | 19.5 | 15.4 | | 18.3 | 14.9 | | 16.5 | 13.9 | | 13.7 | 10.4 | | 10.6 | 95 | | | | | |
| 100 | 10.3 | 10.4 | 10.3 | 18.4 | 15.2 | 12.5 | | 18.9 | 15.3 | 12.5 | 18.8 | 15.1 | 12.5 | 17.8 | 14.6 | | 16.1 | 13.6 | | 13.5 | 12.4 | | 10.5 | 100 | | | | | |
| 105 | 9.7 | 9.9 | 9.9 | 17.6 | 14.8 | 12.3 | | 18.2 | 14.8 | 12.3 | 18.1 | 14.7 | 12.2 | 17.2 | 14.2 | 12.1 | | 15.7 | 13.3 | | 13.3 | 12.2 | | 10.3 | 9.4 | 105 | | | |
| 110 | 9.2 | 9.4 | 9.5 | 16.8 | 14.3 | 12 | | 17.5 | 14.4 | 12.1 | 17.4 | 14.3 | 12 | 16.7 | 13.8 | 11.8 | | 15.4 | 13 | 11.5 | 13.1 | 11.9 | | 10.1 | 9.1 | 110 | | | |
| 115 | 8.8 | 9 | 9.2 | 16.1 | 13.9 | 11.8 | | 16.8 | 14 | 11.8 | 16.8 | 13.9 | 11.8 | 16.2 | 13.5 | 11.6 | | 15 | 12.8 | 11.2 | 12.9 | 11.7 | | 9.8 | 8.8 | 115 | | | |
| 120 | 8.4 | 8.6 | 9.1 | 15.4 | 13.4 | 11.6 | | 16.1 | 13.5 | 11.6 | 16.2 | 13.5 | 11.6 | 15.7 | 13.1 | 11.4 | | 14.6 | 12.5 | 11 | 12.7 | 11.5 | 10.5 | | 9.5 | 8.6 | 120 | | |
| 125 | 8.2 | 8.4 | | 14.8 | 12.9 | 11.4 | | 15.5 | 13.1 | 11.4 | 15.7 | 13.1 | 11.4 | 15.1 | 12.8 | 11.2 | | 14.2 | 12.2 | 10.9 | 12.3 | 11.3 | 10.4 | | 9.2 | 8.3 | 7.9 | 125 | |
| 130 | | | | 14.2 | 12.5 | 11.2 | | 15 | 12.7 | 11.2 | 15.1 | 12.7 | 11.1 | 14.7 | 12.4 | 11 | | 13.8 | 11.9 | 10.7 | 12 | 11 | 10.2 | | 8.9 | 8.1 | 7.7 | 130 | |
| 135 | | | | 13.6 | 12.2 | 10.9 | | 14.4 | 12.3 | 11 | 14.6 | 12.3 | 10.9 | 14.2 | 12.1 | 10.8 | | 13.5 | 11.6 | 10.5 | 11.6 | 10.8 | 10 | | 8.6 | 7.8 | 7.5 | 135 | |
| 140 | | | | 13.1 | 11.8 | 10.7 | | 13.9 | 12 | 10.8 | 14.1 | 12 | 10.8 | 13.8 | 11.8 | 10.6 | | 13.1 | 11.3 | 10.3 | 11.2 | 10.6 | 9.8 | | 8.4 | 7.6 | 7.3 | 140 | |
| 145 | | | | 12.6 | 11.4 | 10.5 | | 13.4 | 11.7 | 10.6 | 13.7 | 11.7 | 10.6 | 13.4 | 11.5 | 10.4 | | 12.7 | 11.1 | 10.1 | 10.8 | 10.3 | 9.7 | | 8.1 | 7.4 | 7.1 | 145 | |
| 150 | | | | 12.2 | 11.1 | 10.3 | | 12.9 | 11.3 | 10.4 | 13.2 | 11.4 | 10.4 | 13 | 11.2 | 10.2 | | 12.4 | 10.8 | 10 | 10.5 | 10 | 9.5 | | 7.8 | 7.2 | 7 | 150 | |
| 155 | | | | 11.7 | 10.8 | 10.1 | | 12.5 | 11 | 10.2 | 12.8 | 11.1 | 10.2 | 12.6 | 10.9 | 10.1 | | 12.1 | 10.6 | 9.8 | 10.1 | 9.8 | 9.4 | | 7.6 | 7 | 6.8 | 155 | |
| 160 | | | | 11.3 | 10.5 | 9.9 | | 12.1 | 10.7 | 10 | 12.4 | 10.8 | 10 | 12.3 | 10.7 | 9.9 | | 11.7 | 10.4 | 9.6 | 9.8 | 9.5 | 9.2 | | 7.4 | 6.9 | 6.7 | 160 | |
| 165 | | | | 10.9 | 10.2 | 9.7 | | 11.7 | 10.4 | 9.8 | 12 | 10.5 | 9.8 | 11.9 | 10.4 | 9.7 | | 11.4 | 10.1 | 9.5 | 9.4 | 9.2 | 9.1 | | 7.2 | 6.7 | 6.5 | 165 | |
| 170 | | | | 10.6 | 9.9 | 9.5 | | 11.4 | 10.1 | 9.6 | 11.6 | 10.3 | 9.6 | 11.6 | 10.2 | 9.6 | | 11.1 | 9.9 | 9.4 | 9.1 | 9 | 8.9 | | 7 | 6.5 | 6.4 | 170 | |
| 175 | | | | 10.2 | 9.7 | 9.4 | | 11 | 9.9 | 9.5 | 11.3 | 10 | 9.5 | 11.3 | 10 | 9.4 | | 10.7 | 9.7 | 9.2 | 8.7 | 8.7 | 8.7 | | 6.8 | 6.4 | 6.3 | 175 | |
| 180 | | | | 9.9 | 9.4 | 9.2 | | 10.7 | 9.7 | 9.3 | 11 | 9.8 | 9.4 | 11 | 9.7 | 9.3 | | 10.3 | 9.6 | 9.1 | 8.4 | 8.4 | 8.5 | | 6.6 | 6.2 | 6.1 | 180 | |
| 185 | | | | 9.6 | 9.2 | 9.1 | | 10.4 | 9.5 | 9.2 | 10.7 | 9.6 | 9.2 | 10.7 | 9.5 | 9.2 | | 10 | 9.4 | 9 | 8.2 | 8.2 | 8.3 | | 6.5 | 6.1 | 6 | 185 | |
| 190 | | | | 9.3 | 9 | 9.1 | | 10.1 | 9.3 | 9.1 | 10.4 | 9.4 | 9.1 | 10.4 | 9.4 | 9.1 | | 9.6 | 9.2 | 8.9 | 7.9 | 7.9 | 8 | | 6.3 | 6 | 5.9 | 190 | |
| 195 | | | | 9 | 8.8 | 9.1 | | 9.8 | 9.1 | 9 | 10.1 | 9.2 | 9 | 10.2 | 9.2 | 9 | | 9.3 | 9 | 8.8 | 7.6 | 7.7 | 7.8 | | 6.2 | 5.8 | 5.7 | 195 | |
| 200 | | | | 8.8 | 8.7 | 9.1 | | 9.5 | 8.9 | 9 | 9.9 | 9 | 8.9 | 9.9 | 9 | 8.9 | | 8.9 | 8.8 | 8.7 | 7.4 | 7.4 | 7.6 | | 6 | 5.7 | 5.6 | 200 | |
| 205 | | | | 8.6 | 8.5 | | | 9.3 | 8.7 | 9 | 9.6 | 8.9 | 8.9 | 9.6 | 8.9 | 8.8 | | 8.6 | 8.5 | 8.6 | 7.1 | 7.1 | 7.3 | | 5.9 | 5.6 | 5.5 | 205 | |
| 210 | | | | 8.4 | 8.5 | | | 9 | 8.6 | 9 | 9.4 | 8.7 | 8.8 | 9.2 | 8.7 | 8.7 | | 8.2 | 8.3 | 8.5 | 6.8 | 6.9 | 7.1 | | 5.7 | 5.5 | 5.4 | 210 | |
| 215 | | | | 8.2 | 8.4 | | | 8.8 | 8.5 | 9 | 9.1 | 8.6 | 8.8 | 8.9 | 8.6 | 8.7 | | 7.9 | 8.1 | 8.3 | 6.6 | 6.7 | 6.9 | | 5.6 | 5.3 | 5.3 | 215 | |
| 220 | | | | 5.8 | 7.9 | | | 8.6 | 8.4 | | 8.8 | 8.5 | 8.8 | 8.4 | 8.4 | 8.7 | | 7.5 | 7.8 | 8.1 | 6.4 | 6.5 | 6.7 | | 5.5 | 5.2 | 5.2 | 220 | |
| 225 | | | | | | | | 8.4 | 8.4 | | 8.6 | 8.4 | 8.8 | 7.7 | 8.2 | 8.6 | | 7.2 | 7.5 | 7.8 | 6.2 | 6.3 | 6.5 | | 5.3 | 5.1 | 5.2 | 225 | |
| 230 | | | | | | | | 7.4 | 8.4 | | 8.3 | 8.2 | | 7.1 | 7.9 | 8.3 | | 6.9 | 7.2 | 7.6 | 6 | 6.1 | 6.3 | | 5.1 | 5 | 5.1 | 230 | |
| 235 | | | | | | | | 4.1 | 5.9 | | 7.9 | 8.2 | | 6.7 | 7.4 | 7.7 | | 6.5 | 7 | 7.2 | 5.8 | 5.9 | 6.2 | | 5 | 4.9 | 5 | 235 | |
| 240 | | | | | | | | | | | 7.3 | 7.8 | | 6.5 | 6.8 | 7 | | 6 | 6.6 | 6.9 | 5.5 | 5.8 | 6 | | 4.8 | 4.8 | 4.9 | 240 | |
| 245 | | | | | | | | | | | 5.5 | 7.2 | | 6.2 | 6.4 | | | 5.4 | 6.3 | 6.5 | 5.2 | 5.6 | 5.8 | | 4.6 | 4.7 | 4.8 | 245 | |
| 250 | | | | | | | | | | | 2.4 | 4.4 | | 6 | 6.2 | | | 5.1 | 5.8 | 6 | 4.9 | 5.4 | 5.6 | 4.4 | | 4.6 | 4.7 | 250 | |
| 255 | | | | | | | | | | | | | | 5.7 | 5.9 | | | 4.9 | 5.2 | 5.4 | 4.4 | 5.1 | 5.3 | 4.2 | | 4.4 | 4.6 | 255 | |
| 260 | | | | | | | | | | | | | | 3.9 | 5.6 | | | 4.7 | 4.9 | | 4 | 4.8 | 4.9 | 3.9 | | 4.3 | 4.4 | 260 | |
| 265 | | | | | | | | | | | | | | 3.4 | 3.5 | | | 4.6 | 4.7 | | 3.8 | 4.3 | 4.5 | 3.7 | | 4.1 | 4.3 | 265 | |
| 270 | | | | | | | | | | | | | | | | | | 4.3 | 4.5 | | 3.7 | 3.8 | 4 | 3.2 | | 3.8 | 4 | 270 | |
| 275 | | | | | | | | | | | | | | | | | | 3.1 | 4.3 | | 3.5 | 3.6 | | 2.5 | | 3.5 | 3.7 | 275 | |
| 280 | | | | | | | | | | | | | | | | | | | 2.9 | | 3.3 | 3.5 | | | 3.1 | 3.3 | | 280 | |
| 285 | | | | | | | | | | | | | | | | | | | | | 3.1 | 3.3 | | | | | | 285 | |
| 290 | | | | | | | | | | | | | | | | | | | | | | 3.1 | | | | | | | 290 |

* adapter - pièce d'adaptateur

t_240_003_50401_00_000 / 52401_00_000 / 54401_00_000

Lifting capacities Forces de levage

TF



| ft | 48 + 6.6 ft* | | | 144 + 6.6 ft* | | | 160 + 6.6 ft* | | | 176 + 6.6 ft* | | | 192 + 6.6 ft* | | | 208 + 6.6 ft* | | | 224 + 6.6 ft* | | | 240 + 6.6 ft* | | | ft | | |
|-----|--------------|------|-----|---------------|------|------|---------------|------|------|---------------|------|------|---------------|------|------|---------------|------|------|---------------|------|------|---------------|-----|-----|-----|-----|-----|
| | 92 ft | | | 92 ft | | | 92 ft | | | 92 ft | | | 92 ft | | | 92 ft | | | 92 ft | | | | | | | | |
| | 0° | 20° | 40° | 0° | 20° | 40° | 0° | 20° | 40° | 0° | 20° | 40° | 0° | 20° | 40° | 0° | 20° | 40° | 0° | 20° | 40° | 0° | 20° | 40° | | | |
| 19 | 26.8 | | | | | | | | | | | | | | | | | | | | | | | 19 | | | |
| 20 | 27 | | | | | | | | | | | | | | | | | | | | | | | 20 | | | |
| 22 | 26.8 | | | | | | | | | | | | | | | | | | | | | | | 22 | | | |
| 24 | 26.2 | | | | | | | | | | | | | | | | | | | | | | | 24 | | | |
| 26 | 25.6 | | | | | | | | | | | | | | | | | | | | | | | 26 | | | |
| 28 | 24.9 | | | | | | | | | | | | | | | | | | | | | | | 28 | | | |
| 30 | 24.3 | | | | | | | | | | | | | | | | | | | | | | | 30 | | | |
| 32 | 23.6 | | | | | | | | | | | | | | | | | | | | | | | 32 | | | |
| 34 | 23 | | | | | | | | | | | | | | | | | | | | | | | 34 | | | |
| 36 | 22.4 | | | | | | | | | | | | | | | | | | | | | | | 36 | | | |
| 38 | 21.8 | | | | | | | | | | | | | | | | | | | | | | | 38 | | | |
| 40 | 21.2 | | | | 26.6 | | | | | | | | | | | | | | | | | | | 40 | | | |
| 45 | 19.7 | | | | 25.7 | | | 24.7 | | | | | | | | | | | | | | | | 45 | | | |
| 50 | 18.5 | | | | 24.8 | | | 23.8 | | | 22.4 | | | | | | | | | | | | | 50 | | | |
| 55 | 17.3 | 14.8 | | | 23.8 | | | 22.9 | | | 21.7 | | | 19.3 | | | | | | | | | | 55 | | | |
| 60 | 16.2 | 14 | | | 22.8 | | | 22.1 | | | 21 | | | 19.1 | | | 16.3 | | | | | | | 60 | | | |
| 65 | 15.3 | 13.3 | | | 21.9 | | | 21.4 | | | 20.4 | | | 18.7 | | | 16.1 | | | 13.1 | | | | 65 | | | |
| 70 | 14.4 | 12.7 | | | 21 | | | 20.6 | | | 19.7 | | | 18.2 | | | 15.9 | | | 12.9 | | | 9.8 | 70 | | | |
| 75 | 13.5 | 12.1 | | | 20.1 | 14.7 | | 19.9 | | | 19.1 | | | 17.7 | | | 15.6 | | | 12.7 | | | 9.7 | 75 | | | |
| 80 | 12.7 | 11.5 | 9.9 | | 19.3 | 14.3 | | 19.1 | 14.1 | | 18.4 | | | 17.2 | | | 15.3 | | | 12.5 | | | 9.5 | 80 | | | |
| 85 | 11.8 | 11 | 9.5 | | 18.6 | 13.8 | | 18.4 | 13.7 | | 17.8 | 13.5 | | 16.7 | | | 15.1 | | | 12.4 | | | 9.4 | 85 | | | |
| 90 | 11.1 | 10.5 | 9.2 | | 17.9 | 13.4 | | 17.8 | 13.4 | | 17.3 | 13.1 | | 16.3 | 12.7 | | 14.7 | | | 12.2 | | | 9.3 | 90 | | | |
| 95 | 10.5 | 10 | 8.9 | | 17.1 | 13 | | 17.1 | 13 | | 16.7 | 12.8 | | 15.8 | 12.4 | | 14.4 | 11.7 | | 12 | | | 9.2 | 95 | | | |
| 100 | 9.8 | 9.5 | 8.6 | | 16.5 | 12.7 | 9.9 | 16.5 | 12.6 | 9.9 | 16.2 | 12.4 | | 15.4 | 12.1 | | 14.1 | 11.5 | | 11.9 | | | 9.1 | 100 | | | |
| 105 | 9.3 | 9.1 | 8.4 | | 15.9 | 12.3 | 9.7 | 15.9 | 12.3 | 9.7 | 15.7 | 12.1 | | 14.9 | 11.8 | | 13.8 | 11.3 | | 11.8 | 10.5 | | 9 | 105 | | | |
| 110 | 8.8 | 8.6 | 8.2 | | 15.3 | 12 | 9.5 | 15.4 | 12 | 9.5 | 15.2 | 11.9 | 9.5 | 14.5 | 11.6 | | 13.4 | 11.1 | | 11.6 | 10.2 | | 8.9 | 8.1 | 110 | | |
| 115 | 8.3 | 8.2 | 8 | | 14.8 | 11.7 | 9.3 | 14.9 | 11.7 | 9.3 | 14.7 | 11.6 | 9.3 | 14.2 | 11.3 | 9.2 | 13.1 | 10.8 | | 11.4 | 10.1 | | 8.7 | 7.9 | 115 | | |
| 120 | 7.9 | 7.8 | 7.9 | | 14.3 | 11.4 | 9.1 | 14.4 | 11.4 | 9.2 | 14.3 | 11.3 | 9.1 | 13.8 | 11.1 | 9 | 12.8 | 10.6 | 8.9 | 11.2 | 9.9 | | 8.4 | 7.7 | 120 | | |
| 125 | 7.5 | 7.5 | 7.6 | | 13.7 | 11.1 | 9 | 13.9 | 11.1 | 9 | 13.8 | 11.1 | 9 | 13.4 | 10.8 | 8.9 | 12.5 | 10.5 | 8.7 | 11.1 | 9.7 | | 8.2 | 7.5 | 125 | | |
| 130 | 7.2 | 7.2 | 7.5 | | 13.2 | 10.8 | 8.8 | 13.4 | 10.9 | 8.9 | 13.4 | 10.8 | 8.9 | 13 | 10.6 | 8.8 | 12.2 | 10.2 | 8.6 | 10.8 | 9.5 | 8.4 | 7.9 | 7.3 | 130 | | |
| 135 | 7 | 7.1 | | | 12.7 | 10.5 | 8.7 | 13 | 10.6 | 8.7 | 12.9 | 10.6 | 8.7 | 12.6 | 10.4 | 8.6 | 11.9 | 10 | 8.5 | 10.5 | 9.3 | 8.3 | 7.7 | 7.1 | 6.8 | 135 | |
| 140 | | | | | 12.2 | 10.2 | 8.5 | 12.5 | 10.4 | 8.6 | 12.5 | 10.4 | 8.6 | 12.2 | 10.2 | 8.5 | 11.6 | 9.8 | 8.4 | 10.3 | 9.2 | 8.2 | 7.5 | 6.9 | 6.6 | 140 | |
| 145 | | | | | 11.7 | 10 | 8.4 | 12.1 | 10.1 | 8.5 | 12.1 | 10.1 | 8.5 | 11.9 | 10 | 8.4 | 11.3 | 9.6 | 8.3 | 10 | 9 | 8.1 | 7.3 | 6.7 | 6.5 | 145 | |
| 150 | | | | | 11.3 | 9.7 | 8.3 | 11.7 | 9.9 | 8.4 | 11.7 | 9.9 | 8.4 | 11.5 | 9.8 | 8.3 | 11 | 9.4 | 8.2 | 9.7 | 8.8 | 8 | 7.1 | 6.5 | 6.3 | 150 | |
| 155 | | | | | 10.9 | 9.4 | 8.2 | 11.2 | 9.6 | 8.3 | 11.4 | 9.7 | 8.3 | 11.1 | 9.6 | 8.2 | 10.7 | 9.2 | 8.2 | 9.4 | 8.7 | 8 | 6.9 | 6.4 | 6.1 | 155 | |
| 160 | | | | | 10.5 | 9.2 | 8.2 | 10.9 | 9.3 | 8.2 | 11 | 9.4 | 8.2 | 10.8 | 9.3 | 8.1 | 10.4 | 9 | 8.1 | 9.1 | 8.5 | 7.9 | 6.7 | 6.2 | 6 | 160 | |
| 165 | | | | | 10.1 | 8.9 | 8.1 | 10.5 | 9.1 | 8.1 | 10.7 | 9.2 | 8.1 | 10.5 | 9.1 | 8.1 | 10.1 | 8.8 | 8 | 8.8 | 8.3 | 7.8 | 6.5 | 6.1 | 5.9 | 165 | |
| 170 | | | | | 9.7 | 8.7 | 8 | 10.2 | 8.9 | 8 | 10.3 | 9 | 8 | 10.3 | 8.9 | 8 | 9.9 | 8.6 | 7.9 | 8.5 | 8.1 | 7.7 | 6.4 | 5.9 | 5.7 | 170 | |
| 175 | | | | | 9.4 | 8.4 | 8 | 9.8 | 8.6 | 8 | 10 | 8.7 | 8 | 10 | 8.7 | 8 | 9.6 | 8.4 | 7.8 | 8.2 | 7.9 | 7.6 | 6.2 | 5.8 | 5.6 | 175 | |
| 180 | | | | | 9.1 | 8.2 | 7.9 | 9.5 | 8.4 | 7.9 | 9.7 | 8.5 | 7.9 | 9.7 | 8.5 | 7.9 | 9.4 | 8.2 | 7.8 | 7.9 | 7.7 | 7.5 | 6 | 5.6 | 5.5 | 180 | |
| 185 | | | | | 8.8 | 8 | 7.8 | 9.2 | 8.2 | 7.8 | 9.4 | 8.3 | 7.9 | 9.4 | 8.3 | 7.8 | 9.1 | 8.1 | 7.7 | 7.6 | 7.5 | 7.4 | 5.9 | 5.5 | 5.4 | 185 | |
| 190 | | | | | 8.5 | 7.8 | 7.7 | 8.9 | 8 | 7.7 | 9.2 | 8.1 | 7.7 | 9.1 | 8.1 | 7.7 | 8.9 | 7.9 | 7.6 | 7.3 | 7.4 | 7.3 | 5.7 | 5.4 | 5.2 | 190 | |
| 195 | | | | | 8.3 | 7.6 | 7.6 | 8.7 | 7.8 | 7.6 | 8.9 | 8 | 7.6 | 8.9 | 7.9 | 7.6 | 8.6 | 7.8 | 7.5 | 7.1 | 7.2 | 7.2 | 5.6 | 5.3 | 5.1 | 195 | |
| 200 | | | | | 8 | 7.5 | 7.5 | 8.4 | 7.7 | 7.6 | 8.6 | 7.8 | 7.6 | 8.7 | 7.8 | 7.5 | 8.4 | 7.6 | 7.4 | 6.9 | 7 | 7 | 5.4 | 5.1 | 5 | 200 | |
| 205 | | | | | 7.8 | 7.3 | 7.5 | 8.2 | 7.5 | 7.5 | 8.4 | 7.6 | 7.5 | 8.5 | 7.6 | 7.4 | 8.1 | 7.5 | 7.3 | 6.7 | 6.8 | 6.9 | 5.3 | 5 | 4.9 | 205 | |
| 210 | | | | | 7.5 | 7.2 | 7.5 | 7.9 | 7.4 | 7.5 | 8.2 | 7.5 | 7.4 | 8.3 | 7.5 | 7.3 | 7.8 | 7.4 | 7.3 | 6.5 | 6.6 | 6.7 | 5.2 | 4.9 | 4.9 | 210 | |
| 215 | | | | | 7.4 | 7.1 | | 7.7 | 7.3 | 7.4 | 8 | 7.3 | 7.4 | 8 | 7.4 | 7.3 | 7.6 | 7.3 | 7.2 | 6.3 | 6.4 | 6.5 | 5 | 4.8 | 4.8 | 215 | |
| 220 | | | | | 7.2 | 7.1 | | 7.5 | 7.2 | 7.4 | 7.8 | 7.2 | 7.4 | 7.8 | 7.3 | 7.3 | 7.3 | 7.2 | 7.2 | 6.1 | 6.2 | 6.3 | 4.9 | 4.7 | 4.7 | 220 | |
| 225 | | | | | 7 | 7.1 | | 7.3 | 7.1 | 7.4 | 7.6 | 7.1 | 7.3 | 7.6 | 7.2 | 7.2 | 7 | 7 | 7.1 | 5.9 | 6 | 6.2 | 4.8 | 4.6 | 4.6 | 225 | |
| 230 | | | | | 6.3 | 7.1 | | 7.2 | 7 | | 7.4 | 7 | 7.3 | 7.3 | 7.1 | 7.2 | 6.7 | 6.9 | 7 | 5.7 | 5.8 | 6 | 4.7 | 4.5 | 4.5 | 230 | |
| 235 | | | | | | | | 7 | 7 | | 7.2 | 7 | 7.3 | 6.9 | 7 | 7.2 | 6.4 | 6.7 | 7 | 5.5 | 5.6 | 5.8 | 4.5 | 4.4 | 4.4 | 235 | |
| 240 | | | | | | | | 6.8 | 7 | | 7.1 | 6.9 | 7.3 | 6.4 | 6.9 | 7.2 | 6.1 | 6.5 | 6.8 | 5.3 | 5.4 | 5.6 | 4.4 | 4.3 | 4.4 | 240 | |
| 245 | | | | | | | | 4.3 | 6.5 | | 6.9 | 6.9 | | 6 | 6.7 | 7.1 | 5.7 | 6.3 | 6.5 | 5.1 | 5.2 | 5.5 | 4.2 | 4.2 | 4.3 | 245 | |
| 250 | | | | | | | | | | | 6.7 | 6.9 | | 5.8 | 6.3 | 6.5 | 5.2 | 6 | 6.3 | 4.8 | 5.1 | 5.3 | 4 | 4.1 | 4.2 | 250 | |
| 255 | | | | | | | | | | | 5.3 | 6.7 | | | | | 4.7 | 5.7 | 5.9 | 4.5 | 4.9 | 5.1 | 3.9 | 4 | 4.2 | 255 | |
| 260 | | | | | | | | | | | | 4.9 | | | | | 4.5 | 5.2 | 5.5 | 4.2 | 4.7 | 4.9 | 3.7 | 3.9 | 4.1 | 260 | |
| 265 | | | | | | | | | | | | | | | | | 5.1 | 5.3 | | 4.3 | 4.6 | 4.9 | 3.7 | 4.5 | 4.7 | 265 | |
| 270 | | | | | | | | | | | | | | | | | 3.7 | 5.1 | | 4.1 | 4.3 | | 3.3 | 4.2 | 4.4 | 270 | |
| 275 | | | | | | | | | | | | | | | | | 2.8 | 3.4 | | 3.9 | 4.1 | | 3.2 | 3.7 | 3.9 | 275 | |
| 280 | | | | | | | | | | | | | | | | | | | | 3.7 | 3.9 | | 3 | 3.2 | 3.4 | 280 | |
| 285 | | | | | | | | | | | | | | | | | | | | 2.5 | 3.7 | | 2.9 | 3 | | 2.7 | 285 |
| 290 | | | | | | | | | | | | | | | | | | | | | 2.7 | 2.9 | | | | 2.1 | 290 |
| 295 | | | | | | | | | | | | | | | | | | | | | 2.1 | 2.7 | | | | | 295 |
| 300 | | | | | | | | | | | | | | | | | | | | | | 2.2 | | | | | 300 |

* adapter - pièce d'adaptateur

t_240_003_50501_00_000 / 52501_00_000 / 54501_00_000

Lifting capacities Forces de levage

TF



| ft | 48 + 6.6 ft* | | | 144 + 6.6 ft* | | | 160 + 6.6 ft* | | | 176 + 6.6 ft* | | | 192 + 6.6 ft* | | | 208 + 6.6 ft* | | | 224 + 6.6 ft* | | | 240 + 6.6 ft* | | | ft |
|-----|--------------|------|-----|---------------|------|-----|---------------|------|-----|---------------|------|-----|---------------|------|-----|---------------|-----|-----|---------------|-----|-----|---------------|-----|-----|-----|
| | 103 ft | | | 103 ft | | | 103 ft | | | 103 ft | | | 103 ft | | | 103 ft | | | 103 ft | | | | | | |
| | 0° | 20° | 40° | 0° | 20° | 40° | 0° | 20° | 40° | 0° | 20° | 40° | 0° | 20° | 40° | 0° | 20° | 40° | 0° | 20° | 40° | 0° | 20° | 40° | |
| 22 | 23.1 | | | | | | | | | | | | | | | | | | | | | | | 22 | |
| 24 | 22.9 | | | | | | | | | | | | | | | | | | | | | | | 24 | |
| 26 | 22.4 | | | | | | | | | | | | | | | | | | | | | | | 26 | |
| 28 | 21.8 | | | | | | | | | | | | | | | | | | | | | | | 28 | |
| 30 | 21.2 | | | | | | | | | | | | | | | | | | | | | | | 30 | |
| 32 | 20.7 | | | | | | | | | | | | | | | | | | | | | | | 32 | |
| 34 | 20.1 | | | | | | | | | | | | | | | | | | | | | | | 34 | |
| 36 | 19.6 | | | | | | | | | | | | | | | | | | | | | | | 36 | |
| 38 | 19.1 | | | | | | | | | | | | | | | | | | | | | | | 38 | |
| 40 | 18.6 | | | | | | | | | | | | | | | | | | | | | | | 40 | |
| 45 | 17.4 | | | 22.3 | | | 21.1 | | | | | | | | | | | | | | | | | 45 | |
| 50 | 16.3 | | | 21.3 | | | 20.5 | | | 19.2 | | | | | | | | | | | | | | 50 | |
| 55 | 15.3 | | | 20.5 | | | 19.7 | | | 18.6 | | | | | | | | | | | | | | 55 | |
| 60 | 14.3 | 12.2 | | 19.7 | | | 19 | | | 18 | | | 16.7 | | | | | | | | | | | 60 | |
| 65 | 13.3 | 11.5 | | 18.9 | | | 18.4 | | | 17.5 | | | 16.3 | | | 14.1 | | | | | | | | 65 | |
| 70 | 12.6 | 10.9 | | 18.2 | | | 17.7 | | | 16.9 | | | 15.8 | | | 13.9 | | | 11.2 | | | | | 70 | |
| 75 | 11.9 | 10.3 | | 17.4 | | | 17.1 | | | 16.4 | | | 15.3 | | | 13.6 | | | 11 | | | 8.3 | | 75 | |
| 80 | 11.2 | 9.8 | | 16.7 | 12.1 | | 16.5 | | | 15.9 | | | 14.9 | | | 13.4 | | | 10.8 | | | 8.1 | | 80 | |
| 85 | 10.6 | 9.3 | | 16 | 11.6 | | 15.9 | 11.6 | | 15.4 | | | 14.4 | | | 13.1 | | | 10.6 | | | 8 | | 85 | |
| 90 | 10 | 8.8 | 7.6 | 15.4 | 11.3 | | 15.3 | 11.2 | | 14.9 | 11 | | 14 | | | 12.8 | | | 10.5 | | | 7.9 | | 90 | |
| 95 | 9.5 | 8.4 | 7.3 | 14.8 | 10.9 | | 14.7 | 10.9 | | 14.3 | 10.7 | | 13.6 | 10.3 | | 12.4 | | | 10.4 | | | 7.7 | | 95 | |
| 100 | 8.9 | 8 | 7.1 | 14.2 | 10.6 | | 14.2 | 10.5 | | 13.9 | 10.4 | | 13.2 | 10.1 | | 12.1 | | | 10.3 | | | 7.6 | | 100 | |
| 105 | 8.3 | 7.7 | 6.8 | 13.6 | 10.3 | | 13.7 | 10.2 | | 13.4 | 10.1 | | 12.8 | 9.8 | | 11.8 | 9.4 | | 10.1 | | | 7.5 | | 105 | |
| 110 | 7.9 | 7.3 | 6.6 | 13.1 | 10 | 7.6 | 13.2 | 10 | 7.6 | 13 | 9.8 | | 12.4 | 9.6 | | 11.5 | 9.2 | | 10 | 8.5 | | 7.5 | | 110 | |
| 115 | 7.5 | 7.1 | 6.5 | 12.6 | 9.7 | 7.4 | 12.7 | 9.7 | 7.4 | 12.6 | 9.6 | 7.4 | 12.1 | 9.3 | | 11.2 | 8.9 | | 9.8 | 8.4 | | 7.4 | | 115 | |
| 120 | 7.1 | 6.9 | 6.4 | 12.1 | 9.4 | 7.3 | 12.3 | 9.4 | 7.3 | 12.1 | 9.3 | 7.3 | 11.7 | 9.1 | 7.2 | 11 | 8.7 | | 9.7 | 8.2 | | 7.3 | 6.8 | 120 | |
| 125 | 6.8 | 6.7 | 6.3 | 11.7 | 9.1 | 7.2 | 11.9 | 9.2 | 7.2 | 11.8 | 9.1 | 7.1 | 11.4 | 8.9 | 7.1 | 10.7 | 8.5 | | 9.5 | 8 | | 7.1 | 6.7 | 125 | |
| 130 | 6.5 | 6.5 | 6.2 | 11.3 | 8.8 | 7 | 11.5 | 8.9 | 7 | 11.4 | 8.9 | 7 | 11.1 | 8.7 | 7 | 10.5 | 8.4 | 6.9 | 9.3 | 7.9 | | 7 | 6.5 | 130 | |
| 135 | 6.2 | 6.2 | 6.2 | 10.9 | 8.5 | 6.9 | 11.1 | 8.7 | 6.9 | 11.1 | 8.7 | 6.9 | 10.8 | 8.5 | 6.9 | 10.2 | 8.2 | 6.8 | 9.1 | 7.7 | | 6.9 | 6.3 | 135 | |
| 140 | 6 | 6 | 6.2 | 10.6 | 8.3 | 6.8 | 10.7 | 8.4 | 6.9 | 10.7 | 8.4 | 6.8 | 10.5 | 8.3 | 6.8 | 10 | 8 | 6.7 | 8.9 | 7.6 | 6.5 | 6.7 | 6.1 | 140 | |
| 145 | 5.8 | 5.9 | | 10.2 | 8.1 | 6.7 | 10.4 | 8.2 | 6.7 | 10.4 | 8.2 | 6.7 | 10.2 | 8.1 | 6.7 | 9.7 | 7.9 | 6.6 | 8.7 | 7.5 | 6.4 | 6.5 | 6 | 5.7 | 145 |
| 150 | 5.7 | | | 9.8 | 7.9 | 6.6 | 10.1 | 8 | 6.7 | 10.1 | 8 | 6.7 | 9.9 | 8 | 6.6 | 9.5 | 7.8 | 6.5 | 8.5 | 7.4 | 6.4 | 6.3 | 5.8 | 5.6 | 150 |
| 155 | | | | 9.5 | 7.7 | 6.5 | 9.8 | 7.8 | 6.6 | 9.8 | 7.8 | 6.6 | 9.7 | 7.8 | 6.5 | 9.2 | 7.6 | 6.5 | 8.4 | 7.3 | 6.3 | 6.2 | 5.6 | 5.4 | 155 |
| 160 | | | | 9.1 | 7.5 | 6.5 | 9.5 | 7.6 | 6.5 | 9.5 | 7.7 | 6.5 | 9.4 | 7.6 | 6.5 | 9 | 7.5 | 6.4 | 8.2 | 7.1 | 6.3 | 6 | 5.5 | 5.3 | 160 |
| 165 | | | | 8.8 | 7.3 | 6.4 | 9.2 | 7.5 | 6.4 | 9.3 | 7.5 | 6.4 | 9.2 | 7.5 | 6.4 | 8.8 | 7.3 | 6.3 | 7.9 | 7 | 6.2 | 5.8 | 5.3 | 5.2 | 165 |
| 170 | | | | 8.5 | 7.2 | 6.3 | 8.9 | 7.3 | 6.4 | 9 | 7.3 | 6.4 | 8.9 | 7.3 | 6.3 | 8.6 | 7.2 | 6.3 | 7.7 | 6.9 | 6.2 | 5.6 | 5.2 | 5 | 170 |
| 175 | | | | 8.1 | 7 | 6.3 | 8.6 | 7.2 | 6.3 | 8.7 | 7.2 | 6.3 | 8.7 | 7.2 | 6.3 | 8.3 | 7.1 | 6.2 | 7.5 | 6.8 | 6.1 | 5.5 | 5.1 | 4.9 | 175 |
| 180 | | | | 7.9 | 6.9 | 6.3 | 8.3 | 7 | 6.3 | 8.4 | 7.1 | 6.3 | 8.4 | 7.1 | 6.2 | 8.1 | 7 | 6.2 | 7.2 | 6.7 | 6.1 | 5.3 | 4.9 | 4.8 | 180 |
| 185 | | | | 7.6 | 6.8 | 6.2 | 8 | 6.9 | 6.2 | 8.2 | 7 | 6.2 | 8.2 | 7 | 6.2 | 7.9 | 6.9 | 6.1 | 7 | 6.6 | 6.1 | 5.2 | 4.8 | 4.7 | 185 |
| 190 | | | | 7.4 | 6.7 | 6.2 | 7.7 | 6.8 | 6.2 | 7.9 | 6.9 | 6.2 | 7.9 | 6.9 | 6.2 | 7.7 | 6.8 | 6.1 | 6.7 | 6.5 | 6 | 5.1 | 4.7 | 4.6 | 190 |
| 195 | | | | 7.1 | 6.6 | 6.2 | 7.5 | 6.7 | 6.2 | 7.7 | 6.8 | 6.2 | 7.7 | 6.8 | 6.1 | 7.5 | 6.7 | 6.1 | 6.5 | 6.4 | 6 | 4.9 | 4.6 | 4.5 | 195 |
| 200 | | | | 6.9 | 6.5 | 6.2 | 7.3 | 6.6 | 6.2 | 7.5 | 6.7 | 6.2 | 7.5 | 6.7 | 6.1 | 7.4 | 6.6 | 6 | 6.3 | 6.3 | 6 | 4.8 | 4.5 | 4.4 | 200 |
| 205 | | | | 6.7 | 6.4 | 6.2 | 7.1 | 6.5 | 6.2 | 7.3 | 6.5 | 6.1 | 7.3 | 6.6 | 6.1 | 7.2 | 6.5 | 6 | 6.1 | 6.2 | 6 | 4.6 | 4.3 | 4.3 | 205 |
| 210 | | | | 6.6 | 6.2 | 6.2 | 6.9 | 6.4 | 6.2 | 7.1 | 6.4 | 6.1 | 7.1 | 6.4 | 6.1 | 7 | 6.4 | 6 | 5.9 | 6 | 6 | 4.5 | 4.2 | 4.2 | 210 |
| 215 | | | | 6.4 | 6.1 | 6.2 | 6.7 | 6.2 | 6.2 | 6.9 | 6.3 | 6.1 | 6.9 | 6.3 | 6.1 | 6.8 | 6.2 | 6 | 5.7 | 5.8 | 5.9 | 4.4 | 4.1 | 4.1 | 215 |
| 220 | | | | 6.2 | 6 | 6.2 | 6.6 | 6.1 | 6.2 | 6.8 | 6.2 | 6.1 | 6.8 | 6.2 | 6.1 | 6.6 | 6.2 | 6 | 5.6 | 5.7 | 5.8 | 4.2 | 4 | 4 | 220 |
| 225 | | | | 6.1 | 5.9 | 6.2 | 6.4 | 6.1 | 6.2 | 6.6 | 6.1 | 6.1 | 6.6 | 6.1 | 6.1 | 6.4 | 6.1 | 6 | 5.4 | 5.5 | 5.7 | 4.1 | 3.9 | 3.9 | 225 |
| 230 | | | | 6 | 5.9 | | 6.3 | 6 | 6.2 | 6.4 | 6 | 6.1 | 6.5 | 6 | 6 | 6.2 | 6 | 6 | 5.2 | 5.3 | 5.5 | 4 | 3.8 | 3.8 | 230 |
| 235 | | | | 5.8 | 5.8 | | 6.1 | 5.9 | 6.2 | 6.3 | 5.9 | 6.1 | 6.4 | 6 | 6 | 6 | 5.9 | 5.9 | 5 | 5.1 | 5.4 | 3.9 | 3.7 | 3.7 | 235 |
| 240 | | | | 5.7 | 5.8 | | 6 | 5.8 | | 6.2 | 5.9 | 6.1 | 6.2 | 5.9 | 6 | 5.8 | 5.8 | 5.9 | 4.8 | 5 | 5.2 | 3.7 | 3.6 | 3.7 | 240 |
| 245 | | | | | | | 5.9 | 5.8 | | 6.1 | 5.8 | 6.1 | 6 | 5.8 | 6 | 5.5 | 5.6 | 5.9 | 4.6 | 4.8 | 5 | 3.6 | 3.5 | 3.6 | 245 |
| 250 | | | | | | | 5.8 | 5.8 | | 5.9 | 5.7 | 6.1 | 5.5 | 5.7 | 6 | 5.2 | 5.5 | 5.8 | 4.4 | 4.6 | 4.9 | 3.4 | 3.5 | 3.5 | 250 |
| 255 | | | | | | | 4.2 | 5.8 | | 5.8 | 5.7 | | 5.2 | 5.7 | 6 | 4.7 | 5.4 | 5.7 | 4.2 | 4.4 | 4.7 | 3.3 | 3.4 | 3.5 | 255 |
| 260 | | | | | | | | | | 5.7 | 5.7 | | 5 | 5.6 | 5.8 | 4.2 | 5.2 | 5.5 | 3.9 | 4.3 | 4.5 | 3.1 | 3.3 | 3.4 | 260 |
| 265 | | | | | | | | | | 4.8 | 5.7 | | 4.8 | 5 | 5.2 | 3.8 | 4.8 | 5.2 | 3.6 | 4.1 | 4.4 | 3 | 3.2 | 3.3 | 265 |
| 270 | | | | | | | | | | 2.3 | 5 | | 4.6 | 4.8 | | 3.7 | 4.4 | 4.7 | 3.3 | 3.9 | 4.1 | 2.8 | 3.1 | 3.3 | 270 |
| 275 | | | | | | | | | | | | | 4.3 | 4.6 | | 3.5 | 3.8 | | 2.8 | 3.7 | 3.9 | | 2.9 | 3.2 | 275 |
| 280 | | | | | | | | | | | | | 3.1 | 4.4 | | 3.3 | 3.5 | | 2.5 | 3.4 | 3.5 | | 2.8 | 3 | 280 |
| 285 | | | | | | | | | | | | | | | | 3.1 | 3.3 | | 2.3 | 2.9 | 3.1 | | 2.5 | 2.9 | 285 |
| 290 | | | | | | | | | | | | | | | | 2.8 | 3.1 | | | 2.4 | 2.7 | | | | 290 |
| 295 | | | | | | | | | | | | | | | | | 2.9 | | | 2.3 | | | | | 295 |
| 300 | | | | | | | | | | | | | | | | | 2.1 | | | 2.1 | | | | | 300 |

* adapter - pièce d'adaptateur

t_240_003.50601_00_000 / 52601_00_000 / 54601_00_000

Lifting capacities Forces de levage

TF



| ft | 48 + 6.6 ft* | | | 144 + 6.6 ft* | | | 160 + 6.6 ft* | | | 176 + 6.6 ft* | | | 192 + 6.6 ft* | | | 208 + 6.6 ft* | | | 224 + 6.6 ft* | | | 240 + 6.6 ft* | | | ft | |
|-----|--------------|-----|-----|---------------|------|-----|---------------|------|-----|---------------|------|-----|---------------|-----|-----|---------------|-----|-----|---------------|-----|-----|---------------|-----|-----|-----|-----|
| | 115 ft | | | 115 ft | | | 115 ft | | | 115 ft | | | 115 ft | | | 115 ft | | | 115 ft | | | | | | | |
| | 0° | 20° | 40° | 0° | 20° | 40° | 0° | 20° | 40° | 0° | 20° | 40° | 0° | 20° | 40° | 0° | 20° | 40° | 0° | 20° | 40° | 0° | 20° | 40° | | |
| 24 | 19.6 | | | | | | | | | | | | | | | | | | | | | | | 24 | | |
| 26 | 19.5 | | | | | | | | | | | | | | | | | | | | | | | | 26 | |
| 28 | 19.2 | | | | | | | | | | | | | | | | | | | | | | | | 28 | |
| 30 | 18.7 | | | | | | | | | | | | | | | | | | | | | | | | 30 | |
| 32 | 18.2 | | | | | | | | | | | | | | | | | | | | | | | | 32 | |
| 34 | 17.7 | | | | | | | | | | | | | | | | | | | | | | | | 34 | |
| 36 | 17.2 | | | | | | | | | | | | | | | | | | | | | | | | 36 | |
| 38 | 16.8 | | | | | | | | | | | | | | | | | | | | | | | | 38 | |
| 40 | 16.4 | | | | | | | | | | | | | | | | | | | | | | | | 40 | |
| 45 | 15.4 | | | | 19.3 | | | | | | | | | | | | | | | | | | | | 45 | |
| 50 | 14.5 | | | | 18.6 | | | 17.8 | | | | | | | | | | | | | | | | | 50 | |
| 55 | 13.5 | | | | 17.8 | | | 17.1 | | | 16.2 | | | | | | | | | | | | | | 55 | |
| 60 | 12.7 | | | | 17.1 | | | 16.5 | | | 15.6 | | 14.4 | | | | | | | | | | | | 60 | |
| 65 | 11.9 | 10 | | | 16.4 | | | 15.9 | | | 15.1 | | 14 | | | 12.4 | | | | | | | | | 65 | |
| 70 | 11.1 | 9.5 | | | 15.8 | | | 15.3 | | | 14.6 | | 13.6 | | | 12.2 | | | | | | | | | 70 | |
| 75 | 10.5 | 9 | | | 15.2 | | | 14.8 | | | 14.2 | | 13.3 | | | 11.9 | | | 9.6 | | | | | | 75 | |
| 80 | 9.8 | 8.5 | | | 14.6 | | | 14.3 | | | 13.7 | | 12.9 | | | 11.6 | | | 9.4 | | | 6.9 | | | 80 | |
| 85 | 9.3 | 8 | | | 13.9 | | | 13.7 | | | 13.3 | | 12.5 | | | 11.3 | | | 9.3 | | | 6.9 | | | 85 | |
| 90 | 8.8 | 7.6 | | | 13.4 | 9.6 | | 13.2 | 9.5 | | 12.8 | | 12.1 | | | 11 | | | 9.1 | | | 6.8 | | | 90 | |
| 95 | 8.3 | 7.2 | 6.2 | | 12.8 | 9.2 | | 12.8 | 9.2 | | 12.4 | 9 | 11.7 | | | 10.7 | | | 9 | | | 6.7 | | | 95 | |
| 100 | 7.8 | 6.8 | 6 | | 12.3 | 8.9 | | 12.3 | 8.9 | | 12 | 8.7 | 11.4 | | | 10.4 | | | 8.8 | | | 6.7 | | | 100 | |
| 105 | 7.4 | 6.5 | 5.8 | | 11.8 | 8.6 | | 11.8 | 8.6 | | 11.5 | 8.5 | 11 | 8.2 | | 10.2 | | | 8.7 | | | 6.6 | | | 105 | |
| 110 | 7 | 6.3 | 5.6 | | 11.3 | 8.3 | | 11.4 | 8.3 | | 11.2 | 8.2 | 10.7 | 8 | | 9.9 | 7.6 | | 8.6 | | | 6.5 | | | 110 | |
| 115 | 6.6 | 6 | 5.4 | | 10.9 | 8 | 6.2 | 11 | 8 | | 10.8 | 8 | 10.3 | 7.7 | | 9.6 | 7.4 | | 8.5 | | | 6.4 | | | 115 | |
| 120 | 6.3 | 5.8 | 5.2 | | 10.5 | 7.7 | 6 | 10.5 | 7.8 | 6 | 10.4 | 7.7 | 10 | 7.5 | | 9.4 | 7.2 | | 8.3 | 6.8 | | 6.4 | | | 120 | |
| 125 | 6 | 5.6 | 5.1 | | 10.1 | 7.5 | 5.9 | 10.2 | 7.5 | 5.9 | 10.1 | 7.5 | 9.7 | 7.4 | | 9.1 | 7.1 | | 8.1 | 6.7 | | 6.2 | | | 125 | |
| 130 | 5.7 | 5.4 | 5 | | 9.7 | 7.3 | 5.8 | 9.8 | 7.3 | 5.8 | 9.7 | 7.3 | 9.4 | 7.2 | 5.6 | 8.9 | 6.9 | | 7.9 | 6.6 | | 6.1 | 5.7 | | 130 | |
| 135 | 5.5 | 5.3 | 4.9 | | 9.3 | 7.1 | 5.7 | 9.5 | 7.1 | 5.7 | 9.4 | 7.1 | 9.2 | 7 | 5.6 | 8.6 | 6.8 | | 7.8 | 6.5 | | 5.9 | 5.6 | | 135 | |
| 140 | 5.2 | 5.1 | 4.9 | | 9 | 6.9 | 5.6 | 9.1 | 6.9 | 5.6 | 9.1 | 7 | 8.9 | 6.9 | 5.5 | 8.4 | 6.7 | 5.4 | 7.6 | 6.4 | | 5.8 | 5.4 | | 140 | |
| 145 | 5 | 5 | 4.8 | | 8.7 | 6.7 | 5.5 | 8.8 | 6.8 | 5.5 | 8.8 | 6.8 | 8.6 | 6.7 | 5.4 | 8.2 | 6.6 | 5.3 | 7.5 | 6.3 | | 5.6 | 5.3 | | 145 | |
| 150 | 4.8 | 4.9 | 4.8 | | 8.4 | 6.5 | 5.4 | 8.5 | 6.6 | 5.4 | 8.5 | 6.6 | 8.4 | 6.6 | 5.3 | 8 | 6.4 | 5.3 | 7.3 | 6.2 | 5.1 | 5.5 | 5.1 | | 150 | |
| 155 | 4.7 | 4.9 | 4.8 | | 8.1 | 6.3 | 5.3 | 8.3 | 6.5 | 5.3 | 8.3 | 6.5 | 8.1 | 6.5 | 5.3 | 7.8 | 6.3 | 5.2 | 7.2 | 6.1 | 5.1 | 5.3 | 5 | 4.8 | | 155 |
| 160 | 4.6 | 4.8 | | | 7.8 | 6.2 | 5.2 | 8 | 6.3 | 5.2 | 8 | 6.3 | 7.9 | 6.3 | 5.2 | 7.6 | 6.2 | 5.1 | 7.1 | 5.9 | 5 | 5.2 | 4.8 | 4.7 | | 160 |
| 165 | | | | | 7.5 | 6.1 | 5.1 | 7.8 | 6.2 | 5.2 | 7.8 | 6.2 | 7.7 | 6.2 | 5.1 | 7.4 | 6.1 | 5.1 | 6.9 | 5.9 | 5 | 5 | 4.7 | 4.5 | | 165 |
| 170 | | | | | 7.3 | 5.9 | 5.1 | 7.5 | 6 | 5.1 | 7.6 | 6.1 | 7.4 | 6.1 | 5.1 | 7.2 | 5.9 | 5 | 6.8 | 5.8 | 4.9 | 4.8 | 4.6 | 4.4 | | 170 |
| 175 | | | | | 7 | 5.8 | 5 | 7.3 | 5.9 | 5 | 7.4 | 5.9 | 7.3 | 5.9 | 5 | 7.1 | 5.8 | 5 | 6.6 | 5.7 | 4.9 | 4.7 | 4.4 | 4.3 | | 175 |
| 180 | | | | | 6.8 | 5.7 | 5 | 7 | 5.8 | 5 | 7.2 | 5.8 | 7.1 | 5.8 | 5 | 6.9 | 5.7 | 4.9 | 6.4 | 5.6 | 4.8 | 4.5 | 4.3 | 4.2 | | 180 |
| 185 | | | | | 6.5 | 5.6 | 4.9 | 6.8 | 5.7 | 4.9 | 7 | 5.7 | 7 | 5.7 | 4.9 | 6.8 | 5.6 | 4.9 | 6.3 | 5.5 | 4.8 | 4.4 | 4.2 | 4.1 | | 185 |
| 190 | | | | | 6.3 | 5.4 | 4.9 | 6.6 | 5.6 | 4.9 | 6.8 | 5.6 | 6.8 | 5.6 | 4.9 | 6.6 | 5.5 | 4.8 | 6.1 | 5.4 | 4.8 | 4.3 | 4 | 4 | | 190 |
| 195 | | | | | 6.2 | 5.3 | 4.9 | 6.4 | 5.5 | 4.9 | 6.6 | 5.5 | 6.6 | 5.5 | 4.9 | 6.5 | 5.5 | 4.8 | 5.9 | 5.3 | 4.7 | 4.1 | 3.9 | 3.9 | | 195 |
| 200 | | | | | 6 | 5.3 | 4.9 | 6.2 | 5.4 | 4.8 | 6.4 | 5.4 | 6.5 | 5.4 | 4.8 | 6.4 | 5.4 | 4.8 | 5.7 | 5.3 | 4.7 | 4 | 3.8 | 3.8 | | 200 |
| 205 | | | | | 5.8 | 5.2 | 4.8 | 6 | 5.3 | 4.8 | 6.3 | 5.3 | 6.3 | 5.3 | 4.8 | 6.2 | 5.3 | 4.7 | 5.5 | 5.2 | 4.7 | 3.9 | 3.7 | 3.7 | | 205 |
| 210 | | | | | 5.6 | 5.1 | 4.8 | 5.9 | 5.2 | 4.8 | 6.1 | 5.3 | 6.2 | 5.3 | 4.8 | 6.1 | 5.2 | 4.7 | 5.4 | 5.1 | 4.7 | 3.8 | 3.6 | 3.6 | | 210 |
| 215 | | | | | 5.4 | 5 | 4.8 | 5.7 | 5.1 | 4.8 | 5.9 | 5.2 | 6 | 5.2 | 4.7 | 6 | 5.2 | 4.7 | 5.2 | 5 | 4.7 | 3.6 | 3.5 | 3.5 | | 215 |
| 220 | | | | | 5.3 | 5 | 4.8 | 5.6 | 5.1 | 4.8 | 5.8 | 5.1 | 5.9 | 5.1 | 4.7 | 5.8 | 5.1 | 4.7 | 5 | 4.9 | 4.6 | 3.5 | 3.4 | 3.4 | | 220 |
| 225 | | | | | 5.2 | 4.9 | 4.8 | 5.4 | 5 | 4.8 | 5.6 | 5.1 | 5.8 | 5.1 | 4.7 | 5.7 | 5 | 4.7 | 4.8 | 4.8 | 4.6 | 3.4 | 3.3 | 3.3 | | 225 |
| 230 | | | | | 5 | 4.9 | 4.8 | 5.3 | 5 | 4.8 | 5.5 | 5 | 5.6 | 5 | 4.7 | 5.5 | 5 | 4.7 | 4.6 | 4.7 | 4.6 | 3.3 | 3.2 | 3.3 | | 230 |
| 235 | | | | | 4.9 | 4.9 | 4.8 | 5.2 | 4.9 | 4.8 | 5.4 | 4.9 | 5.5 | 5 | 4.7 | 5.4 | 4.9 | 4.7 | 4.4 | 4.6 | 4.6 | 3.2 | 3.1 | 3.2 | | 235 |
| 240 | | | | | 4.8 | 4.9 | | 5 | 4.9 | 4.8 | 5.2 | 4.9 | 5.4 | 4.9 | 4.7 | 5.2 | 4.9 | 4.7 | 4.2 | 4.5 | 4.6 | 3.1 | 3 | 3.1 | | 240 |
| 245 | | | | | 4.7 | 4.8 | | 4.9 | 4.8 | 4.8 | 5.1 | 4.9 | 5.3 | 4.9 | 4.7 | 5.1 | 4.9 | 4.7 | 4.1 | 4.3 | 4.6 | 3 | 2.9 | 3 | | 245 |
| 250 | | | | | 4.6 | 4.8 | | 4.8 | 4.8 | 4.8 | 5 | 4.8 | 5.2 | 4.8 | 4.7 | 4.9 | 4.8 | 4.7 | 3.9 | 4.1 | 4.4 | 2.9 | 2.8 | 3 | | 250 |
| 255 | | | | | | | | 4.7 | 4.8 | | 4.9 | 4.8 | 5 | 4.8 | 4.7 | 4.6 | 4.7 | 4.7 | 3.7 | 4 | 4.3 | 2.8 | 2.7 | 2.9 | | 255 |
| 260 | | | | | | | | 4.6 | 4.8 | | 4.8 | 4.7 | 4.8 | 4.7 | 4.7 | 4.2 | 4.6 | 4.7 | 3.5 | 3.8 | 4.1 | 2.6 | 2.6 | 2.8 | | 260 |
| 265 | | | | | | | | 4 | 4.8 | | 4.7 | 4.7 | 4.5 | 4.7 | 4.7 | 3.8 | 4.5 | 4.7 | 3.3 | 3.6 | 4 | | 2.6 | 2.8 | | 265 |
| 270 | | | | | | | | | 2.6 | | 4.6 | 4.7 | 4.2 | 4.7 | 4.7 | 3.4 | 4.3 | 4.6 | 3.1 | 3.5 | 3.8 | | 2.5 | 2.7 | | 270 |
| 275 | | | | | | | | | | | 4.1 | 4.7 | 4 | 4.4 | 4.5 | 3 | 4 | 4.4 | 2.8 | 3.3 | 3.6 | | 2.4 | 2.6 | | 275 |
| 280 | | | | | | | | | | | | 4.7 | 3.8 | 4.1 | | 2.9 | 3.6 | 4 | 2.4 | 3.1 | 3.4 | | 2.3 | 2.5 | | 280 |
| 285 | | | | | | | | | | | | | 3.5 | 3.9 | | 2.7 | 3.1 | 3.5 | | 2.9 | 3.1 | | | 2.4 | | 285 |
| 290 | | | | | | | | | | | | | | 2.5 | 3.7 | | 2.5 | 2.8 | 2.9 | | 2.7 | 2.8 | | 2.3 | | 290 |
| 295 | | | | | | | | | | | | | | | 3.1 | | 2.4 | 2.6 | | | 2.5 | | | | | 295 |
| 300 | | | | | | | | | | | | | | | | | 2.4 | | | | | | | | | 300 |
| 305 | | | | | | | | | | | | | | | | | 2.2 | | | | | | | | | 305 |

* adapter - pièce d'adaptateur

t_240_003_50701_00_000 / 52701_00_000 / 54701_00_000

Lifting capacities Forces de levage

TF



| ft | 48 + 6.6 ft* | | | 144 + 6.6 ft* | | | 160 + 6.6 ft* | | | 176 + 6.6 ft* | | | 192 + 6.6 ft* | | | 208 + 6.6 ft* | | | 224 + 6.6 ft* | | | 240 + 6.6 ft* | | | ft |
|-----|--------------|-----|-----|---------------|-----|-----|---------------|-----|-----|---------------|-----|-----|---------------|-----|-----|---------------|-----|-----|---------------|-----|-----|---------------|-----|-----|-----|
| | 126 ft | | | 126 ft | | | 126 ft | | | 126 ft | | | 126 ft | | | 126 ft | | | 126 ft | | | 126 ft | | | |
| | 0° | 20° | 40° | 0° | 20° | 40° | 0° | 20° | 40° | 0° | 20° | 40° | 0° | 20° | 40° | 0° | 20° | 40° | 0° | 20° | 40° | 0° | 20° | 40° | |
| 28 | 16.7 | | | | | | | | | | | | | | | | | | | | | | | 28 | |
| 30 | 16.4 | | | | | | | | | | | | | | | | | | | | | | | 30 | |
| 32 | 16 | | | | | | | | | | | | | | | | | | | | | | | 32 | |
| 34 | 15.6 | | | | | | | | | | | | | | | | | | | | | | | 34 | |
| 36 | 15.2 | | | | | | | | | | | | | | | | | | | | | | | 36 | |
| 38 | 14.8 | | | | | | | | | | | | | | | | | | | | | | | 38 | |
| 40 | 14.5 | | | | | | | | | | | | | | | | | | | | | | | 40 | |
| 45 | 13.6 | | | | | | | | | | | | | | | | | | | | | | | 45 | |
| 50 | 12.8 | | | 16.2 | | | 15.3 | | | | | | | | | | | | | | | | | 50 | |
| 55 | 12 | | | 15.5 | | | 14.9 | | | | | | | | | | | | | | | | | 55 | |
| 60 | 11.3 | | | 14.9 | | | 14.3 | | | 13.5 | | | | | | | | | | | | | | 60 | |
| 65 | 10.6 | | | 14.3 | | | 13.8 | | | 13.1 | | | 12.1 | | | | | | | | | | | 65 | |
| 70 | 9.9 | 8.1 | | 13.7 | | | 13.3 | | | 12.6 | | | 11.7 | | | 10.6 | | | | | | | | 70 | |
| 75 | 9.2 | 7.8 | | 13.2 | | | 12.8 | | | 12.2 | | | 11.4 | | | 10.4 | | | 8.1 | | | | | 75 | |
| 80 | 8.7 | 7.3 | | 12.6 | | | 12.4 | | | 11.8 | | | 11.1 | | | 10.1 | | | 8 | | | 5.5 | | 80 | |
| 85 | 8.1 | 7 | | 12.1 | | | 11.9 | | | 11.5 | | | 10.8 | | | 9.8 | | | 7.9 | | | 5.5 | | 85 | |
| 90 | 7.6 | 6.6 | | 11.6 | | | 11.5 | | | 11.1 | | | 10.4 | | | 9.5 | | | 7.7 | | | 5.5 | | 90 | |
| 95 | 7.3 | 6.3 | | 11.2 | 7.8 | | 11 | | | 10.7 | | | 10.1 | | | 9.2 | | | 7.6 | | | 5.5 | | 95 | |
| 100 | 6.9 | 6 | | 10.7 | 7.5 | | 10.6 | 7.5 | | 10.3 | | | 9.8 | | | 8.9 | | | 7.5 | | | 5.5 | | 100 | |
| 105 | 6.5 | 5.7 | 4.9 | 10.3 | 7.3 | | 10.2 | 7.2 | | 10 | 7.1 | | 9.5 | | | 8.7 | | | 7.4 | | | 5.6 | | 105 | |
| 110 | 6.2 | 5.4 | 4.7 | 9.8 | 7 | | 9.8 | 7 | | 9.6 | 6.9 | | 9.2 | 6.8 | | 8.4 | | | 7.3 | | | 5.6 | | 110 | |
| 115 | 5.9 | 5.2 | 4.5 | 9.4 | 6.8 | | 9.5 | 6.8 | | 9.3 | 6.7 | | 8.8 | 6.6 | | 8.2 | | | 7.2 | | | 5.5 | | 115 | |
| 120 | 5.6 | 5 | 4.4 | 9 | 6.6 | | 9.1 | 6.6 | | 8.9 | 6.5 | | 8.5 | 6.4 | | 7.9 | 6.1 | | 7.1 | | | 5.4 | | 120 | |
| 125 | 5.3 | 4.8 | 4.2 | 8.6 | 6.3 | 4.9 | 8.7 | 6.4 | | 8.6 | 6.4 | | 8.3 | 6.3 | | 7.7 | 6 | | 6.9 | | | 5.3 | | 125 | |
| 130 | 5 | 4.6 | 4.1 | 8.3 | 6.2 | 4.8 | 8.4 | 6.2 | 4.8 | 8.3 | 6.2 | | 8 | 6.1 | | 7.5 | 5.9 | | 6.8 | 5.5 | | 5.2 | | 130 | |
| 135 | 4.8 | 4.4 | 4 | 7.9 | 6 | 4.6 | 8.1 | 6 | 4.6 | 8 | 6 | 4.6 | 7.8 | 5.9 | | 7.3 | 5.7 | | 6.7 | 5.4 | | 5.1 | 4.7 | 135 | |
| 140 | 4.6 | 4.2 | 3.9 | 7.6 | 5.8 | 4.6 | 7.8 | 5.9 | 4.6 | 7.7 | 5.8 | 4.5 | 7.5 | 5.8 | 4.4 | 7.1 | 5.6 | | 6.5 | 5.3 | | 4.9 | 4.6 | 140 | |
| 145 | 4.4 | 4.1 | 3.8 | 7.4 | 5.6 | 4.5 | 7.5 | 5.7 | 4.5 | 7.5 | 5.7 | 4.4 | 7.3 | 5.6 | 4.4 | 6.9 | 5.5 | | 6.4 | 5.2 | | 4.8 | 4.5 | 145 | |
| 150 | 4.2 | 4 | 3.7 | 7.1 | 5.5 | 4.4 | 7.2 | 5.5 | 4.4 | 7.3 | 5.6 | 4.4 | 7 | 5.5 | 4.3 | 6.8 | 5.4 | 4.2 | 6.2 | 5.1 | | 4.6 | 4.3 | 150 | |
| 155 | 4 | 3.9 | 3.7 | 6.9 | 5.3 | 4.3 | 7 | 5.4 | 4.3 | 7 | 5.4 | 4.3 | 6.9 | 5.4 | 4.2 | 6.6 | 5.2 | 4.2 | 6.1 | 5 | | 4.5 | 4.2 | 155 | |
| 160 | 3.8 | 3.8 | 3.7 | 6.7 | 5.2 | 4.2 | 6.8 | 5.3 | 4.2 | 6.8 | 5.3 | 4.2 | 6.7 | 5.2 | 4.2 | 6.4 | 5.1 | 4.1 | 6 | 4.9 | 4 | 4.3 | 4 | 160 | |
| 165 | 3.7 | 3.8 | 3.7 | 6.4 | 5 | 4.1 | 6.6 | 5.1 | 4.1 | 6.6 | 5.2 | 4.1 | 6.5 | 5.1 | 4.1 | 6.3 | 5 | 4 | 5.9 | 4.8 | 3.9 | 4.2 | 3.9 | 165 | |
| 170 | 3.6 | 3.8 | | 6.2 | 4.9 | 4.1 | 6.4 | 5 | 4.1 | 6.4 | 5 | 4.1 | 6.4 | 5 | 4 | 6.1 | 4.9 | 4 | 5.7 | 4.7 | 3.9 | 4 | 3.8 | 3.8 | 170 |
| 175 | | | | 6 | 4.8 | 4 | 6.2 | 4.9 | 4 | 6.3 | 4.9 | 4 | 6.2 | 4.9 | 4 | 6 | 4.8 | 3.9 | 5.6 | 4.6 | 3.8 | 3.9 | 3.7 | 3.7 | 175 |
| 180 | | | | 5.8 | 4.7 | 3.9 | 6 | 4.8 | 4 | 6.1 | 4.8 | 4 | 6 | 4.8 | 3.9 | 5.9 | 4.7 | 3.9 | 5.5 | 4.6 | 3.8 | 3.8 | 3.5 | 3.6 | 180 |
| 185 | | | | 5.6 | 4.6 | 3.9 | 5.9 | 4.7 | 3.9 | 6 | 4.7 | 3.9 | 5.9 | 4.7 | 3.9 | 5.7 | 4.6 | 3.8 | 5.4 | 4.5 | 3.7 | 3.6 | 3.4 | 3.4 | 185 |
| 190 | | | | 5.5 | 4.5 | 3.8 | 5.7 | 4.6 | 3.9 | 5.8 | 4.6 | 3.9 | 5.8 | 4.6 | 3.8 | 5.6 | 4.5 | 3.8 | 5.2 | 4.4 | 3.7 | 3.5 | 3.3 | 3.3 | 190 |
| 195 | | | | 5.3 | 4.4 | 3.8 | 5.5 | 4.5 | 3.8 | 5.6 | 4.5 | 3.8 | 5.6 | 4.5 | 3.8 | 5.5 | 4.4 | 3.8 | 5.1 | 4.3 | 3.7 | 3.4 | 3.1 | 3.2 | 195 |
| 200 | | | | 5.1 | 4.3 | 3.8 | 5.3 | 4.4 | 3.8 | 5.5 | 4.4 | 3.8 | 5.5 | 4.4 | 3.8 | 5.4 | 4.4 | 3.7 | 4.9 | 4.2 | 3.7 | 3.2 | 3 | 3.1 | 200 |
| 205 | | | | 4.9 | 4.2 | 3.7 | 5.2 | 4.3 | 3.7 | 5.3 | 4.3 | 3.7 | 5.4 | 4.3 | 3.7 | 5.2 | 4.3 | 3.7 | 4.8 | 4.2 | 3.6 | 3.1 | 2.9 | 3 | 205 |
| 210 | | | | 4.8 | 4.1 | 3.7 | 5 | 4.2 | 3.7 | 5.2 | 4.2 | 3.7 | 5.2 | 4.3 | 3.7 | 5.1 | 4.2 | 3.7 | 4.7 | 4.1 | 3.6 | 3 | 2.8 | 2.9 | 210 |
| 215 | | | | 4.6 | 4 | 3.7 | 4.9 | 4.1 | 3.7 | 5 | 4.2 | 3.7 | 5.1 | 4.2 | 3.7 | 5 | 4.1 | 3.6 | 4.5 | 4 | 3.6 | 2.8 | 2.6 | 2.8 | 215 |
| 220 | | | | 4.5 | 4 | 3.7 | 4.7 | 4.1 | 3.7 | 4.9 | 4.1 | 3.7 | 5 | 4.1 | 3.6 | 4.9 | 4.1 | 3.6 | 4.3 | 4 | 3.6 | 2.7 | 2.5 | 2.7 | 220 |
| 225 | | | | 4.3 | 3.9 | 3.7 | 4.6 | 4 | 3.7 | 4.7 | 4 | 3.7 | 4.8 | 4 | 3.6 | 4.8 | 4 | 3.6 | 4.2 | 3.9 | 3.6 | 2.6 | 2.4 | 2.6 | 225 |
| 230 | | | | 4.2 | 3.9 | 3.7 | 4.5 | 3.9 | 3.7 | 4.6 | 4 | 3.6 | 4.7 | 4 | 3.6 | 4.7 | 4 | 3.6 | 4 | 3.9 | 3.5 | 2.5 | 2.3 | 2.4 | 230 |
| 235 | | | | 4.1 | 3.8 | 3.7 | 4.3 | 3.9 | 3.7 | 4.5 | 3.9 | 3.6 | 4.6 | 3.9 | 3.6 | 4.6 | 3.9 | 3.6 | 3.8 | 3.8 | 3.5 | 2.4 | 2.2 | 2.3 | 235 |
| 240 | | | | 4 | 3.8 | 3.7 | 4.2 | 3.8 | 3.7 | 4.4 | 3.9 | 3.6 | 4.5 | 3.9 | 3.6 | 4.5 | 3.9 | 3.6 | 3.6 | 3.7 | 3.5 | 2.2 | | 2.3 | 240 |
| 245 | | | | 3.9 | 3.8 | 3.7 | 4.1 | 3.8 | 3.7 | 4.3 | 3.8 | 3.6 | 4.4 | 3.8 | 3.6 | 4.3 | 3.8 | 3.6 | 3.5 | 3.6 | 3.5 | 2.1 | | 2.2 | 245 |
| 250 | | | | 3.8 | 3.8 | | 4 | 3.8 | 3.7 | 4.2 | 3.8 | 3.6 | 4.3 | 3.8 | 3.6 | 4.2 | 3.8 | 3.6 | 3.3 | 3.6 | 3.5 | | | | 250 |
| 255 | | | | 3.7 | 3.8 | | 3.9 | 3.8 | 3.7 | 4.1 | 3.7 | 3.6 | 4.2 | 3.8 | 3.6 | 4.1 | 3.7 | 3.6 | 3.1 | 3.4 | 3.5 | | | | 255 |
| 260 | | | | 3.6 | 3.8 | | 3.8 | 3.8 | 3.7 | 4 | 3.7 | 3.6 | 4.1 | 3.7 | 3.6 | 3.9 | 3.7 | 3.6 | 3 | 3.3 | 3.5 | | | | 260 |
| 265 | | | | 2.8 | 3.8 | | 3.7 | 3.8 | | 3.9 | 3.7 | 3.6 | 4 | 3.7 | 3.6 | 3.7 | 3.6 | 3.6 | 2.8 | 3.1 | 3.4 | | | | 265 |
| 270 | | | | | | | 3.6 | 3.8 | | 3.8 | 3.7 | 3.6 | 3.7 | 3.7 | 3.6 | 3.3 | 3.6 | 3.6 | 2.6 | 3 | 3.3 | | | | 270 |
| 275 | | | | | | | 3.5 | 3.8 | | 3.7 | 3.7 | | 3.6 | 3.7 | 3.6 | 2.9 | 3.5 | 3.6 | 2.5 | 2.8 | 3.1 | | | | 275 |
| 280 | | | | | | | | 3.5 | | 3.6 | 3.7 | | 3.4 | 3.7 | 3.6 | 2.5 | 3.5 | 3.6 | | 2.7 | 3 | | | | 280 |
| 285 | | | | | | | | | | 3.3 | 3.7 | | 3.2 | 3.5 | 3.6 | 2.2 | 3.3 | 3.5 | | 2.5 | 2.8 | | | | 285 |
| 290 | | | | | | | | | | | 3.7 | | 3 | 3.3 | | | 2.9 | 3.2 | | 2.3 | 2.6 | | | | 290 |
| 295 | | | | | | | | | | | | | 2.7 | 3.1 | | | 2.3 | 2.7 | | | 2.4 | | | | 295 |
| 300 | | | | | | | | | | | | | | 2.9 | | | | | | | | | | | 300 |
| 305 | | | | | | | | | | | | | | 2.4 | | | | | | | | | | | 305 |

* adapter - pièce d'adaptateur

t_240_003_50801_00_000 / 52801_00_000 / 54801_00_000

Lifting capacities Forces de levage

TF



| ft | 48 + 6.6 ft* | | | 144 + 6.6 ft* | | | 160 + 6.6 ft* | | | 176 + 6.6 ft* | | | 192 + 6.6 ft* | | | 208 + 6.6 ft* | | | 224 + 6.6 ft* | | | 240 + 6.6 ft* | | | ft |
|-----|--------------|-----|-----|---------------|-----|-----|---------------|-----|-----|---------------|-----|-----|---------------|-----|-----|---------------|-----|-----|---------------|-----|-----|---------------|-----|-----|-----|
| | 138 ft | | | 138 ft | | | 138 ft | | | 138 ft | | | 138 ft | | | 138 ft | | | 138 ft | | | 138 ft | | | |
| | 0° | 20° | 40° | 0° | 20° | 40° | 0° | 20° | 40° | 0° | 20° | 40° | 0° | 20° | 40° | 0° | 20° | 40° | 0° | 20° | 40° | 0° | 20° | 40° | |
| 30 | 14.2 | | | | | | | | | | | | | | | | | | | | | | | 30 | |
| 32 | 14 | | | | | | | | | | | | | | | | | | | | | | | 32 | |
| 34 | 13.7 | | | | | | | | | | | | | | | | | | | | | | | 34 | |
| 36 | 13.4 | | | | | | | | | | | | | | | | | | | | | | | 36 | |
| 38 | 13.1 | | | | | | | | | | | | | | | | | | | | | | | 38 | |
| 40 | 12.7 | | | | | | | | | | | | | | | | | | | | | | | 40 | |
| 45 | 12 | | | | | | | | | | | | | | | | | | | | | | | 45 | |
| 50 | 11.3 | | | 14 | | | | | | | | | | | | | | | | | | | | 50 | |
| 55 | 10.6 | | | 13.5 | | | 12.9 | | | | | | | | | | | | | | | | | 55 | |
| 60 | 10 | | | 13 | | | 12.5 | | | 11.7 | | | | | | | | | | | | | | 60 | |
| 65 | 9.4 | | | 12.4 | | | 12 | | | 11.4 | | | 10.5 | | | | | | | | | | | 65 | |
| 70 | 8.8 | | | 11.9 | | | 11.6 | | | 11 | | | 10.2 | | | | | | | | | | | 70 | |
| 75 | 8.2 | | | 11.5 | | | 11.1 | | | 10.6 | | | 9.9 | | | 8.9 | | | | | | | | 75 | |
| 80 | 7.6 | 6.5 | | 11 | | | 10.7 | | | 10.2 | | | 9.6 | | | 8.7 | | | 6.9 | | | | | 80 | |
| 85 | 7.2 | 6.2 | | 10.6 | | | 10.4 | | | 9.9 | | | 9.3 | | | 8.5 | | | 6.9 | | | 4.2 | | 85 | |
| 90 | 6.8 | 5.8 | | 10.1 | | | 10 | | | 9.6 | | | 9 | | | 8.2 | | | 6.8 | | | 4.2 | | 90 | |
| 95 | 6.5 | 5.5 | | 9.7 | | | 9.6 | | | 9.3 | | | 8.7 | | | 8 | | | 6.7 | | | 4.2 | | 95 | |
| 100 | 6.1 | 5.2 | | 9.3 | 6.5 | | 9.2 | | | 8.9 | | | 8.5 | | | 7.7 | | | 6.6 | | | 4.3 | | 100 | |
| 105 | 5.8 | 5 | | 8.9 | 6.3 | | 8.9 | 6.3 | | 8.6 | | | 8.2 | | | 7.5 | | | 6.6 | | | 4.3 | | 105 | |
| 110 | 5.5 | 4.7 | | 8.5 | 6.1 | | 8.5 | 6.1 | | 8.3 | 6 | | 7.9 | | | 7.2 | | | 6.5 | | | 4.3 | | 110 | |
| 115 | 5.2 | 4.5 | 3.9 | 8.2 | 5.8 | | 8.2 | 5.9 | | 8 | 5.8 | | 7.6 | | | 7 | | | 6.3 | | | 4.3 | | 115 | |
| 120 | 4.9 | 4.3 | 3.7 | 7.8 | 5.6 | | 7.8 | 5.7 | | 7.7 | 5.6 | | 7.3 | 5.5 | | 6.8 | | | 6.2 | | | 4.3 | | 120 | |
| 125 | 4.7 | 4.1 | 3.6 | 7.5 | 5.5 | | 7.5 | 5.5 | | 7.5 | 5.5 | | 7.1 | 5.4 | | 6.7 | 5.2 | | 6 | | | 4.2 | | 125 | |
| 130 | 4.5 | 3.9 | 3.4 | 7.2 | 5.3 | | 7.2 | 5.3 | | 7.2 | 5.3 | | 6.9 | 5.2 | | 6.5 | 5 | | 5.9 | | | 4.2 | | 130 | |
| 135 | 4.2 | 3.8 | 3.3 | 6.9 | 5.1 | 3.6 | 7 | 5.1 | | 6.9 | 5.1 | | 6.7 | 5 | | 6.3 | 4.9 | | 5.8 | 4.6 | | 4.1 | | 135 | |
| 140 | 4 | 3.6 | 3.2 | 6.7 | 5 | 3.6 | 6.7 | 5 | 3.6 | 6.7 | 5 | | 6.5 | 4.9 | | 6.1 | 4.8 | | 5.6 | 4.5 | | 4 | | 140 | |
| 145 | 3.9 | 3.5 | 3.1 | 6.5 | 4.8 | 3.5 | 6.5 | 4.9 | 3.5 | 6.5 | 4.8 | 3.4 | 6.3 | 4.8 | | 6 | 4.6 | | 5.5 | 4.4 | | 3.9 | 3.7 | 145 | |
| 150 | 3.7 | 3.3 | 3 | 6.2 | 4.6 | 3.4 | 6.3 | 4.7 | 3.4 | 6.3 | 4.7 | 3.4 | 6.1 | 4.6 | 3.3 | 5.8 | 4.5 | | 5.4 | 4.3 | | 3.8 | 3.6 | 150 | |
| 155 | 3.5 | 3.2 | 2.9 | 6 | 4.5 | 3.3 | 6.1 | 4.6 | 3.3 | 6.1 | 4.6 | 3.3 | 6 | 4.5 | 3.2 | 5.7 | 4.4 | | 5.3 | 4.2 | | 3.7 | 3.4 | 155 | |
| 160 | 3.3 | 3.1 | 2.9 | 5.8 | 4.4 | 3.3 | 5.9 | 4.4 | 3.3 | 5.9 | 4.5 | 3.2 | 5.8 | 4.4 | 3.2 | 5.5 | 4.3 | 3.1 | 5.2 | 4.1 | | 3.5 | 3.3 | 160 | |
| 165 | 3.2 | 3 | 2.9 | 5.6 | 4.2 | 3.2 | 5.7 | 4.3 | 3.2 | 5.8 | 4.3 | 3.2 | 5.6 | 4.3 | 3.2 | 5.4 | 4.2 | 3.1 | 5 | 4 | | 3.4 | 3.1 | 165 | |
| 170 | 3 | 3 | 2.9 | 5.4 | 4.1 | 3.1 | 5.5 | 4.2 | 3.2 | 5.6 | 4.2 | 3.1 | 5.5 | 4.2 | 3.1 | 5.2 | 4.1 | 3 | 4.9 | 3.9 | 2.9 | 3.3 | 3 | 170 | |
| 175 | 2.9 | 2.9 | 2.9 | 5.2 | 4 | 3.1 | 5.4 | 4.1 | 3.1 | 5.4 | 4.1 | 3.1 | 5.3 | 4.1 | 3.1 | 5.1 | 4 | 3 | 4.8 | 3.8 | 2.8 | 3.1 | 2.9 | 175 | |
| 180 | 2.8 | 2.9 | | 5 | 3.9 | 3 | 5.2 | 4 | 3.1 | 5.3 | 4 | 3 | 5.2 | 4 | 3 | 5 | 3.9 | 2.9 | 4.7 | 3.8 | 2.8 | 3 | 2.7 | 2.7 | 180 |
| 185 | 2.8 | | | 4.9 | 3.8 | 3 | 5 | 3.9 | 3 | 5.1 | 3.9 | 3 | 5 | 3.9 | 3 | 4.9 | 3.8 | 2.9 | 4.6 | 3.7 | 2.8 | 2.8 | 2.6 | 2.6 | 185 |
| 190 | | | | 4.7 | 3.7 | 2.9 | 4.9 | 3.8 | 3 | 5 | 3.8 | 3 | 4.9 | 3.8 | 2.9 | 4.8 | 3.7 | 2.9 | 4.5 | 3.6 | 2.8 | 2.7 | 2.5 | 2.6 | 190 |
| 195 | | | | 4.5 | 3.6 | 2.9 | 4.7 | 3.7 | 2.9 | 4.8 | 3.7 | 2.9 | 4.8 | 3.7 | 2.9 | 4.7 | 3.6 | 2.9 | 4.4 | 3.5 | 2.8 | 2.5 | 2.3 | 2.5 | 195 |
| 200 | | | | 4.4 | 3.5 | 2.9 | 4.6 | 3.6 | 2.9 | 4.7 | 3.6 | 2.9 | 4.7 | 3.6 | 2.9 | 4.5 | 3.6 | 2.8 | 4.3 | 3.5 | 2.7 | 2.4 | 2.2 | 2.4 | 200 |
| 205 | | | | 4.2 | 3.4 | 2.9 | 4.4 | 3.5 | 2.9 | 4.5 | 3.5 | 2.9 | 4.6 | 3.5 | 2.9 | 4.4 | 3.5 | 2.8 | 4.2 | 3.4 | 2.7 | 2.3 | | 2.3 | 205 |
| 210 | | | | 4.1 | 3.4 | 2.9 | 4.3 | 3.4 | 2.9 | 4.4 | 3.5 | 2.9 | 4.4 | 3.5 | 2.8 | 4.3 | 3.4 | 2.8 | 4.1 | 3.3 | 2.7 | 2.2 | | 2.1 | 210 |
| 215 | | | | 4 | 3.3 | 2.9 | 4.2 | 3.4 | 2.8 | 4.3 | 3.4 | 2.9 | 4.3 | 3.4 | 2.8 | 4.2 | 3.4 | 2.8 | 4 | 3.3 | 2.7 | | | | 215 |
| 220 | | | | 3.8 | 3.2 | 2.9 | 4 | 3.3 | 2.8 | 4.2 | 3.3 | 2.9 | 4.2 | 3.3 | 2.8 | 4.1 | 3.3 | 2.8 | 3.9 | 3.2 | 2.7 | | | | 220 |
| 225 | | | | 3.7 | 3.2 | 2.9 | 3.9 | 3.2 | 2.8 | 4 | 3.3 | 2.8 | 4.1 | 3.3 | 2.8 | 4.1 | 3.2 | 2.8 | 3.7 | 3.2 | 2.7 | | | | 225 |
| 230 | | | | 3.6 | 3.1 | 2.9 | 3.8 | 3.2 | 2.8 | 3.9 | 3.2 | 2.8 | 4 | 3.2 | 2.8 | 4 | 3.2 | 2.8 | 3.5 | 3.1 | 2.7 | | | | 230 |
| 235 | | | | 3.5 | 3 | 2.9 | 3.7 | 3.1 | 2.8 | 3.8 | 3.1 | 2.8 | 3.9 | 3.1 | 2.8 | 3.9 | 3.1 | 2.8 | 3.4 | 3 | 2.7 | | | | 235 |
| 240 | | | | 3.4 | 3 | 2.9 | 3.6 | 3.1 | 2.8 | 3.7 | 3.1 | 2.8 | 3.8 | 3.1 | 2.8 | 3.8 | 3.1 | 2.8 | 3.2 | 3 | 2.7 | | | | 240 |
| 245 | | | | 3.3 | 3 | 2.9 | 3.5 | 3 | 2.8 | 3.6 | 3 | 2.8 | 3.7 | 3.1 | 2.8 | 3.7 | 3 | 2.7 | 3.1 | 3 | 2.7 | | | | 245 |
| 250 | | | | 3.2 | 2.9 | 2.9 | 3.4 | 3 | 2.8 | 3.5 | 3 | 2.8 | 3.6 | 3 | 2.8 | 3.6 | 3 | 2.7 | 2.9 | 2.9 | 2.7 | | | | 250 |
| 255 | | | | 3.1 | 2.9 | 2.9 | 3.3 | 2.9 | 2.8 | 3.4 | 3 | 2.8 | 3.5 | 3 | 2.8 | 3.5 | 3 | 2.7 | 2.8 | 2.9 | 2.7 | | | | 255 |
| 260 | | | | 3 | 2.9 | | 3.2 | 2.9 | 2.8 | 3.3 | 2.9 | 2.8 | 3.4 | 2.9 | 2.8 | 3.4 | 2.9 | 2.7 | 2.6 | 2.8 | 2.7 | | | | 260 |
| 265 | | | | 2.9 | 2.9 | | 3.1 | 2.9 | 2.8 | 3.2 | 2.9 | 2.8 | 3.3 | 2.9 | 2.8 | 3.3 | 2.9 | 2.7 | 2.5 | 2.8 | 2.7 | | | | 265 |
| 270 | | | | 2.8 | 2.9 | | 3 | 2.9 | 2.8 | 3.2 | 2.9 | 2.8 | 3.3 | 2.9 | 2.8 | 3.2 | 2.8 | 2.7 | | 2.6 | 2.7 | | | | 270 |
| 275 | | | | 2.8 | 2.9 | | 2.9 | 2.9 | | 3.1 | 2.9 | 2.8 | 3.2 | 2.8 | 2.8 | 3 | 2.8 | 2.7 | | 2.5 | 2.7 | | | | 275 |
| 280 | | | | | | | 2.9 | 2.9 | | 3 | 2.8 | 2.8 | 3.1 | 2.8 | 2.8 | 2.7 | 2.8 | 2.7 | | 2.3 | 2.6 | | | | 280 |
| 285 | | | | | | | 2.8 | 2.9 | | 2.9 | 2.8 | 2.8 | 2.9 | 2.8 | 2.8 | 2.3 | 2.8 | 2.7 | | 2.2 | 2.5 | | | | 285 |
| 290 | | | | | | | | 2.9 | | 2.9 | 2.8 | | 2.8 | 2.8 | 2.8 | | 2.8 | 2.7 | | | 2.4 | | | | 290 |
| 295 | | | | | | | | | | 2.8 | 2.8 | | 2.6 | 2.8 | 2.8 | | 2.7 | 2.7 | | | 2.2 | | | | 295 |
| 300 | | | | | | | | | | | 2.8 | | 2.4 | 2.7 | | | 2.3 | 2.6 | | | | | | | 300 |
| 305 | | | | | | | | | | | 2.2 | | 2.1 | 2.5 | | | 2.2 | | | | | | | | 305 |
| 310 | | | | | | | | | | | | | | 2.3 | | | | | | | | | | | 310 |

* adapter - pièce d'adaptateur

t_240_003_50901_00_000 / 52901_00_000 / 54901_00_000

Lifting heights Hauteurs de levage

TF

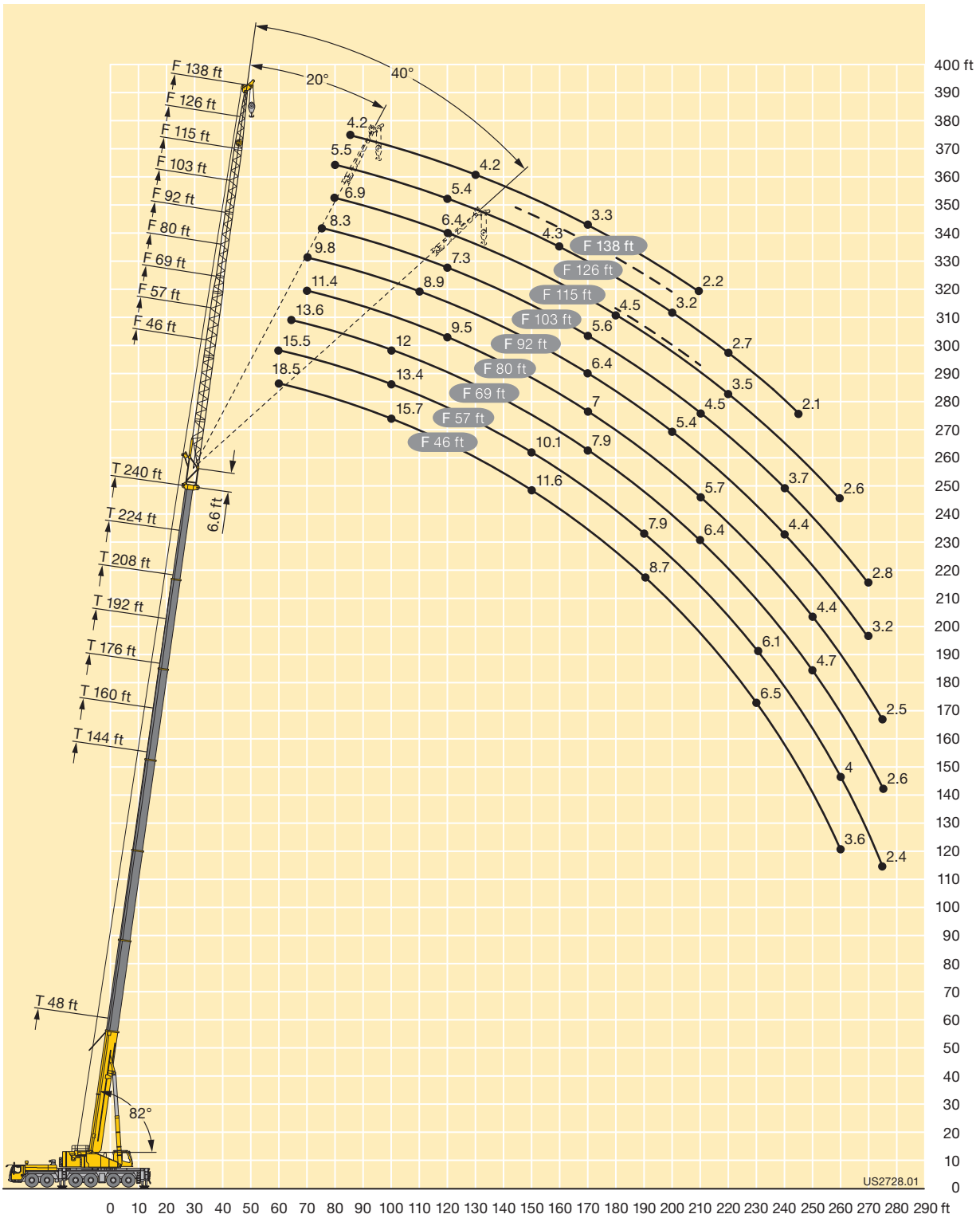

Lifting capacities Forces de levage

TN



| ft | 48 + 11.5 ft* | | | 64 + 11.5 ft* | | | 80 + 11.5 ft* | | | 96 + 11.5 ft* | | | 112 + 11.5 ft* | | | ft |
|-----|---------------|-------|------|---------------|-------|------|---------------|------|------|---------------|------|------|----------------|------|------|-----|
| | 57 ft | | | 57 ft | | | 57 ft | | | 57 ft | | | 57 ft | | | |
| | 82° | 75° | 68° | 82° | 75° | 68° | 82° | 75° | 68° | 82° | 75° | 68° | 82° | 75° | 68° | |
| 26 | 110.7 | | | | | | | | | | | | | | | 26 |
| 28 | 110.8 | | | | | | | | | | | | | | | 28 |
| 30 | 110.7 | | | 103.2 | | | | | | | | | | | | 30 |
| 32 | 110.3 | | | 103.9 | | | 93.9 | | | | | | | | | 32 |
| 34 | 109.3 | | | 104.4 | | | 94.2 | | | 82.8 | | | | | | 34 |
| 36 | 108 | | | 104.8 | | | 94.4 | | | 82.8 | | | | | | 36 |
| 38 | 107 | | | 104.9 | | | 94.4 | | | 82.7 | | | 70.8 | | | 38 |
| 40 | 106.1 | 105.1 | | 104.6 | | | 94.4 | | | 82.6 | | | 70.7 | | | 40 |
| 45 | 103.5 | 98.5 | | 102.5 | 100.6 | | 94.4 | | | 82.6 | | | 70.7 | | | 45 |
| 50 | 95.6 | 93.2 | | 100.2 | 97.6 | | 94.4 | 91.4 | | 82.6 | | | 70.7 | | | 50 |
| 55 | 83.9 | 89.5 | 86.2 | 90.4 | 94.6 | | 93 | 91.1 | | 82.6 | 79.8 | | 70.7 | | | 55 |
| 60 | 65.5 | 86.5 | 81.6 | 79 | 91.7 | 89.2 | 85.4 | 89.9 | | 82.6 | 79.9 | | 70.7 | 68.2 | | 60 |
| 65 | | 78.8 | 78.3 | | 88 | 84.7 | 72.9 | 88.8 | | 80.5 | 80.4 | | 70.7 | 68.2 | | 65 |
| 70 | | | 77.2 | | 78.3 | 81.6 | | 86.3 | 81.7 | | 80.8 | | 70.7 | 68.2 | | 70 |
| 75 | | | 72.9 | | | 79 | | 78 | 75.9 | | 78.5 | 73.1 | | 68.2 | | 75 |
| 80 | | | | | | 73.7 | | | 70.7 | | 73.2 | 68.2 | | 68.2 | | 80 |
| 85 | | | | | | | | | 66 | | | 63.7 | | 65.9 | 60.1 | 85 |
| 90 | | | | | | | | | | | | 59.7 | | | 56.4 | 90 |
| 95 | | | | | | | | | | | | | | | 53 | 95 |
| 100 | | | | | | | | | | | | | | | 49.9 | 100 |

* adapter · pièce d'adaptateur

t_240_004_50101_00_000

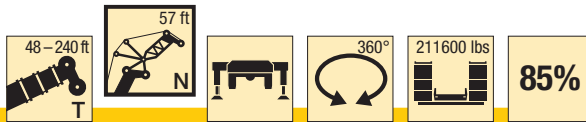

| ft | 128 + 11.5 ft* | | | 144 + 11.5 ft* | | | 160 + 11.5 ft* | | | 176 + 11.5 ft* | | 192 + 11.5 ft* | | 208 + 11.5 ft | 224 + 11.5 ft | 240 + 11.5 ft | ft |
|-----|----------------|------|------|----------------|------|------|----------------|------|-----|----------------|------|----------------|------|---------------|---------------|---------------|-----|
| | 57 ft | | | 57 ft | | | 57 ft | | | 57 ft | | 57 ft | | 57 ft | 57 ft | 57 ft | |
| | 82° | 75° | 68° | 82° | 75° | 68° | 82° | 75° | 68° | 82° | 75° | 82° | 75° | 82° | 82° | 82° | |
| 40 | 60.7 | | | | | | | | | | | | | | | | 40 |
| 45 | 60.6 | | | 49.7 | | | | | | | | | | | | | 45 |
| 50 | 60.5 | | | 49.6 | | | 39.3 | | | | | | | | | | 50 |
| 55 | 60.5 | | | 49.6 | | | 39.2 | | | 32.2 | | 25 | | | | | 55 |
| 60 | 60.5 | | | 49.6 | | | 39 | | | 32.1 | | 24.9 | | 18.7 | | | 60 |
| 65 | 60.5 | 58.4 | | 49.6 | | | 38.9 | | | 32 | | 24.9 | | 18.7 | 12.7 | 7.7 | 65 |
| 70 | 60.5 | 58.5 | | 49.6 | | | 38.9 | | | 31.9 | | 24.8 | | 18.6 | 12.6 | 7.6 | 70 |
| 75 | | 58.8 | | 49.6 | 48 | | 38.9 | | | 31.9 | | 24.8 | | 18.5 | 12.4 | 7.4 | 75 |
| 80 | | 59.1 | | | 48.1 | | | 37.8 | | | | 24.8 | | 18.4 | 12.3 | 7.3 | 80 |
| 85 | | 59.1 | | | 48 | | | 37.6 | | | 30.3 | | | | 12.2 | 7.2 | 85 |
| 90 | | 59 | 54.3 | | 47 | | | 37.4 | | | 30.2 | | | | | | 90 |
| 95 | | | 51.1 | | | | | 37.3 | | | 30 | | 23.2 | | | | 95 |
| 100 | | | 48.2 | | | 40.6 | | | | | 29.9 | | 23.1 | | | | 100 |
| 105 | | | 45.5 | | | 39.2 | | | | 33 | | | 22.9 | | | | 105 |
| 110 | | | | | | 37.9 | | | | 31.8 | | | | | | | 110 |
| 115 | | | | | | | | | | 30.9 | | | | | | | 115 |

* adapter · pièce d'adaptateur

t_240_004_50101_00_000

Lifting capacities Forces de levage

TN



| ft | 48 + 11.5 ft* | | | 64 + 11.5 ft* | | | 80 + 11.5 ft* | | | 96 + 11.5 ft* | | | 112 + 11.5 ft* | | | ft |
|-----|---------------|------|------|---------------|------|------|---------------|------|------|---------------|------|------|----------------|------|------|-----|
| | 69 ft | | | 69 ft | | | 69 ft | | | 69 ft | | | 69 ft | | | |
| | 82° | 75° | 68° | 82° | 75° | 68° | 82° | 75° | 68° | 82° | 75° | 68° | 82° | 75° | 68° | |
| 30 | 97.7 | | | | | | | | | | | | | | | 30 |
| 32 | 97.6 | | | 91.4 | | | | | | | | | | | | 32 |
| 34 | 97.1 | | | 91.5 | | | | | | | | | | | | 34 |
| 36 | 96.2 | | | 91.6 | | | 83.4 | | | | | | | | | 36 |
| 38 | 95.1 | | | 91.4 | | | 83.2 | | | 73.4 | | | | | | 38 |
| 40 | 94 | | | 91.1 | | | 83.1 | | | 73.4 | | | | | | 40 |
| 45 | 91.5 | 90.3 | | 89.5 | | | 82.8 | | | 73.1 | | | 63.4 | | | 45 |
| 50 | 89.4 | 86.9 | | 87.9 | 86.8 | | 82.6 | | | 73 | | | 63.3 | | | 50 |
| 55 | 87.9 | 83 | | 86.8 | 84.4 | | 82.3 | 80.5 | | 73 | | | 63.3 | | | 55 |
| 60 | 83.7 | 79.6 | 77.8 | 85.6 | 82.5 | | 81.9 | 79.2 | | 73 | 70.9 | | 63.3 | | | 60 |
| 65 | 73.7 | 77.3 | 73.7 | 81.2 | 80.8 | 79.3 | 81.9 | 77.7 | | 73 | 70.8 | | 63.3 | 61.3 | | 65 |
| 70 | 57.8 | 75.9 | 70.6 | 69.3 | 79.6 | 76.3 | 77 | 76.6 | | 73 | 70.5 | | 63.3 | 61.2 | | 70 |
| 75 | | 70.6 | 68.3 | 51.8 | 79.2 | 73.6 | 64.4 | 76 | 74.2 | 73 | 69.9 | | 63.3 | 61.2 | | 75 |
| 80 | | | 67.7 | | 71.4 | 71.4 | | 74.8 | 70.3 | | 69.7 | 67.6 | 63.3 | 61.2 | | 80 |
| 85 | | | 65.8 | | | 68.6 | | 69.9 | 65.7 | | 68.3 | 63.5 | | 61.2 | | 85 |
| 90 | | | | | | 64.4 | | | 61.6 | 57.9 | 64.2 | 59.6 | | 60.8 | 55.9 | 90 |
| 95 | | | | | | | | | | | | 56 | | 58 | 52.6 | 95 |
| 100 | | | | | | | | | | | | 52.9 | | | 49.7 | 100 |
| 105 | | | | | | | | | | | | | | | 46.9 | 105 |
| 110 | | | | | | | | | | | | | | | 44.4 | 110 |

* adapter · pièce d'adaptateur

t_240_004_50201_00_000



| ft | 128 + 11.5 ft* | | | 144 + 11.5 ft* | | | 160 + 11.5 ft* | | | 176 + 11.5 ft* | | | 192 + 11.5 ft* | | | 208 + 11.5 ft* | | 224 + 11.5 ft* | | 240 + 11.5 ft* | | ft |
|-----|----------------|------|------|----------------|------|------|----------------|------|-----|----------------|------|------|----------------|-----|------|----------------|------|----------------|-----|----------------|-----|-----|
| | 69 ft | | | 69 ft | | | 69 ft | | | 69 ft | | | 69 ft | | | 69 ft | | 69 ft | | 69 ft | | |
| | 82° | 75° | 68° | 82° | 75° | 68° | 82° | 75° | 68° | 82° | 75° | 68° | 82° | 75° | 68° | 82° | 75° | 82° | 75° | 82° | 75° | |
| 45 | 54.5 | | | | | | | | | | | | | | | | | | | | | 45 |
| 50 | 54.5 | | | 44.9 | | | 34.6 | | | | | | | | | | | | | | | 50 |
| 55 | 54.5 | | | 44.9 | | | 34.5 | | | 28.3 | | | | | | | | | | | | 55 |
| 60 | 54.5 | | | 44.9 | | | 34.2 | | | 28.2 | | | 21.5 | | | | | | | | | 60 |
| 65 | 54.5 | | | 44.9 | | | 34 | | | 28 | | | 21.4 | | | 15.9 | | | | | | 65 |
| 70 | 54.5 | 52.7 | | 44.9 | | | 33.9 | | | 27.9 | | | 21.3 | | | 15.7 | | 10.3 | | 5.9 | | 70 |
| 75 | 54.5 | 52.8 | | 44.9 | | | 33.8 | | | 27.8 | | | 21.3 | | | 15.6 | | 10.1 | | 5.8 | | 75 |
| 80 | 54.5 | 52.9 | | 44.9 | 43.3 | | 33.8 | | | 27.8 | | | 21.3 | | | 15.4 | | 10 | | 5.7 | | 80 |
| 85 | | 53.1 | | 44.9 | 43 | | 33.8 | 32.9 | | 27.7 | | | 21.3 | | | 15.3 | | 9.9 | | 5.6 | | 85 |
| 90 | | 53.3 | | | 42.9 | | | 32.7 | | 27.7 | 26.8 | | 21.3 | | | 15.3 | | 9.8 | | 5.5 | | 90 |
| 95 | | 53.6 | 50.5 | | 42.7 | | | 32.6 | | | 26.7 | | | | 15.3 | | 9.8 | | 5.5 | | | 95 |
| 100 | | 52.9 | 47.7 | | 42 | | | 32.5 | | | 26.6 | | | | | | | | | | | 100 |
| 105 | | | 45.1 | | 41.2 | 37.5 | | 32.5 | | | 26.5 | | | | 20.2 | | 14.1 | | | | | 105 |
| 110 | | | 42.7 | | | 36.3 | | | | | 26.5 | | | | 20 | | 13.9 | | | | | 110 |
| 115 | | | 40.5 | | | 35.2 | | | | | | 29.4 | | | 19.9 | | 13.8 | | | 8.7 | | 115 |
| 120 | | | | | | 34.2 | | | | | | 28.5 | | | | | 13.8 | | | 8.6 | 4.5 | 120 |
| 125 | | | | | | | | | | | | 27.7 | | | | | | | | 8.5 | 4.4 | 125 |
| 130 | | | | | | | | | | | | | 22.4 | | | | | | | | 4.4 | 130 |
| 135 | | | | | | | | | | | | | 21.7 | | | | | | | | | 135 |
| 140 | | | | | | | | | | | | | 21.1 | | | 16.2 | | | | | | 140 |
| | | | | | | | | | | | | | | | | 15.7 | | | | | | 140 |

* adapter · pièce d'adaptateur

t_240_004_50201_00_000

Lifting capacities Forces de levage

TN



| ft | 48 + 11.5 ft* | | | 64 + 11.5 ft* | | | 80 + 11.5 ft* | | | 96 + 11.5 ft* | | | 112 + 11.5 ft* | | | ft |
|-----|---------------|------|------|---------------|------|------|---------------|------|------|---------------|------|------|----------------|------|------|-----|
| | 80 ft | | | 80 ft | | | 80 ft | | | 80 ft | | | 80 ft | | | |
| | 82° | 75° | 68° | 82° | 75° | 68° | 82° | 75° | 68° | 82° | 75° | 68° | 82° | 75° | 68° | |
| 34 | 85.6 | | | | | | | | | | | | | | | 34 |
| 36 | 85.3 | | | 80.1 | | | | | | | | | | | | 36 |
| 38 | 84.3 | | | 79.9 | | | | | | | | | | | | 38 |
| 40 | 83.4 | | | 79.7 | | | 72.9 | | | | | | | | | 40 |
| 45 | 81.2 | | | 78.9 | | | 72.6 | | | 64.6 | | | 56.3 | | | 45 |
| 50 | 79.3 | 78.7 | | 77.5 | | | 72.4 | | | 64.4 | | | 56.2 | | | 50 |
| 55 | 77.5 | 76.4 | | 76.2 | 75.4 | | 72 | | | 64.4 | | | 56.1 | | | 55 |
| 60 | 76.2 | 73.7 | | 75 | 73.7 | | 71.1 | 70.4 | | 64.4 | | | 56.1 | | | 60 |
| 65 | 74.5 | 71.2 | 70.1 | 74.3 | 71.9 | | 70.5 | 68.9 | | 64.4 | 62.5 | | 56.1 | | | 65 |
| 70 | 70.6 | 68.8 | 67 | 72.6 | 70.6 | | 70.3 | 67.6 | | 64.4 | 62.4 | | 56.1 | 54.4 | | 70 |
| 75 | 62.6 | 67.1 | 64 | 68.3 | 69.5 | 68.5 | 70.3 | 66.7 | | 64.4 | 61.9 | | 56.1 | 54.3 | | 75 |
| 80 | 51.6 | 65.8 | 61.7 | 59.7 | 68.8 | 66.2 | 66.2 | 66 | 65.1 | 64.4 | 61.2 | | 56.1 | 54.3 | | 80 |
| 85 | | 61 | 59.9 | 48.5 | 67.9 | 64.4 | 57.4 | 65.6 | 63.7 | 64.3 | 60.7 | | 56.1 | 54.3 | | 85 |
| 90 | | 49.3 | 59.4 | | 61.5 | 62.8 | | 65 | 61.5 | 54.4 | 60.6 | 58.7 | 56.1 | 54.3 | | 90 |
| 95 | | | 57.7 | | 50.8 | 60.4 | | 61.7 | 57.9 | | 60.1 | 55.7 | | 54.3 | 52.1 | 95 |
| 100 | | | | | | 57 | | | 54.6 | | 56.8 | 52.6 | | 53.9 | 49.3 | 100 |
| 105 | | | | | | | | | 51.6 | | | 49.7 | | 51.5 | 46.6 | 105 |
| 110 | | | | | | | | | 48.9 | | | 47.1 | | | 44.2 | 110 |
| 115 | | | | | | | | | | | | 44.7 | | | 41.9 | 115 |
| 120 | | | | | | | | | | | | | | | 39.9 | 120 |

* adapter · pièce d'adaptateur

t_240_004_50301_00_000



| ft | 128 + 11.5 ft* | | | 144 + 11.5 ft* | | | 160 + 11.5 ft* | | | 176 + 11.5 ft* | | | 192 + 11.5 ft* | | | 208 + 11.5 ft* | | | 224 + 11.5 ft* | | ft |
|-----|----------------|------|------|----------------|------|------|----------------|------|------|----------------|------|------|----------------|------|-----|----------------|------|-----|----------------|-----|-----|
| | 80 ft | | | 80 ft | | | 80 ft | | | 80 ft | | | 80 ft | | | 80 ft | | | 80 ft | | |
| | 82° | 75° | 68° | 82° | 75° | 68° | 82° | 75° | 68° | 82° | 75° | 68° | 82° | 75° | 68° | 82° | 75° | 68° | 82° | 75° | |
| 50 | 48.5 | | | | | | | | | | | | | | | | | | | | 50 |
| 55 | 48.5 | | | 40.4 | | | 30.4 | | | | | | | | | | | | | | 55 |
| 60 | 48.4 | | | 40.4 | | | 30.2 | | | 24.3 | | | | | | | | | | | 60 |
| 65 | 48.4 | | | 40.3 | | | 30.1 | | | 24.3 | | | 19 | | | | | | | | 65 |
| 70 | 48.4 | | | 40.3 | | | 29.9 | | | 24.2 | | | 19 | | | 13.5 | | | | 8.4 | 70 |
| 75 | 48.4 | 46.9 | | 40.3 | | | 29.7 | | | 24.1 | | | 18.9 | | | 13.3 | | | | 8.3 | 75 |
| 80 | 48.4 | 46.9 | | 40.3 | | | 29.6 | | | 24 | | | 18.9 | | | 13.2 | | | | 8.1 | 80 |
| 85 | 48.4 | 47 | | 40.3 | 38.7 | | 29.6 | | | 23.9 | | | 18.9 | | | 13.1 | | | | 8 | 85 |
| 90 | 48.4 | 47 | | 40.3 | 38.5 | | 29.6 | 28.8 | | 23.9 | | | 18.9 | | | 13 | | | | 8 | 90 |
| 95 | 48.4 | 47 | | 40.3 | 38.4 | | 29.6 | 28.7 | | 23.9 | 23.2 | | 18.9 | | | 12.9 | | | | 7.9 | 95 |
| 100 | | 47 | | | 38.4 | | 29.6 | 28.6 | | 23.9 | 23.2 | | 18.9 | | | 12.9 | | | | 7.9 | 100 |
| 105 | | 47 | 45 | | 38.2 | | | 28.6 | | | 23.1 | | | 17.7 | | 12.9 | | | | 7.9 | 105 |
| 110 | | 47 | 42.6 | | 37.8 | 34.5 | | 28.6 | | | 23.1 | | | 17.6 | | | 11.7 | | | | 110 |
| 115 | | | 40.5 | | 37.2 | 33.8 | | 28.6 | | | 23.1 | | | 17.5 | | | 11.7 | | | | 115 |
| 120 | | | 38.5 | | | 32.8 | | 28.6 | 27.1 | | 23.1 | | | 17.4 | | | 11.6 | | | 6.8 | 120 |
| 125 | | | 36.7 | | | 31.9 | | | 26.3 | | 23.1 | | | 17.4 | | | 11.5 | | | 6.7 | 125 |
| 130 | | | | | | 31 | | | 25.6 | | | 20.5 | | | | | 11.5 | | | 6.7 | 130 |
| 135 | | | | | | | | | 25 | | | 19.9 | | | | | | | | 6.6 | 135 |
| 140 | | | | | | | | | 24.4 | | | 19.4 | | | | | | | | | 140 |
| 145 | | | | | | | | | | | | 18.9 | | | | 14.8 | | | | | 145 |
| 150 | | | | | | | | | | | | | | | 14 | | | | | | 150 |
| 155 | | | | | | | | | | | | | | | | | | | 10.3 | | 155 |

* adapter · pièce d'adaptateur

t_240_004_50301_00_000

Lifting capacities Forces de levage

TN



| ft | 48 + 11.5 ft* | | | 64 + 11.5 ft* | | | 80 + 11.5 ft* | | | 96 + 11.5 ft* | | | 112 + 11.5 ft* | | | ft |
|-----|---------------|------|------|---------------|------|------|---------------|------|------|---------------|------|------|----------------|------|------|-----|
| | 92 ft | | | 92 ft | | | 92 ft | | | 92 ft | | | 92 ft | | | |
| | 82° | 75° | 68° | 82° | 75° | 68° | 82° | 75° | 68° | 82° | 75° | 68° | 82° | 75° | 68° | |
| 38 | 74.4 | | | | | | | | | | | | | | | 38 |
| 40 | 73.8 | | | 70.3 | | | | | | | | | | | | 40 |
| 45 | 72 | | | 69.5 | | | 64.4 | | | | | | | | | 45 |
| 50 | 70.3 | | | 68.5 | | | 64 | | | 57.4 | | | 50.1 | | | 50 |
| 55 | 68.8 | 68.4 | | 67.3 | | | 63.4 | | | 57.2 | | | 50 | | | 55 |
| 60 | 67.4 | 66.7 | | 66.3 | 65.8 | | 62.9 | | | 56.9 | | | 49.9 | | | 60 |
| 65 | 66.2 | 64.9 | | 65.2 | 64.3 | | 62.2 | 61.5 | | 56.6 | | | 49.7 | | | 65 |
| 70 | 65.4 | 63.3 | | 64.5 | 63 | | 61.5 | 60.5 | | 56.3 | 54.8 | | 49.6 | | | 70 |
| 75 | 63.9 | 61.5 | 60.6 | 63.9 | 61.8 | | 61.2 | 59.4 | | 56.2 | 54.8 | | 49.6 | 47.7 | | 75 |
| 80 | 61.2 | 60 | 58.2 | 62.7 | 60.8 | 60.4 | 61 | 58.6 | | 56.1 | 54.4 | | 49.6 | 48.1 | | 80 |
| 85 | 54.8 | 58.9 | 56 | 59.3 | 60.1 | 59 | 61 | 57.9 | 57.4 | 56.1 | 53.7 | | 49.6 | 47.9 | | 85 |
| 90 | 46.6 | 57.7 | 54.3 | 52.7 | 59.6 | 57.7 | 57 | 57.4 | 56.4 | 56 | 53.3 | | 49.6 | 47.8 | | 90 |
| 95 | 37.4 | 53.8 | 52.9 | 44.6 | 59.2 | 56.4 | 50.4 | 57.2 | 55.3 | 55.5 | 53 | 52.1 | 49.6 | 47.7 | | 95 |
| 100 | | 45.7 | 52.5 | | 54.3 | 55.4 | 40 | 56.9 | 54 | 48.4 | 52.8 | 51.4 | 49.6 | 47.7 | 45.1 | 100 |
| 105 | | | 51.8 | | 46.9 | 53.7 | | 54.8 | 51.3 | | 52.8 | 49.3 | | 47.7 | 46.1 | 105 |
| 110 | | | | | | 51 | | 47.2 | 48.6 | | 50.6 | 46.7 | | 47.7 | 44 | 110 |
| 115 | | | | | | | | | 46.2 | | 47.8 | 44.4 | | 46.3 | 41.8 | 115 |
| 120 | | | | | | | | | 43.9 | | | 42.2 | | 44 | 39.8 | 120 |
| 125 | | | | | | | | | | | | 40.2 | | | 37.9 | 125 |
| 130 | | | | | | | | | | | | | | | 36.1 | 130 |

* adapter · pièce d'adaptateur

t_240_004_50401_00_000



| ft | 128 + 11.5 ft* | | | 144 + 11.5 ft* | | | 160 + 11.5 ft* | | | 176 + 11.5 ft* | | | 192 + 11.5 ft* | | | 208 + 11.5 ft* | | | 224 + 11.5 ft* | | ft | |
|-----|----------------|------|------|----------------|------|------|----------------|------|------|----------------|------|------|----------------|-----|------|----------------|-----|-----|----------------|-----|-----|-----|
| | 92 ft | | | 92 ft | | | 92 ft | | | 92 ft | | | 92 ft | | | 92 ft | | | 92 ft | | | |
| | 82° | 75° | 68° | 82° | 75° | 68° | 82° | 75° | 68° | 82° | 75° | 68° | 82° | 75° | 68° | 82° | 75° | 68° | 82° | 75° | | |
| 55 | 43.2 | | | 36 | | | | | | | | | | | | | | | | | 55 | |
| 60 | 43.2 | | | 36 | | | 26.2 | | | | | | | | | | | | | | | 60 |
| 65 | 43.2 | | | 36 | | | 26.1 | | 21.5 | | | | | | | | | | | | | 65 |
| 70 | 43.1 | | | 36 | | | 25.9 | | 21.4 | | | 16.8 | | | 11.3 | | | | | | | 70 |
| 75 | 43.1 | | | 36 | | | 25.8 | | 21.3 | | | 16.7 | | | 11.1 | | | | | 6.5 | | 75 |
| 80 | 43.1 | 40.8 | | 36 | | | 25.7 | | 21.2 | | | 16.5 | | | 11 | | | | | 6.4 | | 80 |
| 85 | 43.1 | 41.5 | | 36 | | | 25.5 | | 21.2 | | | 16.4 | | | 10.9 | | | | | 6.3 | | 85 |
| 90 | 43.1 | 41.8 | | 36 | 34.4 | | 25.5 | | 21.1 | | | 16.3 | | | 10.8 | | | | | 6.2 | | 90 |
| 95 | 43.1 | 41.8 | | 36 | 34.5 | | 25.5 | 24.8 | 21.1 | | | 16.2 | | | 10.7 | | | | | 6.1 | | 95 |
| 100 | 43.1 | 41.8 | | 36 | 34.3 | | 25.5 | 24.7 | 21.1 | 20.4 | | 16.2 | | | 10.7 | | | | | 6.1 | | 100 |
| 105 | 43.1 | 41.8 | | 36 | 34.3 | | 25.5 | 24.6 | 21.1 | 20.3 | | 16.2 | | | 10.6 | | | | | 6 | | 105 |
| 110 | | 41.8 | 39.3 | | 34.3 | | 25.5 | 24.6 | 21.1 | 20.3 | | 16.2 | 15 | | 10.6 | | | | | 6 | | 110 |
| 115 | | 41.8 | 39.8 | | 34.3 | | | 24.6 | | 20.3 | | 16.2 | 14.9 | | 10.6 | 9.5 | | | | 6 | | 115 |
| 120 | | 41.8 | 38.1 | | 34 | 31 | | 24.6 | | 20.3 | | 14.8 | | | 9.5 | | | | | 6 | | 120 |
| 125 | | | 36.3 | | 33.6 | 30.4 | | 24.6 | 23.9 | 20.3 | | 14.7 | | | 9.4 | | | | | | 5 | 125 |
| 130 | | | 34.6 | | | 29.6 | | 24.6 | 23.7 | 20.3 | | 14.7 | | | 9.3 | | | | | | 4.9 | 130 |
| 135 | | | | | | 28.8 | | | 23.4 | 20.3 | 18.7 | 14.7 | | | 9.3 | | | | | | 4.9 | 135 |
| 140 | | | 31.6 | | | 28.1 | | | 22.9 | | 18.2 | 14.7 | | | 9.3 | | | | | | 4.9 | 140 |
| 145 | | | | | | 27.4 | | | 22.3 | | 17.8 | | | | 13.4 | | | | | | 4.9 | 145 |
| 150 | | | | | | | | | 21.8 | | 17.3 | | | | 13.1 | | | | | | | 150 |
| 155 | | | | | | | | | | | 16.9 | | | | 12.7 | | | | | | 8.5 | 155 |
| 160 | | | | | | | | | | | | | | | 12.3 | | | | | | 8.4 | 160 |
| 165 | | | | | | | | | | | | | | | | | | | | | 8.4 | 165 |
| 170 | | | | | | | | | | | | | | | | | | | | | 8.3 | 170 |

* adapter · pièce d'adaptateur

t_240_004_50401_00_000

Lifting capacities Forces de levage

TN



| ft | 48 + 11.5 ft* | | | 64 + 11.5 ft* | | | 80 + 11.5 ft* | | | 96 + 11.5 ft* | | | 112 + 11.5 ft* | | | ft | |
|-----|---------------|------|------|---------------|------|------|---------------|------|------|---------------|------|------|----------------|------|------|------|-----|
| | 103 ft | | | 103 ft | | | 103 ft | | | 103 ft | | | 103 ft | | | | |
| | 82° | 75° | 68° | 82° | 75° | 68° | 82° | 75° | 68° | 82° | 75° | 68° | 82° | 75° | 68° | | |
| 45 | 63.5 | | | 60.5 | | | | | | | | | | | | 45 | |
| 50 | 62.3 | | | 59.9 | | | | 55.7 | | | 49.9 | | | | | 50 | |
| 55 | 61.1 | | | 59.2 | | | | 55.3 | | | 49.6 | | | 43.7 | | 55 | |
| 60 | 60 | 59.4 | | 58.5 | | | | 54.8 | | | 49.3 | | | 43.5 | | 60 | |
| 65 | 59 | 58.1 | | 57.7 | 57.1 | | | 54.4 | | | 49.1 | | | 43.4 | | 65 | |
| 70 | 58.1 | 56.9 | | 57 | 56.1 | | | 54 | 53.1 | | 48.8 | | | 43.3 | | 70 | |
| 75 | 57.5 | 55.8 | | 56.5 | 55.1 | | | 53.6 | 52.7 | | 48.6 | 47.2 | | 43.2 | | 75 | |
| 80 | 56.6 | 54.8 | 54.1 | 56.1 | 54.3 | | | 53.4 | 51.9 | | 48.5 | 47.3 | | 43.2 | 41.5 | 80 | |
| 85 | 54.2 | 53.8 | 52.4 | 55.3 | 53.6 | 53 | | 53.2 | 51.3 | | 48.4 | 47.1 | | 43.1 | 41.9 | 85 | |
| 90 | 50.7 | 53.2 | 51 | 53.8 | 52.9 | 52 | | 53.2 | 50.8 | | 48.4 | 46.8 | | 43.1 | 41.8 | 90 | |
| 95 | 45.1 | 52.2 | 49.7 | 49.7 | 52.6 | 51.1 | | 53.2 | 50.3 | 49.5 | 48.4 | 46.5 | | 43.1 | 41.7 | 95 | |
| 100 | 38.3 | 50.2 | 48.7 | 43.7 | 52.3 | 50.3 | | 48 | 50.1 | 48.7 | 48.3 | 46.3 | 44.8 | 43.1 | 41.6 | 100 | |
| 105 | 31 | 45.1 | 48.1 | 37.3 | 51.7 | 49.8 | | 41.9 | 50 | 48.1 | 47.5 | 46.2 | 44.9 | 43.1 | 41.5 | 105 | |
| 110 | | 38.4 | 47.4 | | 46 | 49.5 | | 34.7 | 49.5 | 47.6 | 41.3 | 46.2 | 44.5 | 42.6 | 41.5 | 39.7 | 110 |
| 115 | | | 44.6 | | 39.7 | 48.2 | | | 46.5 | 46 | | 46.2 | 44.1 | 39.1 | 41.5 | 40.2 | 115 |
| 120 | | | 36.8 | | | 45.9 | | | 40.1 | 43.8 | | 45.6 | 42.3 | | 41.5 | 39.5 | 120 |
| 125 | | | | | | 41.1 | | | | 41.7 | | 42.5 | 40.3 | | 41.4 | 37.7 | 125 |
| 130 | | | | | | | | | | 39.8 | | | 38.5 | | 39.9 | 36 | 130 |
| 135 | | | | | | | | | | | | | 36.7 | | | 34.4 | 135 |
| 140 | | | | | | | | | | | | | | | | 32.9 | 140 |
| 145 | | | | | | | | | | | | | | | | 31.4 | 145 |

* adapter · pièce d'adaptateur

t_240_004_50501_00_000



| ft | 128 + 11.5 ft* | | | 144 + 11.5 ft* | | | 160 + 11.5 ft* | | | 176 + 11.5 ft* | | | 192 + 11.5 ft* | | | 208 + 11.5 ft* | | | 224 + 11.5 ft* | | | ft |
|-----|----------------|------|------|----------------|------|------|----------------|------|------|----------------|------|-----|----------------|------|-----|----------------|-----|-----|----------------|-----|-----|-----|
| | 103 ft | | | 103 ft | | | 103 ft | | | 103 ft | | | 103 ft | | | 103 ft | | | 103 ft | | | |
| | 82° | 75° | 68° | 82° | 75° | 68° | 82° | 75° | 68° | 82° | 75° | 68° | 82° | 75° | 68° | 82° | 75° | 68° | 82° | 75° | 68° | |
| 55 | 37.9 | | | | | | | | | | | | | | | | | | | | | 55 |
| 60 | 37.9 | | | 31.7 | | | | | | | | | | | | | | | | | | 60 |
| 65 | 37.8 | | | 31.7 | | | 23.2 | | | | | | | | | | | | | | | 65 |
| 70 | 37.8 | | | 31.6 | | | 23 | | | 19 | | | 14.6 | | | | | | | | | 70 |
| 75 | 37.7 | | | 31.6 | | | 22.9 | | | 18.9 | | | 14.5 | | | 9.4 | | | | | | 75 |
| 80 | 37.7 | | | 31.6 | | | 22.8 | | | 18.8 | | | 14.4 | | | 9.3 | | | | | 5 | 80 |
| 85 | 37.7 | 35.9 | | 31.6 | | | 22.6 | | | 18.7 | | | 14.2 | | | 9.1 | | | | 4.9 | | 85 |
| 90 | 37.7 | 36.2 | | 31.6 | | | 22.5 | | | 18.7 | | | 14.1 | | | 9 | | | | 4.8 | | 90 |
| 95 | 37.7 | 36.5 | | 31.6 | 30.1 | | 22.4 | | | 18.6 | | | 14 | | | 9 | | | | 4.7 | | 95 |
| 100 | 37.7 | 36.5 | | 31.6 | 30.4 | | 22.4 | 21.8 | | 18.6 | | | 13.9 | | | 8.9 | | | | 4.7 | | 100 |
| 105 | 37.7 | 36.5 | | 31.6 | 30.6 | | 22.4 | 21.7 | | 18.5 | 18.1 | | 13.8 | | | 8.8 | | | | 4.6 | | 105 |
| 110 | 37.7 | 36.5 | | 31.6 | 30.6 | | 22.4 | 21.7 | | 18.5 | 17.9 | | 13.8 | | | 8.7 | | | | 4.6 | | 110 |
| 115 | 37.7 | 36.6 | 34.1 | 31.6 | 30.6 | | 22.4 | 21.6 | | 18.5 | 17.8 | | 13.7 | 12.8 | | 8.7 | | | | 4.5 | | 115 |
| 120 | | 36.7 | 34.5 | 31.6 | 30.5 | | 22.4 | 21.6 | | 18.5 | 17.8 | | 13.7 | 12.7 | | 8.7 | 7.8 | | | 4.5 | | 120 |
| 125 | | 36.6 | 35 | | 30.5 | 28.5 | | 21.6 | | 17.8 | | | 13.7 | 12.6 | | 8.7 | 7.8 | | | 4.5 | | 125 |
| 130 | | 36.6 | 34.4 | | 30.5 | 28.1 | | 21.6 | | 17.8 | | | 12.5 | | | 7.7 | | | | 4.5 | 3.6 | 130 |
| 135 | | 36.6 | 32.9 | | 30.4 | 27.4 | | 21.6 | 21 | 17.8 | | | 12.5 | | | 7.6 | | | | 3.6 | | 135 |
| 140 | | | 31.4 | | | 26.7 | | 21.6 | 20.9 | 17.8 | | | 12.4 | | | 7.6 | | | | 3.6 | | 140 |
| 145 | | | 30.1 | | | 26.1 | | | 20.7 | 17.8 | 16.8 | | 12.4 | | | 7.5 | | | | 3.5 | | 145 |
| 150 | | | 28.8 | | | 25.6 | | | 20.6 | | 16.4 | | 12.4 | | | 7.5 | | | | 3.5 | | 150 |
| 155 | | | | | | 25 | | | 20.2 | | 16 | | | 11.6 | | 7.5 | | | | 3.5 | | 155 |
| 160 | | | | | | | | | 19.9 | | 15.6 | | | 11.6 | | | | | | 3.5 | | 160 |
| 165 | | | | | | | | | | | 15.2 | | | 11.3 | | | | | 6.9 | | | 165 |
| 170 | | | | | | | | | | | | | | 11 | | | | | 7 | | | 170 |
| 175 | | | | | | | | | | | | | | 10.7 | | | | | 7.1 | | 3.1 | 175 |
| 180 | | | | | | | | | | | | | | | | | | | 7.1 | | 3.2 | 180 |
| 185 | | | | | | | | | | | | | | | | | | | | | 3.3 | 185 |

* adapter · pièce d'adaptateur

t_240_004_50501_00_000

Lifting capacities Forces de levage

TN

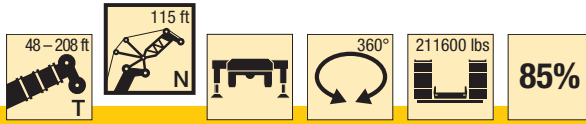

| ft | 48 + 11.5 ft* | | | 64 + 11.5 ft* | | | 80 + 11.5 ft* | | | 96 + 11.5 ft* | | | 112 + 11.5 ft* | | | ft |
|-----|---------------|------|------|---------------|------|------|---------------|------|------|---------------|------|------|----------------|------|------|-----|
| | 115 ft | | | 115 ft | | | 115 ft | | | 115 ft | | | 115 ft | | | |
| | 82° | 75° | 68° | 82° | 75° | 68° | 82° | 75° | 68° | 82° | 75° | 68° | 82° | 75° | 68° | |
| 45 | 56.1 | | | | | | | | | | | | | | | 45 |
| 50 | 55.4 | | | 52.7 | | | 48.9 | | | | | | | | | 50 |
| 55 | 54.6 | | | 52.2 | | | 48.6 | | | 43.8 | | | | | | 55 |
| 60 | 53.7 | | | 51.6 | | | 48.2 | | | 43.6 | | | 38.4 | | | 60 |
| 65 | 52.8 | 52.4 | | 51.1 | | | 47.8 | | | 43.4 | | | 38.4 | | | 65 |
| 70 | 52 | 51.4 | | 50.6 | 50 | | 47.5 | | | 43.1 | | | 38.3 | | | 70 |
| 75 | 51.2 | 50.3 | | 50 | 49.3 | | 47.2 | 46.3 | | 42.9 | | | 38.1 | | | 75 |
| 80 | 50.6 | 49.4 | | 49.4 | 48.5 | | 46.9 | 46.2 | | 42.7 | 41.4 | | 38.1 | | | 80 |
| 85 | 50.2 | 48.6 | 48.2 | 49.1 | 47.8 | | 46.7 | 45.8 | | 42.6 | 41.7 | | 38 | 36.5 | | 85 |
| 90 | 49.3 | 47.8 | 47.2 | 48.8 | 47.1 | | 46.6 | 45.2 | | 42.6 | 41.5 | | 38 | 36.8 | | 90 |
| 95 | 47.2 | 47.2 | 46.1 | 48.5 | 46.5 | 45.9 | 46.5 | 44.8 | | 42.5 | 41.3 | | 38 | 36.9 | | 95 |
| 100 | 44.3 | 46.8 | 44.9 | 48.1 | 46.1 | 45.1 | 46.5 | 44.4 | 43.7 | 42.5 | 41.1 | | 38 | 36.8 | | 100 |
| 105 | 39.6 | 45.9 | 43.9 | 44.7 | 45.9 | 44.5 | 46.2 | 44.1 | 43.2 | 42.5 | 40.9 | 39.1 | 38 | 36.7 | | 105 |
| 110 | 34.3 | 44.1 | 43.2 | 39.7 | 45.9 | 44 | 42.8 | 44 | 42.6 | 42.4 | 40.8 | 39.5 | 38 | 36.6 | | 110 |
| 115 | 28.6 | 40 | 42.8 | 34.4 | 45.5 | 43.6 | 38.4 | 44 | 42.1 | 41.6 | 40.7 | 39.6 | 38 | 36.6 | 34.7 | 115 |
| 120 | | 35 | 42.2 | 27.1 | 41.7 | 43.4 | 32.7 | 43.7 | 41.8 | 37.1 | 40.7 | 39.2 | 37.6 | 36.6 | 35.2 | 120 |
| 125 | | | 39.6 | | 36.7 | 43.3 | | 42 | 41.5 | | 40.7 | 38.9 | 35.5 | 36.6 | 35.5 | 125 |
| 130 | | | 34.4 | | | 41.6 | | 37.3 | 39.7 | | 40.7 | 38.1 | | 36.6 | 35.3 | 130 |
| 135 | | | | | | 38.2 | | | 37.9 | | 38.3 | 36.4 | | 36.6 | 34 | 135 |
| 140 | | | | | | | | | 36.2 | | | 34.8 | | 36.1 | 32.5 | 140 |
| 145 | | | | | | | | | | | | 33.3 | | | 31.1 | 145 |
| 150 | | | | | | | | | | | | 31.9 | | | 29.8 | 150 |
| 155 | | | | | | | | | | | | | | | 28.6 | 155 |

* adapter · pièce d'adaptateur

t_240_004_50601_00_000

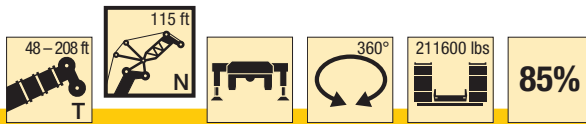

| ft | 128 + 11.5 ft* | | | 144 + 11.5 ft* | | | 160 + 11.5 ft* | | | 176 + 11.5 ft* | | | 192 + 11.5 ft* | | | 208 + 11.5 ft* | | | ft |
|-----|----------------|------|------|----------------|------|------|----------------|------|------|----------------|------|------|----------------|------|-----|----------------|-----|-----|-----|
| | 115 ft | | | 115 ft | | | 115 ft | | | 115 ft | | | 115 ft | | | 115 ft | | | |
| | 82° | 75° | 68° | 82° | 75° | 68° | 82° | 75° | 68° | 82° | 75° | 68° | 82° | 75° | 68° | 82° | 75° | 68° | |
| 60 | 33.5 | | | | | | | | | | | | | | | | | | 60 |
| 65 | 33.4 | | | 28 | | | 20.6 | | | | | | | | | | | | 65 |
| 70 | 33.4 | | | 28 | | | 20.5 | | | 16.8 | | | | | | | | | 70 |
| 75 | 33.3 | | | 28 | | | 20.3 | | | 16.7 | | | 12.3 | | | | | | 75 |
| 80 | 33.3 | | | 28 | | | 20.2 | | | 16.6 | | | 12.2 | | | 7.5 | | | 80 |
| 85 | 33.3 | | | 28 | | | 20.1 | | | 16.5 | | | 12 | | | 7.3 | | | 85 |
| 90 | 33.2 | 31.6 | | 28 | | | 20 | | | 16.5 | | | 11.9 | | | 7.2 | | | 90 |
| 95 | 33.2 | 31.8 | | 28 | | | 19.9 | | | 16.4 | | | 11.8 | | | 7.2 | | | 95 |
| 100 | 33.2 | 32.1 | | 28 | 26.6 | | 19.8 | | | 16.4 | | | 11.7 | | | 7.1 | | | 100 |
| 105 | 33.2 | 32.2 | | 28 | 26.8 | | 19.8 | 19.3 | | 16.3 | | | 11.6 | | | 7 | | | 105 |
| 110 | 33.2 | 32.2 | | 28 | 27 | | 19.8 | 19.2 | | 16.3 | 15.9 | | 11.5 | | | 6.9 | | | 110 |
| 115 | 33.2 | 32.2 | | 28 | 27.1 | | 19.8 | 19.1 | | 16.3 | 15.8 | | 11.5 | | | 6.9 | | | 115 |
| 120 | 33.2 | 32.2 | 29.8 | 28 | 27.2 | | 19.8 | 19.1 | | 16.3 | 15.7 | | 11.4 | 10.6 | | 6.9 | | | 120 |
| 125 | 33.2 | 32.2 | 30.2 | 28 | 27.2 | | 19.8 | 19 | | 16.3 | 15.6 | | 11.4 | 10.5 | | 6.9 | 6 | | 125 |
| 130 | | 32.2 | 30.6 | 28 | 27.2 | 25 | 19.8 | 19 | | 16.3 | 15.5 | | 11.4 | 10.4 | | 6.9 | 6 | | 130 |
| 135 | | 32.2 | 31 | | 27.1 | 25.2 | | 19 | | 16.3 | 15.4 | | 11.4 | 10.3 | | 6.9 | 5.9 | | 135 |
| 140 | | 32.2 | 30.9 | | 27.1 | 25.2 | | 19 | 18.5 | | 15.4 | | 10.3 | | | 6.9 | 5.8 | | 140 |
| 145 | | 32.2 | 29.7 | | 27.1 | 24.7 | | 19 | 18.4 | | 15.4 | | 10.2 | | | 6.9 | 5.8 | | 145 |
| 150 | | | 28.5 | | 27.1 | 24.1 | | 19 | 18.3 | | 15.4 | 14.6 | 10.2 | | | 6.9 | 5.8 | | 150 |
| 155 | | | 27.3 | | | 23.6 | | 19 | 18.2 | | 15.4 | 14.6 | 10.2 | | | 6.9 | 5.8 | | 155 |
| 160 | | | 26.2 | | | 23.2 | | | 18.2 | | | 14.5 | 10.2 | 9.6 | | 6.9 | 5.8 | | 160 |
| 165 | | | | | | 22.7 | | | 18.1 | | | 14.2 | | 9.7 | | 6.9 | 5.8 | | 165 |
| 170 | | | | | | | | | 17.9 | | | 13.9 | | 9.8 | | | | 5.3 | 170 |
| 175 | | | | | | | | | 17.6 | | | 13.6 | | 9.7 | | | | 5.4 | 175 |
| 180 | | | | | | | | | | | | 13.3 | | 9.6 | | | | 5.6 | 180 |
| 185 | | | | | | | | | | | | | | 9.3 | | | | 5.7 | 185 |
| 190 | | | | | | | | | | | | | | | | | | 5.8 | 190 |

* adapter · pièce d'adaptateur

t_240_004_50601_00_000

Lifting capacities Forces de levage

TN



| ft | 48 + 11.5 ft* | | | 64 + 11.5 ft* | | | 80 + 11.5 ft* | | | 96 + 11.5 ft* | | | 112 + 11.5 ft* | | | ft | |
|-----|---------------|------|------|---------------|------|------|---------------|------|------|---------------|------|------|----------------|------|------|------|-----|
| | 126 ft | | | 126 ft | | | 126 ft | | | 126 ft | | | 126 ft | | | | |
| | 82° | 75° | 68° | 82° | 75° | 68° | 82° | 75° | 68° | 82° | 75° | 68° | 82° | 75° | 68° | | |
| 50 | 49.1 | | | | | | | | | | | | | | | 50 | |
| 55 | 48.5 | | | 46.3 | | | 43.1 | | | | | | | | | 55 | |
| 60 | 47.9 | | | 45.8 | | | 42.7 | | | | 38.6 | | | 34 | | 60 | |
| 65 | 47.3 | | | 45.4 | | | 42.4 | | | | 38.4 | | | 34 | | 65 | |
| 70 | 46.5 | | | 45 | | | 42.1 | | | | 38.2 | | | 33.9 | | 70 | |
| 75 | 45.8 | 45.4 | | 44.5 | 43.9 | | 41.8 | | | | 38 | | | 33.8 | | 75 | |
| 80 | 45.2 | 44.6 | | 44.1 | 43.7 | | 41.6 | 40.6 | | | 37.9 | | | 33.7 | | 80 | |
| 85 | 44.6 | 43.8 | | 43.7 | 43.1 | | 41.4 | 40.7 | | | 37.7 | 36.5 | | 33.6 | | 85 | |
| 90 | 44.2 | 43 | | 43.4 | 42.5 | | 41.2 | 40.4 | | | 37.6 | 36.6 | | 33.5 | 32.2 | 90 | |
| 95 | 43.8 | 42.4 | 42 | 43.1 | 41.9 | | 41.1 | 40.1 | | | 37.5 | 36.6 | | 33.5 | 32.4 | 95 | |
| 100 | 43.1 | 41.8 | 41.2 | 42.8 | 41.4 | 41 | 41 | 39.8 | | | 37.5 | 36.5 | | 33.5 | 32.5 | 100 | |
| 105 | 42.1 | 41.4 | 40.4 | 41.9 | 40.9 | 40.4 | 40.7 | 39.4 | 38.4 | | 37.5 | 36.3 | | 33.5 | 32.5 | 105 | |
| 110 | 40 | 41.1 | 39.7 | 40.8 | 40.7 | 39.7 | 40.1 | 39.1 | 38.5 | | 37.5 | 36.2 | | 33.5 | 32.4 | 110 | |
| 115 | 36 | 40.7 | 39 | 38.4 | 40.5 | 39.2 | 39.2 | 39 | 38 | | 37.5 | 36.1 | 34.6 | 33.5 | 32.4 | 115 | |
| 120 | 31.6 | 39.6 | 38.5 | 35.3 | 40 | 38.8 | 37.4 | 38.8 | 37.6 | | 37.3 | 36.1 | 34.9 | 33.5 | 32.4 | 30.5 | 120 |
| 125 | 26.9 | 36.4 | 38.2 | 31.1 | 39.1 | 38.5 | 34.4 | 38.6 | 37.2 | | 36.6 | 36 | 34.9 | 33.5 | 32.4 | 30.8 | 125 |
| 130 | | 32.4 | 37.8 | 26.2 | 36.9 | 38.4 | 29.9 | 38.2 | 37 | | 33.3 | 36 | 34.7 | 33.3 | 32.4 | 31.1 | 130 |
| 135 | | 27 | 36.1 | | 33.2 | 38.4 | | 37 | 36.8 | | 28.7 | 36 | 34.5 | 31.7 | 32.4 | 31.4 | 135 |
| 140 | | | 32.2 | | 28 | 37.5 | | 33.8 | 36 | | | 35.9 | 34.2 | | 32.4 | 31.4 | 140 |
| 145 | | | | | | 34.6 | | | 34.4 | | | 34 | 33 | | 32.4 | 30.7 | 145 |
| 150 | | | | | | 28.9 | | | 33 | | | 29.3 | 31.7 | | 32.4 | 29.5 | 150 |
| 155 | | | | | | | | | 31 | | | | 30.4 | | | 28.3 | 155 |
| 160 | | | | | | | | | | | | | 29.2 | | | 27.1 | 160 |
| 165 | | | | | | | | | | | | | | | | 26.1 | 165 |

* adapter - pièce d'adaptateur

t_240_004_50701_00_000

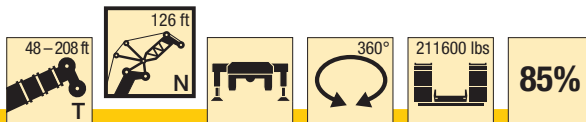

| ft | 128 + 11.5 ft* | | | 144 + 11.5 ft* | | | 160 + 11.5 ft* | | | 176 + 11.5 ft* | | | 192 + 11.5 ft* | | | 208 + 11.5 ft* | | | ft |
|-----|----------------|------|------|----------------|------|------|----------------|------|------|----------------|------|------|----------------|-----|-----|----------------|-----|-----|-----|
| | 126 ft | | | 126 ft | | | 126 ft | | | 126 ft | | | 126 ft | | | 126 ft | | | |
| | 82° | 75° | 68° | 82° | 75° | 68° | 82° | 75° | 68° | 82° | 75° | 68° | 82° | 75° | 68° | 82° | 75° | 68° | |
| 65 | 29.6 | | | | | | | | | | | | | | | | | | 65 |
| 70 | 29.6 | | | 24.7 | | | 18.2 | | | | | | | | | | | | 70 |
| 75 | 29.6 | | | 24.7 | | | 18.1 | | | 14.8 | | | | | | | | | 75 |
| 80 | 29.5 | | | 24.7 | | | 18 | | | 14.7 | | | | | | | | | 80 |
| 85 | 29.4 | | | 24.6 | | | 17.9 | | | 14.6 | | | 10.3 | | | | | | 85 |
| 90 | 29.4 | | | 24.6 | | | 17.8 | | | 14.6 | | | 10 | | | | | | 90 |
| 95 | 29.4 | | | 24.6 | | | 17.7 | | | 14.5 | | | 9.9 | | | | | | 95 |
| 100 | 29.3 | 28.1 | | 24.6 | | | 17.7 | | | 14.4 | | | 9.8 | | | | | | 100 |
| 105 | 29.3 | 28.3 | | 24.6 | 23.4 | | 17.6 | | | 14.4 | | | 9.7 | | | | | | 105 |
| 110 | 29.3 | 28.4 | | 24.6 | 23.5 | | 17.5 | 17.1 | | 14.3 | | | 9.6 | | | | | | 110 |
| 115 | 29.3 | 28.5 | | 24.6 | 23.7 | | 17.5 | 16.9 | | 14.3 | 13.5 | | 9.5 | | | | | | 115 |
| 120 | 29.3 | 28.5 | | 24.6 | 23.9 | | 17.5 | 16.8 | | 14.2 | 13.4 | | 9.5 | | | | | | 120 |
| 125 | 29.3 | 28.5 | | 24.6 | 23.9 | | 17.5 | 16.8 | | 14.2 | 13.3 | | 9.5 | 8.6 | | | | | 125 |
| 130 | 29.3 | 28.5 | 26.5 | 24.6 | 24 | | 17.5 | 16.8 | | 14.2 | 13.2 | | 9.4 | 8.6 | | | | | 130 |
| 135 | 29.3 | 28.4 | 26.8 | 24.6 | 24 | | 17.5 | 16.8 | | 14.2 | 13.1 | | 9.4 | 8.5 | | | | | 135 |
| 140 | 29 | 28.4 | 27.2 | 24.6 | 24.1 | 22.1 | 17.5 | 16.8 | | 14.2 | 13.1 | | 9.4 | 8.4 | | | | | 140 |
| 145 | | 28.4 | 27.5 | | 24.1 | 22.4 | 17.5 | 16.8 | 16.4 | 14.2 | 13.1 | | 9.4 | 8.4 | | | | | 145 |
| 150 | | 28.4 | 27.7 | | 24.1 | 22.4 | | 16.8 | 16.3 | | 13.1 | | | 8.4 | | | | | 150 |
| 155 | | 28.4 | 26.9 | | 24.1 | 22.2 | | 16.8 | 16.2 | | 13.1 | 12.3 | | 8.4 | | | | | 155 |
| 160 | | | 25.9 | | 24.1 | 21.8 | | 16.8 | 16.1 | | 13.1 | 12.5 | | 8.4 | | | | | 160 |
| 165 | | | 24.8 | | | 21.4 | | 16.8 | 16.1 | | 13.1 | 12.6 | | 8.4 | 7.9 | | | | 165 |
| 170 | | | 23.9 | | | 21 | | | 16 | | 13.1 | 12.6 | | 8.4 | 8 | | | | 170 |
| 175 | | | | | | 20.7 | | | 16 | | | 12.5 | | 8.4 | 8.1 | | | | 175 |
| 180 | | | | | | 20.1 | | | 16 | | | 12.4 | | | 8.2 | | | | 180 |
| 185 | | | | | | | | | 15.9 | | | 12.1 | | | 8.3 | | | | 185 |
| 190 | | | | | | | | | | | | 11.9 | | | 8.3 | | | | 190 |
| 195 | | | | | | | | | | | | | | | 8.1 | | | | 195 |
| 200 | | | | | | | | | | | | | | | | | | | 200 |

* adapter - pièce d'adaptateur

t_240_004_50701_00_000

Lifting capacities Forces de levage

TN

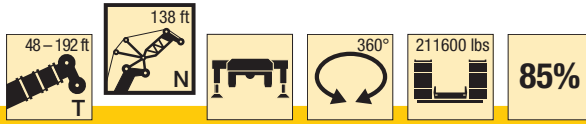

| ft | 48 + 11.5 ft* | | | 64 + 11.5 ft* | | | 80 + 11.5 ft* | | | 96 + 11.5 ft* | | | 112 + 11.5 ft* | | | ft |
|-----|---------------|------|------|---------------|------|------|---------------|------|------|---------------|------|------|----------------|------|------|-----|
| | 138 ft | | | 138 ft | | | 138 ft | | | 138 ft | | | 138 ft | | | |
| | 82° | 75° | 68° | 82° | 75° | 68° | 82° | 75° | 68° | 82° | 75° | 68° | 82° | 75° | 68° | |
| 55 | 43.2 | | | 41 | | | | | | | | | | | | 55 |
| 60 | 42.7 | | | 40.7 | | | 37.9 | | | | | | | | | 60 |
| 65 | 42.1 | | | 40.3 | | | 37.7 | | | | | | | | | 65 |
| 70 | 41.6 | | | 40 | | | 37.4 | | | | | | | | | 70 |
| 75 | 41 | | | 39.6 | | | 37.1 | | | | | | | | | 75 |
| 80 | 40.5 | 40.3 | | 39.2 | 38.6 | | 36.9 | | | | | | | | | 80 |
| 85 | 40 | 39.6 | | 38.9 | 38.5 | | 36.7 | 35.7 | | | | | | | | 85 |
| 90 | 39.5 | 38.9 | | 38.6 | 38.2 | | 36.5 | 35.8 | | | | | | | | 90 |
| 95 | 38.9 | 38.2 | | 38.3 | 37.7 | | 36.3 | 35.7 | | | | | | | | 95 |
| 100 | 38 | 37.7 | 37.6 | 37.6 | 37.2 | | 36 | 35.4 | | | | | | | | 100 |
| 105 | 37.2 | 37.2 | 36.8 | 36.9 | 36.8 | 36.4 | 35.7 | 35.2 | | | | | | | | 105 |
| 110 | 35.9 | 36.7 | 36.2 | 35.9 | 36.5 | 36 | 35.4 | 35 | 33.6 | | | | | | | 110 |
| 115 | 34.7 | 35.9 | 35.6 | 34.7 | 36 | 35.5 | 34.5 | 34.7 | 33.8 | 32.8 | 32 | | | | | 115 |
| 120 | 33.2 | 35 | 35.1 | 33.6 | 35.1 | 34.9 | 33.4 | 34.4 | 33.8 | 32.3 | 31.8 | 30.2 | | | | 120 |
| 125 | 31.3 | 33.8 | 34.6 | 32.5 | 34.3 | 34.6 | 32.4 | 33.9 | 33.5 | 31.8 | 31.8 | 30.5 | 29.5 | 28.6 | 26.7 | 125 |
| 130 | 28.5 | 32.7 | 33.9 | 31.1 | 33.2 | 34.2 | 31.5 | 33.3 | 33.2 | 31.1 | 31.8 | 30.8 | 29.5 | 28.6 | 26.9 | 130 |
| 135 | 24.7 | 31.6 | 32.9 | 28 | 32.1 | 33.5 | 29.8 | 32.3 | 32.9 | 30.2 | 31.7 | 30.8 | 29.4 | 28.6 | 27.2 | 135 |
| 140 | 20.1 | 29.2 | 31.9 | 24.2 | 31.2 | 32.7 | 27.1 | 31.4 | 32.6 | 28.8 | 31.1 | 30.7 | 28.8 | 28.6 | 27.5 | 140 |
| 145 | | 25.2 | 30.9 | | 29.3 | 31.7 | | 30.5 | 32.1 | 26.5 | 30.5 | 30.5 | 28 | 28.6 | 27.7 | 145 |
| 150 | | | 29 | | 26 | 30.8 | | 29.4 | 31.3 | | 29.7 | 30.4 | 28.6 | 27.7 | 150 | |
| 155 | | | | | | 29.9 | | 26.4 | 30.4 | | 29.1 | 30 | 28.5 | 27.6 | 155 | |
| 160 | | | | | | 27.4 | | | 29.7 | | 27 | 28.8 | 28.1 | 26.7 | 160 | |
| 165 | | | | | | | | | 28.6 | | | 27.7 | 26.9 | 25.7 | 165 | |
| 170 | | | | | | | | | | | | 26.6 | | 24.7 | 170 | |
| 175 | | | | | | | | | | | | | | 23.8 | 175 | |
| 180 | | | | | | | | | | | | | | 22.8 | 180 | |

* adapter · pièce d'adaptateur

t_240_004_50801_00_000



| ft | 128 + 11.5 ft* | | | 144 + 11.5 ft* | | | 160 + 11.5 ft* | | | 176 + 11.5 ft* | | | 192 + 11.5 ft* | | | ft |
|-----|----------------|------|------|----------------|------|------|----------------|------|------|----------------|------|------|----------------|-----|-----|-----|
| | 138 ft | | | 138 ft | | | 138 ft | | | 138 ft | | | 138 ft | | | |
| | 82° | 75° | 68° | 82° | 75° | 68° | 82° | 75° | 68° | 82° | 75° | 68° | 82° | 75° | 68° | |
| 70 | 26.1 | | | 21.9 | | | | | | | | | | | | 70 |
| 75 | 26 | | | 21.9 | | | 15.9 | | | | | | | | | 75 |
| 80 | 25.9 | | | 21.8 | | | 15.9 | | | | | | | | | 80 |
| 85 | 25.9 | | | 21.8 | | | 15.8 | | | | | | | | | 85 |
| 90 | 25.8 | | | 21.8 | | | 15.7 | | | | | | | | | 90 |
| 95 | 25.8 | | | 21.8 | | | 15.7 | | | | | | | | | 95 |
| 100 | 25.8 | | | 21.8 | | | 15.6 | | | | | | | | | 100 |
| 105 | 25.7 | 24.7 | | 21.8 | | | 15.6 | | | | | | | | | 105 |
| 110 | 25.7 | 24.8 | | 21.8 | 20.7 | | 15.5 | | | | | | | | | 110 |
| 115 | 25.7 | 24.9 | | 21.8 | 20.8 | | 15.4 | 15 | | | | | | | | 115 |
| 120 | 25.7 | 25 | | 21.8 | 21 | | 15.4 | 14.9 | | | | | | | | 120 |
| 125 | 25.7 | 25 | | 21.8 | 21.1 | | 15.4 | 14.8 | | | | | | | | 125 |
| 130 | 25.7 | 25 | | 21.8 | 21.2 | | 15.4 | 14.7 | | | | | | | | 130 |
| 135 | 25.7 | 25 | 23.1 | 21.8 | 21.2 | | 15.4 | 14.7 | | | | | | | | 135 |
| 140 | 25.7 | 24.9 | 23.3 | 21.8 | 21.3 | | 15.4 | 14.6 | | | | | | | | 140 |
| 145 | 25.3 | 24.9 | 23.6 | 21.8 | 21.2 | 19.4 | 15.4 | 14.6 | | | | | | | | 145 |
| 150 | 24.9 | 24.9 | 23.9 | 21.8 | 21.2 | 19.6 | 15.4 | 14.6 | 14.2 | | | | | | | 150 |
| 155 | | 24.9 | 24.2 | | 21.2 | 19.9 | 15.4 | 14.6 | 14.2 | 11.9 | 10.9 | | | | | 155 |
| 160 | | 24.9 | 24.3 | | 21.2 | 20.1 | | 14.6 | 14.1 | | 10.9 | 10.9 | | | | 160 |
| 165 | | 24.9 | 24.3 | | 21.2 | 20 | | 14.6 | 14.1 | | 10.9 | 10.5 | | | | 165 |
| 170 | | | 23.8 | | 21.2 | 19.7 | | 14.6 | 14.1 | | 10.9 | 10.7 | | | | 170 |
| 175 | | | 22.9 | | | 19.4 | | 14.6 | 14.1 | | 10.9 | 10.8 | | | | 175 |
| 180 | | | 22 | | | 19.1 | | | 14 | | 10.9 | 10.9 | | | | 180 |
| 185 | | | 21.2 | | | 18.8 | | | 14 | | 10.9 | 10.9 | | | | 185 |
| 190 | | | | | | 18.3 | | | 14 | | | 10.8 | | | | 190 |
| 195 | | | | | | | | | 14 | | | 10.7 | | | | 195 |
| 200 | | | | | | | | | | | | 10.5 | | | | 200 |
| 205 | | | | | | | | | | | | | | | | 205 |

* adapter · pièce d'adaptateur

t_240_004_50801_00_000

Lifting capacities Forces de levage

TN

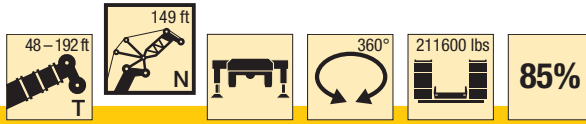

| ft | 48 + 11.5 ft* | | | 64 + 11.5 ft* | | | 80 + 11.5 ft* | | | 96 + 11.5 ft* | | | 112 + 11.5 ft* | | | ft |
|-----|---------------|------|------|---------------|------|------|---------------|------|------|---------------|------|------|----------------|------|------|-----|
| | 149 ft | | | 149 ft | | | 149 ft | | | 149 ft | | | 149 ft | | | |
| | 82° | 75° | 68° | 82° | 75° | 68° | 82° | 75° | 68° | 82° | 75° | 68° | 82° | 75° | 68° | |
| 60 | 37.8 | | | 35.9 | | | 33.3 | | | 30.1 | | | | | | 60 |
| 65 | 37.4 | | | 35.7 | | | 33.1 | | | 30 | | | | | | 65 |
| 70 | 36.9 | | | 35.4 | | | 32.8 | | | 29.8 | | | | 26.5 | | 70 |
| 75 | 36.5 | | | 35.1 | | | 32.6 | | | 29.7 | | | | 26.3 | | 75 |
| 80 | 36.1 | | | 34.8 | | | 32.4 | | | 29.5 | | | | 26.2 | | 80 |
| 85 | 35.8 | 35.5 | | 34.5 | 33.7 | | 32.2 | 31.3 | | 29.4 | | | | 26.1 | | 85 |
| 90 | 35.4 | 35.1 | | 34.3 | 33.7 | | 32.1 | 31.4 | | 29.3 | 28.2 | | | 26 | | 90 |
| 95 | 35 | 34.5 | | 34 | 33.6 | | 31.9 | 31.4 | | 29.2 | 28.3 | | | 25.9 | 25.2 | 95 |
| 100 | 34.6 | 34 | | 33.8 | 33.3 | | 31.8 | 31.2 | | 29.1 | 28.4 | | | 25.9 | 25.1 | 100 |
| 105 | 34.3 | 33.5 | 33.4 | 33.6 | 33 | | 31.7 | 31.1 | | 29 | 28.4 | | | 25.9 | 25.2 | 105 |
| 110 | 34.1 | 33.1 | 32.9 | 33.5 | 32.7 | 31.7 | 31.7 | 31.1 | | 29 | 28.4 | | | 25.9 | 25.3 | 110 |
| 115 | 33.8 | 32.6 | 32.2 | 33.3 | 32.4 | 31.9 | 31.6 | 30.9 | | 29 | 28.3 | | | 25.9 | 25.2 | 115 |
| 120 | 33.6 | 32.3 | 31.7 | 33.2 | 32.1 | 31.6 | 31.6 | 30.7 | 29.5 | 29 | 28.2 | | | 25.9 | 25.1 | 120 |
| 125 | 33.3 | 32.1 | 31.3 | 33 | 31.9 | 31.2 | 31.5 | 30.6 | 29.7 | 29 | 28.1 | 26.4 | | 25.9 | 25.1 | 125 |
| 130 | 31.4 | 32 | 30.9 | 32.4 | 31.7 | 30.9 | 31.5 | 30.5 | 29.8 | 29 | 28 | 26.7 | | 25.9 | 25.1 | 130 |
| 135 | 28.6 | 32 | 30.7 | 30.5 | 31.7 | 30.6 | 30.8 | 30.4 | 29.6 | 29 | 28 | 26.9 | | 25.9 | 25.1 | 135 |
| 140 | 25.7 | 31.3 | 30.5 | 28.3 | 31.7 | 30.4 | 29.7 | 30.3 | 29.4 | 29 | 28 | 27.1 | | 25.9 | 25.1 | 140 |
| 145 | 22.6 | 29.2 | 30.4 | 25.5 | 31.2 | 30.2 | 27.8 | 30.3 | 29.2 | 28.9 | 28 | 27.2 | | 25.9 | 25.1 | 145 |
| 150 | 19.2 | 26.5 | 30.2 | 22.3 | 29.6 | 30.1 | 24.8 | 30.2 | 29 | 27 | 28 | 27.1 | | 25.9 | 25.1 | 150 |
| 155 | | 23.4 | 29.1 | | 27.3 | 30.1 | 21.4 | 29.7 | 29 | 24.2 | 28 | 27.1 | | 25.6 | 25.1 | 155 |
| 160 | | 18.7 | 26.8 | | 24 | 29.8 | | 27.8 | 29 | | 28 | 27 | | 24.1 | 25.1 | 160 |
| 165 | | | 23.1 | | | 28.5 | | 24.6 | 28.7 | | 27.6 | 27 | | | 25.1 | 165 |
| 170 | | | | | | 25.3 | | | 27.6 | | 25.1 | 26.4 | | | 25.1 | 170 |
| 175 | | | | | | | | | 26.4 | | | 25.4 | | | 24.9 | 175 |
| 180 | | | | | | | | | | | | 24.4 | | | | 180 |
| 185 | | | | | | | | | | | | 23.5 | | | | 185 |
| 190 | | | | | | | | | | | | | | | 21.2 | 190 |

* adapter - pièce d'adaptateur

t_240_004_50901_00_000



| ft | 128 + 11.5 ft* | | | 144 + 11.5 ft* | | | 160 + 11.5 ft* | | | 176 + 11.5 ft* | | | 192 + 11.5 ft* | | | ft |
|-----|----------------|------|------|----------------|------|------|----------------|------|------|----------------|-----|-----|----------------|-----|-----|-----|
| | 149 ft | | | 149 ft | | | 149 ft | | | 149 ft | | | 149 ft | | | |
| | 82° | 75° | 68° | 82° | 75° | 68° | 82° | 75° | 68° | 82° | 75° | 68° | 82° | 75° | 68° | |
| 70 | 23.1 | | | | | | | | | | | | | | | 70 |
| 75 | 23.1 | | | | | | | | | | | | | | | 75 |
| 80 | 23 | | | 19.4 | | | | | | | | | | | | 80 |
| 85 | 23 | | | 19.4 | | | | | | 10.9 | | | 6.8 | | | 85 |
| 90 | 22.9 | | | 19.3 | | | | | | 10.8 | | | 6.7 | | | 90 |
| 95 | 22.9 | | | 19.3 | | | | | | 10.7 | | | 6.6 | | | 95 |
| 100 | 22.8 | | | 19.3 | | | | | | 10.6 | | | 6.5 | | | 100 |
| 105 | 22.8 | | | 19.3 | | | | | | 10.4 | | | 6.4 | | | 105 |
| 110 | 22.8 | 21.8 | | 19.3 | | | | | | 10.3 | | | 6.3 | | | 110 |
| 115 | 22.8 | 21.9 | | 19.3 | 18.3 | | | | | 10.3 | | | 6.3 | | | 115 |
| 120 | 22.8 | 22.1 | | 19.3 | 18.4 | | | 13.6 | 13.3 | 10.2 | | | 6.2 | | | 120 |
| 125 | 22.8 | 22.1 | | 19.3 | 18.5 | | | 13.6 | 13.2 | 10.1 | 9.5 | | 6.1 | | | 125 |
| 130 | 22.8 | 22.1 | | 19.3 | 18.6 | | | 13.6 | 13.1 | 10.1 | 9.4 | | 6.1 | | | 130 |
| 135 | 22.8 | 22.2 | | 19.3 | 18.7 | | | 13.5 | 13 | 10 | 9.3 | | 6.1 | 5.4 | | 135 |
| 140 | 22.8 | 22.2 | 20.3 | 19.3 | 18.8 | | | 13.5 | 12.9 | 10 | 9.2 | | 6 | 5.3 | | 140 |
| 145 | 22.8 | 22.2 | 20.5 | 19.3 | 18.8 | | | 13.5 | 12.8 | 10 | 9.2 | | 6 | 5.2 | | 145 |
| 150 | 22.8 | 22.2 | 20.7 | 19.3 | 18.8 | 17 | | 13.5 | 12.8 | 10 | 9.2 | | 6 | 5.2 | | 150 |
| 155 | 22.8 | 22.3 | 21 | 19.3 | 18.8 | 17.2 | | 13.5 | 12.8 | 10 | 9.2 | | 6 | 5.2 | | 155 |
| 160 | 22.8 | 22.3 | 21.2 | 19.3 | 18.7 | 17.4 | | 13.5 | 12.8 | 12.5 | 9.2 | | 6 | 5.2 | | 160 |
| 165 | | 22.3 | 21.4 | 19.3 | 18.7 | 17.7 | | 13.5 | 12.8 | 12.5 | 10 | 9.2 | 6 | 5.2 | | 165 |
| 170 | | 22.3 | 21.6 | | 18.7 | 17.8 | | | 12.8 | 12.4 | 10 | 9.2 | 8.9 | 6 | 5.2 | 170 |
| 175 | | 22.3 | 21.7 | | 18.7 | 17.9 | | | 12.8 | 12.4 | | 9.2 | 9 | | 5.2 | 175 |
| 180 | | 22.3 | 21.7 | | 18.7 | 17.8 | | | 12.8 | 12.4 | | 9.2 | 9.2 | | 5.2 | 180 |
| 185 | | | 21 | | 18.7 | 17.6 | | | 12.8 | 12.3 | | 9.2 | 9.3 | | 5.2 | 185 |
| 190 | | | 20.2 | | | 17.3 | | | | 12.3 | | 9.2 | 9.3 | | 5.2 | 190 |
| 195 | | | 19.4 | | | 17.1 | | | | 12.3 | | | 9.2 | | 5.3 | 195 |
| 200 | | | | | | 16.7 | | | | 12.3 | | | 9.2 | | 5.4 | 200 |
| 205 | | | | | | | | | | 12.3 | | | 9.2 | | 5.3 | 205 |
| 210 | | | | | | | | | | | | | 9.2 | | 5.3 | 210 |
| 215 | | | | | | | | | | | | | 9.1 | | 5.3 | 215 |
| 220 | | | | | | | | | | | | | | | 5.3 | 220 |

* adapter - pièce d'adaptateur

t_240_004_50901_00_000

Lifting capacities Forces de levage

TN



| ft | 48 + 11.5 ft* | | | 64 + 11.5 ft* | | | 80 + 11.5 ft* | | | 96 + 11.5 ft* | | | 112 + 11.5 ft* | | | 128 + 11.5 ft* | | | 144 + 11.5 ft* | | | 160 + 11.5 ft* | | | 176 + 11.5 ft* | | | ft |
|-----|---------------|------|------|---------------|------|------|---------------|------|------|---------------|------|------|----------------|------|------|----------------|------|------|----------------|------|------|----------------|------|------|----------------|-----|-----|-----|
| | 161 ft | | | 161 ft | | | 161 ft | | | 161 ft | | | 161 ft | | | 161 ft | | | 161 ft | | | 161 ft | | | | | | |
| | 82° | 75° | 68° | 82° | 75° | 68° | 82° | 75° | 68° | 82° | 75° | 68° | 82° | 75° | 68° | 82° | 75° | 68° | 82° | 75° | 68° | 82° | 75° | 68° | 82° | 75° | 68° | |
| 65 | 33.3 | | | 31.7 | | | | | | | | | | | | | | | | | | | | | | | 65 | |
| 70 | 33 | | | 31.5 | | | 29.4 | | | 26.5 | | | | | | | | | | | | | | | | | 70 | |
| 75 | 32.6 | | | 31.2 | | | 29.2 | | | 26.3 | | | 23.4 | | | 20.5 | | | | | | | | | | | 75 | |
| 80 | 32.3 | | | 31 | | | 29 | | | 26.2 | | | 23.3 | | | 20.4 | | | 17.1 | | | | | | | | 80 | |
| 85 | 32 | | | 30.7 | | | 28.8 | | | 26.1 | | | 23.3 | | | 20.4 | | | 17.1 | | | 12.3 | | | 9.1 | | 85 | |
| 90 | 31.6 | 31.3 | | 30.5 | 29.7 | | 28.6 | | | 26 | | | 23.2 | | | 20.3 | | | 17.1 | | | 12.3 | | | 8.9 | | 90 | |
| 95 | 31.3 | 31.2 | | 30.3 | 29.7 | | 28.5 | 27.6 | | 25.8 | | | 23.1 | | | 20.3 | | | 17 | | | 12.2 | | | 8.8 | | 95 | |
| 100 | 30.9 | 30.7 | | 30 | 29.7 | | 28.3 | 27.6 | | 25.7 | 24.8 | | 23 | | | 20.2 | | | 17 | | | 12.1 | | | 8.7 | | 100 | |
| 105 | 30.6 | 30.3 | | 29.8 | 29.5 | | 28.2 | 27.6 | | 25.7 | 24.9 | | 23 | 22.1 | | 20.2 | | | 17 | | | 12.1 | | | 8.6 | | 105 | |
| 110 | 30.3 | 29.8 | 29.4 | 29.7 | 29.3 | | 28.1 | 27.6 | | 25.6 | 25 | | 23 | 22.2 | | 20.2 | | | 17 | | | 12.1 | | | 8.5 | | 110 | |
| 115 | 30.1 | 29.5 | 29.3 | 29.5 | 29.1 | | 27.9 | 27.5 | | 25.5 | 25 | | 22.9 | 22.3 | | 20.2 | 19.3 | | 17 | | | 12 | | | 8.4 | | 115 | |
| 120 | 29.9 | 29.1 | 28.9 | 29.4 | 28.8 | 27.9 | 27.9 | 27.3 | | 25.4 | 24.9 | | 22.9 | 22.3 | | 20.2 | 19.4 | | 17 | 16.2 | | 12 | | | 8.3 | | 120 | |
| 125 | 29.8 | 28.8 | 28.4 | 29.2 | 28.5 | 28 | 27.8 | 27.2 | 25.8 | 25.4 | 24.8 | | 22.9 | 22.3 | | 20.2 | 19.5 | | 17 | 16.3 | | 11.9 | 11.4 | | 8.2 | | 125 | |
| 130 | 29.7 | 28.6 | 28 | 29 | 28.3 | 27.9 | 27.7 | 27 | 26 | 25.3 | 24.7 | 23.1 | 22.9 | 22.3 | | 20.2 | 19.6 | | 17 | 16.3 | | 11.9 | 11.3 | | 8.2 | 7.6 | 130 | |
| 135 | 29.5 | 28.4 | 27.6 | 28.7 | 28.1 | 27.6 | 27.4 | 26.9 | 26.1 | 25.1 | 24.7 | 23.3 | 22.9 | 22.2 | | 20.2 | 19.6 | | 17 | 16.4 | | 11.8 | 11.2 | | 8.1 | 7.5 | 135 | |
| 140 | 27.8 | 28.3 | 27.3 | 28.1 | 28 | 27.3 | 27.2 | 26.9 | 26.1 | 25 | 24.6 | 23.5 | 22.9 | 22.2 | 20.7 | 20.2 | 19.6 | | 17 | 16.5 | | 11.8 | 11.1 | | 8.1 | 7.4 | 140 | |
| 145 | 25.6 | 28.3 | 27.1 | 26.9 | 27.9 | 27.1 | 26.8 | 26.8 | 26.1 | 24.8 | 24.6 | 23.7 | 22.8 | 22.2 | 20.8 | 20.2 | 19.6 | 17.8 | 17 | 16.5 | | 11.8 | 11.1 | | 8.1 | 7.4 | 145 | |
| 150 | 23.2 | 27.7 | 26.9 | 25.4 | 27.9 | 26.9 | 26.3 | 26.7 | 25.9 | 24.7 | 24.6 | 23.9 | 22.8 | 22.2 | 21.1 | 20.2 | 19.6 | 17.9 | 17 | 16.5 | | 11.8 | 11.1 | | 8.1 | 7.4 | 150 | |
| 155 | 20.6 | 26.1 | 26.9 | 23 | 27.5 | 26.7 | 25.1 | 26.6 | 25.8 | 24.6 | 24.4 | 23.9 | 22.7 | 22.2 | 21.3 | 20.2 | 19.6 | 18.1 | 17 | 16.6 | 14.9 | 11.8 | 11.1 | | 8.1 | 7.4 | 155 | |
| 160 | 17.8 | 24 | 26.9 | 20.4 | 26.5 | 26.6 | 22.6 | 26.5 | 25.7 | 24 | 24.3 | 23.8 | 22.7 | 22.2 | 21.5 | 20.2 | 19.6 | 18.3 | 17 | 16.6 | 15 | 11.8 | 11.1 | | 8.1 | 7.4 | 160 | |
| 165 | | 21.4 | 26.1 | 17.2 | 24.7 | 26.6 | 20 | 26.4 | 25.6 | 22.9 | 24.2 | 23.8 | 22.7 | 22.2 | 21.5 | 20.2 | 19.6 | 18.5 | 17 | 16.6 | 15.2 | 11.8 | 11.1 | 10.8 | 8.1 | 7.4 | 165 | |
| 170 | | 18 | 24.4 | | 22.1 | 26.5 | | 25.1 | 25.6 | 20.3 | 24.2 | 23.8 | 21.8 | 22.2 | 21.5 | 20.2 | 19.6 | 18.7 | 17 | 16.6 | 15.4 | 11.8 | 11.1 | 10.8 | 8.1 | 7.4 | 170 | |
| 175 | | | 21.6 | | | 25.8 | | 22.6 | 25.6 | | 24.2 | 23.8 | | 22.2 | 21.6 | | 19.6 | 18.9 | 17 | 16.6 | 15.6 | 11.8 | 11.1 | 10.8 | 8.1 | 7.4 | 7.2 | 175 |
| 180 | | | | | | 23.4 | | 19 | 25.2 | | 24 | 23.8 | | 22.2 | 21.6 | | 19.6 | 19 | | 16.6 | 15.8 | | 11.1 | 10.7 | 8.1 | 7.4 | 7.3 | 180 |
| 185 | | | | | | | | | 24.2 | | | 23.4 | | 22.1 | 21.5 | | 19.6 | 19 | | 16.6 | 15.9 | | 11.1 | 10.6 | | 7.4 | 7.4 | 185 |
| 190 | | | | | | | | | 21.8 | | | 22.6 | | 20.9 | | 19.6 | 19 | | | 16.6 | 15.9 | | 11.1 | 10.6 | | 7.4 | 7.5 | 190 |
| 195 | | | | | | | | | | | | 21.8 | | 20.1 | | | 18.9 | | 16.6 | 15.7 | | 11.1 | 10.6 | | 7.4 | 7.6 | 195 | |
| 200 | | | | | | | | | | | | | | 19.4 | | | | | | 15.5 | | 11.1 | 10.6 | | 7.4 | 7.5 | 200 | |
| 205 | | | | | | | | | | | | | | | | | | | | 15.4 | | | 10.6 | | 7.4 | 7.5 | 205 | |
| 210 | | | | | | | | | | | | | | | | | | | | | 15.1 | | | 10.6 | | 7.5 | 210 | |
| 215 | | | | | | | | | | | | | | | | | | | | | | | | 10.6 | | 7.5 | 215 | |
| 220 | | | | | | | | | | | | | | | | | | | | | | | | | 10.6 | | 7.5 | 220 |
| 225 | | | | | | | | | | | | | | | | | | | | | | | | | | 7.5 | 225 | |

* adapter · pièce d'adaptateur

t_240_004_51001_00_000

Lifting capacities Forces de levage

TN



| ft | 48 + 11.5 ft* | | | 64 + 11.5 ft* | | | 80 + 11.5 ft* | | | 96 + 11.5 ft* | | | 112 + 11.5 ft* | | | 128 + 11.5 ft* | | | 144 + 11.5 ft* | | | 160 + 11.5 ft* | | | 176 + 11.5 ft* | | | ft | | |
|-----|---------------|------|------|---------------|------|------|---------------|------|------|---------------|-----|------|----------------|------|------|----------------|------|------|----------------|------|------|----------------|------|------|----------------|-----|-----|-----|-----|-----|
| | 172 ft | | | 172 ft | | | 172 ft | | | 172 ft | | | 172 ft | | | 172 ft | | | 172 ft | | | 172 ft | | | | | | | | |
| | 82° | 75° | 68° | 82° | 75° | 68° | 82° | 75° | 68° | 82° | 75° | 68° | 82° | 75° | 68° | 82° | 75° | 68° | 82° | 75° | 68° | 82° | 75° | 68° | 82° | 75° | 68° | | | |
| 65 | 29.8 | | | | | | | | | | | | | | | | | | | | | | | | | 65 | | | | |
| 70 | 29.5 | | | 28.1 | | | 26.1 | | | | | | | | | | | | | | | | | | | | 70 | | | |
| 75 | 29.2 | | | 27.9 | | | 25.9 | | | 23.5 | | | 20.8 | | | | | | | | | | | | | | 75 | | | |
| 80 | 28.9 | | | 27.6 | | | 25.7 | | | 23.4 | | | 20.8 | | | 18.1 | | | | | | | | | | | 80 | | | |
| 85 | 28.6 | | | 27.4 | | | 25.6 | | | 23.3 | | | 20.7 | | | 18.1 | | | 15.1 | | | 10.7 | | | | | 85 | | | |
| 90 | 28.3 | | | 27.2 | | | 25.4 | | | 23.1 | | | 20.6 | | | 18 | | | 15.1 | | | 10.6 | | | 7.3 | | 90 | | | |
| 95 | 28 | 27.6 | | 27 | | | 25.2 | | | 23 | | | 20.6 | | | 18 | | | 15.1 | | | 10.6 | | | 7.1 | | 95 | | | |
| 100 | 27.7 | 27.6 | | 26.8 | 26.2 | | 25.1 | 24.3 | | | | 22.9 | | | 20.5 | | | 17.9 | | | 15.1 | | | 10.5 | | 7 | 100 | | | |
| 105 | 27.4 | 27.3 | | 26.6 | 26.3 | | 25 | 24.3 | | | | 22.8 | 22 | | 20.4 | | | 17.9 | | | 15 | | | 10.4 | | 6.9 | 105 | | | |
| 110 | 27.1 | 27 | | 26.4 | 26.1 | | 24.8 | 24.3 | | | | 22.7 | 22 | | 20.4 | 19.6 | | 17.9 | | | 15 | | | 10.3 | | 6.8 | 110 | | | |
| 115 | 26.8 | 26.6 | | 26.3 | 26 | | 24.7 | 24.3 | | | | 22.7 | 22.1 | | 20.3 | 19.7 | | 17.9 | | | 15 | | | 10.2 | | 6.8 | 115 | | | |
| 120 | 26.7 | 26.3 | 25.9 | 26.1 | 25.7 | | 24.6 | 24.2 | | | | 22.6 | 22.1 | | 20.3 | 19.7 | | 17.8 | 17.1 | | 15 | | | 10.1 | | 6.7 | 120 | | | |
| 125 | 26.5 | 25.9 | 25.8 | 25.9 | 25.5 | 24.5 | 24.3 | 24.1 | | | | 22.5 | 22.1 | | 20.3 | 19.8 | | 17.8 | 17.2 | | 15 | 14.2 | | 10 | | 6.6 | 125 | | | |
| 130 | 26.3 | 25.6 | 25.5 | 25.7 | 25.4 | 24.6 | 24.1 | 24 | 22.7 | | | 22.4 | 22 | | 20.3 | 19.8 | | 17.8 | 17.2 | | 15 | 14.3 | | 10 | 9.4 | 6.5 | 130 | | | |
| 135 | 26.1 | 25.4 | 25.1 | 25.4 | 25.2 | 24.7 | 23.9 | 23.8 | 22.8 | | | 22.3 | 22 | | 20.3 | 19.7 | | 17.8 | 17.3 | | 15 | 14.3 | | 9.9 | 9.4 | 6.5 | 5.7 | 135 | | |
| 140 | 25.9 | 25.2 | 24.8 | 25.2 | 25 | 24.6 | 23.7 | 23.7 | 22.9 | | | 22.2 | 21.9 | 20.5 | 20.3 | 19.7 | | 17.8 | 17.3 | | 15 | 14.3 | | 9.9 | 9.3 | 6.4 | 5.7 | 140 | | |
| 145 | 25.6 | 25.1 | 24.5 | 25 | 24.9 | 24.4 | 23.4 | 23.5 | 23 | | | 22 | 21.8 | 20.6 | 20.2 | 19.7 | 18.1 | 17.8 | 17.3 | | 15 | 14.3 | | 9.9 | 9.2 | 6.4 | 5.7 | 145 | | |
| 150 | 24.3 | 25 | 24.3 | 24.5 | 24.8 | 24.2 | 23.2 | 23.3 | 23 | | | 21.8 | 21.7 | 20.8 | 20.1 | 19.6 | 18.3 | 17.8 | 17.3 | | 15 | 14.3 | | 9.9 | 9.2 | 6.4 | 5.7 | 150 | | |
| 155 | 22.8 | 25 | 24.1 | 23.7 | 24.6 | 24 | 23.1 | 23.1 | 22.9 | | | 21.7 | 21.6 | 21 | 20.1 | 19.6 | 18.4 | 17.8 | 17.3 | 15.7 | 15 | 14.3 | | 9.9 | 9.2 | 6.4 | 5.8 | 155 | | |
| 160 | 20.9 | 24.5 | 23.9 | 22.9 | 24.4 | 23.8 | 23 | 22.9 | 22.8 | | | 21.6 | 21.5 | 21.1 | 20 | 19.6 | 18.6 | 17.8 | 17.3 | 15.8 | 15 | 14.3 | | 9.9 | 9.2 | 6.4 | 5.9 | 160 | | |
| 165 | 18.7 | 23.3 | 23.9 | 20.8 | 24 | 23.7 | 22.4 | 22.7 | 22.7 | | | 21.5 | 21.4 | 21.1 | 19.9 | 19.6 | 18.8 | 17.8 | 17.3 | 16 | 15 | 14.3 | 13.1 | 9.9 | 9.2 | 6.4 | 6 | 165 | | |
| 170 | 16.3 | 21.7 | 23.8 | 18.6 | 23.5 | 23.7 | 21 | 22.6 | 22.6 | | | 21.2 | 21.2 | 21.1 | 19.9 | 19.6 | 18.9 | 17.8 | 17.3 | 16.2 | 15 | 14.3 | 13.2 | 9.9 | 9.2 | 9.1 | 6.4 | 6.1 | 170 | |
| 175 | | 19.5 | 23.3 | 16.1 | 22.4 | 23.7 | 19.1 | 22.5 | 22.4 | | | 20.6 | 21.1 | 21 | 19.9 | 19.5 | 19 | 17.8 | 17.3 | 16.4 | 15 | 14.3 | 13.4 | 9.9 | 9.2 | 9.2 | 6.4 | 6.2 | 175 | |
| 180 | | 16.9 | 22.1 | | 20.2 | 23.7 | | 22.2 | 22.3 | | | 18.6 | 21.1 | 20.9 | 19.5 | 19.4 | 19 | 17.8 | 17.3 | 16.6 | 15 | 14.3 | 13.6 | 9.9 | 9.2 | 9.2 | 6.4 | 6.3 | 5.7 | 180 |
| 185 | | | 19.9 | | 17.4 | 23.2 | | 21.3 | 22.2 | | | 21.1 | 20.8 | | 19.4 | 19 | 17.8 | 17.3 | 16.7 | 15 | 14.3 | 13.7 | 9.9 | 9.2 | 9.2 | 6.4 | 6.4 | 5.8 | 185 | |
| 190 | | | 16.5 | | | 21.4 | | 18.8 | 22.2 | | | 21.1 | 20.7 | | 19.4 | 19 | 17.3 | 16.8 | | | 14.3 | 13.9 | 9.9 | 9.2 | 9.2 | 6.4 | 6.5 | 5.9 | 190 | |
| 195 | | | | | | 18.4 | | | 22.2 | | | 19 | 20.7 | | 19.4 | 19 | 17.3 | 16.8 | | | 14.3 | 14.1 | | 9.2 | 9.2 | | 6.5 | 6 | 195 | |
| 200 | | | | | | | | | 21.1 | | | | 20.7 | | 19.3 | 19 | 17.3 | 16.8 | | | 14.3 | 14.1 | | 9.2 | 9.2 | | 6.4 | 6.1 | 200 | |
| 205 | | | | | | | | | | | | 20 | | | | 18.4 | | 16.8 | | | 14.3 | 14.1 | | 9.2 | 9.2 | | 6.4 | 6.2 | 205 | |
| 210 | | | | | | | | | | | | | 20 | | | 17.7 | | 16.7 | | | 14 | | 9.2 | 9.2 | | 6.4 | 6.4 | 210 | | |
| 215 | | | | | | | | | | | | | | | | | | 16.2 | | | 13.9 | | 9.2 | | | 6.4 | 6.5 | 215 | | |
| 220 | | | | | | | | | | | | | | | | | | 15.6 | | | 13.7 | | 9.2 | | | 6.4 | 220 | | | |
| 225 | | | | | | | | | | | | | | | | | | | | | 13.2 | | 9.2 | | | 6.4 | 225 | | | |
| 230 | | | | | | | | | | | | | | | | | | | | | | | 9.2 | | | 6.4 | 230 | | | |
| 235 | | | | | | | | | | | | | | | | | | | | | | | | 9.2 | | | 6.4 | 235 | | |

* adapter · pièce d'adaptateur

t_240_004_51101_00_000

Lifting capacities Forces de levage

TN



| ft | 48 + 11.5 ft* | | | 64 + 11.5 ft* | | | 80 + 11.5 ft* | | | 96 + 11.5 ft* | | | 112 + 11.5 ft* | | | 128 + 11.5 ft* | | | 144 + 11.5 ft* | | | 160 + 11.5 ft* | | | ft |
|-----|---------------|------|------|---------------|------|------|---------------|------|------|---------------|------|------|----------------|------|------|----------------|------|------|----------------|------|------|----------------|-----|-----|-----|
| | 184 ft | | | 184 ft | | | 184 ft | | | 184 ft | | | 184 ft | | | 184 ft | | | 184 ft | | | 184 ft | | | |
| | 82° | 75° | 68° | 82° | 75° | 68° | 82° | 75° | 68° | 82° | 75° | 68° | 82° | 75° | 68° | 82° | 75° | 68° | 82° | 75° | 68° | 82° | 75° | 68° | |
| 70 | 26.1 | | | | | | | | | | | | | | | | | | | | | | | 70 | |
| 75 | 25.9 | | | 24.7 | | | 23 | | | | | | | | | | | | | | | | | 75 | |
| 80 | 25.6 | | | 24.5 | | | 22.9 | | | 20.8 | | | 18.4 | | | | | | | | | | | 80 | |
| 85 | 25.3 | | | 24.3 | | | 22.7 | | | 20.6 | | | 18.3 | | | 15.9 | | | | | | | | 85 | |
| 90 | 25.1 | | | 24.1 | | | 22.6 | | | 20.5 | | | 18.3 | | | 15.9 | | | 13.2 | | | 8.9 | | 90 | |
| 95 | 24.8 | | | 23.9 | | | 22.4 | | | 20.4 | | | 18.2 | | | 15.9 | | | 13.2 | | | 8.8 | | 95 | |
| 100 | 24.6 | 24.1 | | 23.7 | | | 22.3 | | | 20.3 | | | 18.1 | | | 15.8 | | | 13.2 | | | 8.7 | | 100 | |
| 105 | 24.3 | 24.1 | | 23.5 | 23 | | 22.2 | 21.5 | | 20.2 | | | 18.1 | | | 15.8 | | | 13.2 | | | 8.6 | | 105 | |
| 110 | 24 | 24 | | 23.3 | 23 | | 22 | 21.5 | | 20.1 | | | 18 | | | 15.8 | | | 13.1 | | | 8.5 | | 110 | |
| 115 | 23.7 | 23.8 | | 23 | 22.9 | | 21.8 | 21.5 | | 20.1 | 19.4 | | 18 | 17.3 | | 15.7 | | | 13.1 | | | 8.4 | | 115 | |
| 120 | 23.4 | 23.5 | | 22.7 | 22.8 | | 21.7 | 21.5 | | 20 | 19.5 | | 17.9 | 17.3 | | 15.7 | | | 13 | | | 8.3 | | 120 | |
| 125 | 23.1 | 23.2 | 22.6 | 22.5 | 22.6 | | 21.5 | 21.4 | | 19.9 | 19.5 | | 17.9 | 17.4 | | 15.7 | 15 | | 12.9 | | | 8.2 | | 125 | |
| 130 | 22.9 | 22.9 | 22.6 | 22.2 | 22.4 | 21.4 | 21.3 | 21.3 | | 19.8 | 19.5 | | 17.9 | 17.4 | | 15.7 | 15 | | 12.9 | 12 | | 8.2 | | 130 | |
| 135 | 22.6 | 22.7 | 22.5 | 22 | 22.1 | 21.4 | 21 | 21.1 | | 19.7 | 19.4 | | 17.8 | 17.4 | | 15.7 | 15.1 | | 12.8 | 12 | | 8.1 | 7.4 | 135 | |
| 140 | 22.3 | 22.4 | 22.2 | 21.7 | 21.8 | 21.5 | 20.8 | 20.9 | 19.9 | 19.5 | 19.4 | | 17.8 | 17.4 | | 15.7 | 15.1 | | 12.7 | 12 | | 8.1 | 7.4 | 140 | |
| 145 | 22.1 | 22.1 | 21.9 | 21.4 | 21.6 | 21.5 | 20.6 | 20.7 | 20 | 19.3 | 19.3 | 17.9 | 17.7 | 17.3 | | 15.7 | 15.2 | | 12.7 | 12 | | 8.1 | 7.4 | 145 | |
| 150 | 21.8 | 21.9 | 21.7 | 21.2 | 21.3 | 21.4 | 20.4 | 20.5 | 20.1 | 19.1 | 19.1 | 18 | 17.7 | 17.3 | 15.8 | 15.7 | 15.2 | | 12.7 | 12.1 | | 8.1 | 7.5 | 150 | |
| 155 | 21.6 | 21.6 | 21.5 | 21 | 21.1 | 21.2 | 20.2 | 20.2 | 20.2 | 19 | 19 | 18.1 | 17.5 | 17.3 | 16 | 15.7 | 15.1 | | 12.7 | 12.2 | | 8.1 | 7.5 | 155 | |
| 160 | 21.2 | 21.5 | 21.3 | 20.8 | 20.8 | 21 | 20 | 20 | 20.1 | 18.8 | 18.9 | 18.3 | 17.4 | 17.2 | 16.1 | 15.7 | 15.1 | 13.7 | 12.7 | 12.3 | | 8.1 | 7.6 | 160 | |
| 165 | 20.8 | 21.3 | 21.1 | 20.7 | 20.6 | 20.7 | 19.9 | 19.8 | 19.9 | 18.6 | 18.7 | 18.5 | 17.3 | 17.1 | 16.2 | 15.6 | 15.1 | 13.8 | 12.7 | 12.4 | | 8.1 | 7.7 | 165 | |
| 170 | 19.7 | 21.1 | 21 | 20.6 | 20.5 | 20.5 | 19.8 | 19.7 | 19.7 | 18.5 | 18.5 | 18.5 | 17.2 | 17.1 | 16.4 | 15.6 | 15.1 | 13.9 | 12.7 | 12.6 | 11.3 | 8.1 | 7.8 | 170 | |
| 175 | 17.7 | 21 | 20.9 | 19.2 | 20.3 | 20.3 | 19.4 | 19.5 | 19.5 | 18.5 | 18.4 | 18.3 | 17.1 | 17 | 16.5 | 15.5 | 15.1 | 14.1 | 12.7 | 12.7 | 11.4 | 8.1 | 7.9 | 175 | |
| 180 | 15.6 | 20.4 | 20.8 | 17.6 | 20.3 | 20.2 | 18.6 | 19.4 | 19.4 | 18.4 | 18.2 | 18.2 | 17 | 16.9 | 16.6 | 15.5 | 15.1 | 14.2 | 12.7 | 12.7 | 11.6 | 8.1 | 8 | 7.5 | 180 |
| 185 | 13 | 18.5 | 20.8 | 15.6 | 19.9 | 20 | 17.4 | 19.4 | 19.2 | 18.3 | 18.1 | 18.1 | 17 | 16.8 | 16.6 | 15.4 | 15.1 | 14.4 | 12.7 | 12.8 | 11.7 | 8.1 | 8 | 7.6 | 185 |
| 190 | | 16.2 | 20.4 | | 19 | 20 | 15.2 | 19.3 | 19.1 | 17 | 18.1 | 18 | 17 | 16.7 | 16.6 | 15.4 | 15.1 | 14.6 | 12.7 | 12.8 | 11.9 | 8.1 | 8.1 | 7.7 | 190 |
| 195 | | | 18.9 | | 16.9 | 20 | | 19.1 | 19.1 | | 18.1 | 17.9 | 16 | 16.7 | 16.5 | 15.3 | 15.1 | 14.7 | 12.7 | 12.7 | 12 | 8.1 | 8.1 | 7.7 | 195 |
| 200 | | | 16.5 | | | | | 17.3 | 19.1 | | 18.1 | 17.8 | | 16.7 | 16.5 | | 15.1 | 14.8 | | 12.7 | 12.2 | 8.1 | 8.1 | 7.7 | 200 |
| 205 | | | | | | 18 | | | 19.1 | | 17.3 | 17.8 | | 16.7 | 16.4 | | 15.1 | 14.8 | | 12.7 | 12.4 | | 8.1 | 7.7 | 205 |
| 210 | | | | | | | | | 18.8 | | | 17.8 | | 16.7 | 16.4 | | 15.1 | 14.8 | | 12.7 | 12.5 | | 8.1 | 7.8 | 210 |
| 215 | | | | | | | | | | | | 17.8 | | 16.4 | 16.4 | | 15.1 | 14.8 | | 12.7 | 12.5 | | 8.1 | 7.8 | 215 |
| 220 | | | | | | | | | | | | | | | 16.1 | | | 14.9 | | | 12.4 | | 8.1 | 7.8 | 220 |
| 225 | | | | | | | | | | | | | | | 15.6 | | | | | | 12.2 | | | 7.8 | 225 |
| 230 | | | | | | | | | | | | | | | | | | 14.1 | | | 12.2 | | | 7.9 | 230 |
| 235 | | | | | | | | | | | | | | | | | | | | | 11.8 | | | 7.9 | 235 |
| 240 | | | | | | | | | | | | | | | | | | | | | | | 8 | | 240 |

* adapter · pièce d'adaptateur

t_240_004_51201_00_000

Lifting capacities Forces de levage

TN

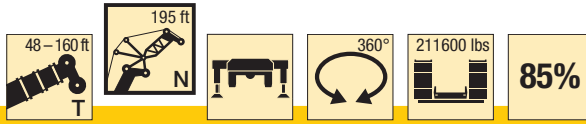

| ft | 48 + 11.5 ft* | | | 64 + 11.5 ft* | | | 80 + 11.5 ft* | | | 96 + 11.5 ft* | | | 112 + 11.5 ft* | | | 128 + 11.5 ft* | | | 144 + 11.5 ft* | | | 160 + 11.5 ft* | | | ft | |
|-----|---------------|------|------|---------------|------|------|---------------|------|------|---------------|------|------|----------------|------|------|----------------|------|------|----------------|------|------|----------------|-----|-----|-----|-----|
| | 195 ft | | | 195 ft | | | 195 ft | | | 195 ft | | | 195 ft | | | 195 ft | | | 195 ft | | | | | | | |
| | 82° | 75° | 68° | 82° | 75° | 68° | 82° | 75° | 68° | 82° | 75° | 68° | 82° | 75° | 68° | 82° | 75° | 68° | 82° | 75° | 68° | 82° | 75° | 68° | | |
| 75 | 22.9 | | | 21.8 | | | | | | | | | | | | | | | | | | | | 75 | | |
| 80 | 22.6 | | | 21.6 | | | 20.2 | | | 18.3 | | | | | | | | | | | | | | 80 | | |
| 85 | 22.4 | | | 21.4 | | | 20.1 | | | 18.2 | | | 16.2 | | | | | | | | | | | 85 | | |
| 90 | 22.2 | | | 21.3 | | | 19.9 | | | 18.1 | | | 16.1 | | | 14 | | | 11.5 | | | | | 90 | | |
| 95 | 22 | | | 21.1 | | | 19.8 | | | 18 | | | 16.1 | | | 14 | | | 11.5 | | | 7.3 | | 95 | | |
| 100 | 21.8 | | | 20.9 | | | 19.7 | | | 17.9 | | | 16 | | | 13.9 | | | 11.6 | | | 7.2 | | 100 | | |
| 105 | 21.5 | 21 | | 20.7 | | | 19.5 | | | 17.9 | | | 15.9 | | | 13.9 | | | 11.5 | | | 7.1 | | 105 | | |
| 110 | 21.3 | 21 | | 20.6 | 20.1 | | 19.4 | | | 17.8 | | | 15.9 | | | 13.9 | | | 11.4 | | | 7 | | 110 | | |
| 115 | 21 | 20.9 | | 20.4 | 20.1 | | 19.3 | 18.8 | | 17.7 | | | 15.8 | | | 13.8 | | | 11.3 | | | 6.9 | | 115 | | |
| 120 | 20.7 | 20.8 | | 20.1 | 20 | | 19.1 | 18.8 | | 17.6 | 17 | | 15.8 | | | 13.8 | | | 11.2 | | | 6.8 | | 120 | | |
| 125 | 20.3 | 20.5 | | 19.8 | 20 | | 18.9 | 18.8 | | 17.5 | 17.1 | | 15.7 | 15.2 | | 13.8 | | | 11.1 | | | 6.7 | | 125 | | |
| 130 | 20.1 | 20.2 | 19.6 | 19.5 | 19.7 | | 18.7 | 18.8 | | 17.4 | 17.1 | | 15.7 | 15.2 | | 13.7 | 13.1 | | 11 | | | 6.6 | | 130 | | |
| 135 | 19.8 | 20 | 19.6 | 19.3 | 19.4 | | 18.5 | 18.6 | | 17.3 | 17.1 | | 15.6 | 15.3 | | 13.7 | 13.2 | | 11 | 10.2 | | 6.6 | | 135 | | |
| 140 | 19.6 | 19.7 | 19.6 | 19.1 | 19.2 | 18.7 | 18.3 | 18.4 | | 17.2 | 17 | | 15.6 | 15.3 | | 13.7 | 13.2 | | 10.9 | 10.2 | | 6.6 | 6 | 140 | | |
| 145 | 19.3 | 19.4 | 19.6 | 18.8 | 19 | 18.7 | 18.1 | 18.2 | 17.3 | 17 | 17 | | 15.5 | 15.3 | | 13.7 | 13.3 | | 10.9 | 10.2 | | 6.5 | 6 | 145 | | |
| 150 | 19.1 | 19.2 | 19.3 | 18.6 | 18.7 | 18.7 | 17.9 | 18 | 17.4 | 16.8 | 16.9 | 15.6 | 15.5 | 15.2 | | 13.7 | 13.3 | | 10.9 | 10.3 | | 6.5 | 6 | 150 | | |
| 155 | 18.9 | 18.9 | 19.1 | 18.4 | 18.5 | 18.6 | 17.7 | 17.8 | 17.5 | 16.6 | 16.7 | 15.7 | 15.4 | 15.2 | | 13.7 | 13.2 | | 10.9 | 10.3 | | 6.5 | 6 | 155 | | |
| 160 | 18.7 | 18.7 | 18.8 | 18.2 | 18.3 | 18.4 | 17.5 | 17.6 | 17.5 | 16.5 | 16.6 | 15.7 | 15.3 | 15.1 | 13.9 | 13.7 | 13.2 | | 10.9 | 10.4 | | 6.5 | 6.1 | 160 | | |
| 165 | 18.5 | 18.5 | 18.6 | 18 | 18.1 | 18.2 | 17.3 | 17.4 | 17.5 | 16.3 | 16.4 | 15.9 | 15.1 | 15.1 | 14 | 13.7 | 13.2 | 11.9 | 10.9 | 10.5 | | 6.5 | 6.2 | 165 | | |
| 170 | 18.4 | 18.3 | 18.4 | 17.8 | 17.9 | 17.9 | 17.1 | 17.2 | 17.3 | 16.2 | 16.3 | 16 | 15 | 15 | 14.1 | 13.6 | 13.2 | 12 | 10.9 | 10.6 | | 6.5 | 6.3 | 170 | | |
| 175 | 18.2 | 18.2 | 18.2 | 17.7 | 17.7 | 17.7 | 17 | 17 | 17.1 | 16 | 16.1 | 16.1 | 14.9 | 14.9 | 14.2 | 13.5 | 13.2 | 12.1 | 10.9 | 10.8 | 9.8 | 6.5 | 6.4 | 175 | | |
| 180 | 17.5 | 18.1 | 18 | 17.6 | 17.6 | 17.6 | 16.9 | 16.9 | 16.9 | 16 | 15.9 | 16 | 14.8 | 14.7 | 14.3 | 13.5 | 13.2 | 12.2 | 10.9 | 10.9 | 9.9 | 6.5 | 6.5 | 180 | | |
| 185 | 16 | 18 | 17.9 | 16.8 | 17.4 | 17.4 | 16.7 | 16.7 | 16.8 | 15.9 | 15.8 | 15.8 | 14.8 | 14.6 | 14.4 | 13.4 | 13.2 | 12.3 | 10.9 | 10.9 | 10 | 6.5 | 6.6 | 6.1 | 185 | |
| 190 | 14.3 | 17.6 | 17.8 | 15.9 | 17.3 | 17.3 | 16.4 | 16.6 | 16.6 | 15.9 | 15.7 | 15.7 | 14.7 | 14.5 | 14.4 | 13.4 | 13.2 | 12.5 | 10.9 | 11 | 10.1 | 6.5 | 6.6 | 6.2 | 190 | |
| 195 | 12.2 | 16.6 | 17.7 | 14.3 | 17.2 | 17.2 | 15.8 | 16.6 | 16.5 | 15.9 | 15.6 | 15.6 | 14.7 | 14.5 | 14.4 | 13.3 | 13.2 | 12.6 | 10.9 | 11.1 | 10.2 | 6.5 | 6.5 | 6.3 | 195 | |
| 200 | | 15 | 17.6 | | 16.9 | 17.1 | 14.1 | 16.6 | 16.4 | 15.2 | 15.6 | 15.4 | 14.7 | 14.4 | 14.3 | 13.3 | 13.1 | 12.8 | 10.9 | 11.1 | 10.3 | 6.5 | 6.5 | 6.4 | 200 | |
| 205 | | 12.4 | 17.1 | | 15.6 | 17.1 | | 16.6 | 16.3 | | 15.5 | 15.4 | 14.4 | 14.4 | 14.2 | 13.3 | 13.1 | 12.9 | 10.9 | 11.1 | 10.5 | 6.5 | 6.5 | 6.5 | 205 | |
| 210 | | | 15.4 | | | 17.1 | | 15.7 | 16.3 | | 15.5 | 15.3 | | 14.4 | 14.2 | | 13.1 | 12.8 | 10.9 | 11 | 10.7 | 6.5 | 6.5 | 6.6 | 210 | |
| 215 | | | | | | 16.5 | | | 16.3 | | 15.4 | 15.3 | | 14.4 | 14.2 | | 13.1 | 12.8 | | 11 | 10.8 | | 6.5 | 6.5 | 215 | |
| 220 | | | | | | | | | 16.3 | | | 15.3 | | 14.4 | 14.1 | | 13.1 | 12.8 | | 11 | 10.9 | | 6.5 | 6.5 | 220 | |
| 225 | | | | | | | | 15.1 | | | | 15.3 | | | | 14.1 | | 13.1 | 12.8 | | 11 | 11 | | 6.5 | 6.5 | 225 |
| 230 | | | | | | | | | | | | 15.3 | | | | 14.1 | | 12.8 | | 11 | 11 | | 6.5 | 6.5 | 230 | |
| 235 | | | | | | | | | | | | | | | 14.1 | | 12.8 | | | 11 | | 6.5 | 6.5 | 235 | | |
| 240 | | | | | | | | | | | | | | | | | 12.8 | | | 10.9 | | | 6.5 | 240 | | |
| 245 | | | | | | | | | | | | | | | | | | | | 10.7 | | | | 6.5 | 245 | |
| 250 | | | | | | | | | | | | | | | | | | | | | | | | 6.5 | 250 | |
| 255 | | | | | | | | | | | | | | | | | | | | | | | | | 6.5 | 255 |

* adapter · pièce d'adaptateur

t_240_004_51301_00_000

Lifting capacities Forces de levage

TN

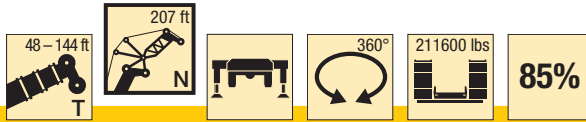

| ft | 48 + 11.5 ft* | | | 64 + 11.5 ft* | | | 80 + 11.5 ft* | | | 96 + 11.5 ft* | | | 112 + 11.5 ft* | | | 128 + 11.5 ft* | | | 144 + 11.5 ft* | | | ft |
|-----|---------------|------|------|---------------|------|------|---------------|------|------|---------------|------|------|----------------|------|------|----------------|------|------|----------------|-----|-----|-----|
| | 207 ft | | | 207 ft | | | 207 ft | | | 207 ft | | | 207 ft | | | 207 ft | | | 207 ft | | | |
| | 82° | 75° | 68° | 82° | 75° | 68° | 82° | 75° | 68° | 82° | 75° | 68° | 82° | 75° | 68° | 82° | 75° | 68° | 82° | 75° | 68° | |
| 80 | 20.2 | | | 19.2 | | | | | | | | | | | | | | | | | | 80 |
| 85 | 20 | | | 19.1 | | | 17.8 | | | 16.1 | | | | | | | | | | | | 85 |
| 90 | 19.8 | | | 18.9 | | | 17.7 | | | 16 | | | 14.2 | | | 12.1 | | | | | | 90 |
| 95 | 19.6 | | | 18.7 | | | 17.5 | | | 15.9 | | | 14.1 | | | 12.1 | | | 9.8 | | | 95 |
| 100 | 19.4 | | | 18.6 | | | 17.4 | | | 15.8 | | | 14.1 | | | 12.1 | | | 9.8 | | | 100 |
| 105 | 19.1 | | | 18.4 | | | 17.3 | | | 15.8 | | | 14 | | | 12.1 | | | 9.7 | | | 105 |
| 110 | 18.9 | 18.5 | | 18.2 | | | 17.2 | | | 15.7 | | | 14 | | | 12.1 | | | 9.6 | | | 110 |
| 115 | 18.6 | 18.4 | | 18.1 | 17.7 | | 17.1 | | | 15.6 | | | 13.9 | | | 12.1 | | | 9.4 | | | 115 |
| 120 | 18.4 | 18.4 | | 17.8 | 17.6 | | 16.9 | 16.5 | | 15.5 | | | 13.9 | | | 12 | | | 9.3 | | | 120 |
| 125 | 18.1 | 18.2 | | 17.6 | 17.6 | | 16.7 | 16.5 | | 15.4 | 14.9 | | 13.8 | | | 12 | | | 9.3 | | | 125 |
| 130 | 17.8 | 18 | | 17.3 | 17.5 | | 16.5 | 16.5 | | 15.3 | 14.9 | | 13.7 | 13.3 | | 12 | | | 9.2 | | | 130 |
| 135 | 17.5 | 17.7 | 17.1 | 17.1 | 17.3 | | 16.3 | 16.5 | | 15.2 | 15 | | 13.7 | 13.3 | | 11.9 | 11.3 | | 9.2 | | | 135 |
| 140 | 17.3 | 17.4 | 17.1 | 16.8 | 17 | | 16.1 | 16.3 | | 15.1 | 15 | | 13.7 | 13.3 | | 11.9 | 11.3 | | 9.2 | 8.4 | | 140 |
| 145 | 17 | 17.2 | 17.1 | 16.6 | 16.8 | 16.2 | 15.9 | 16.1 | | 15 | 14.9 | | 13.6 | 13.3 | | 11.9 | 11.4 | | 9.2 | 8.4 | | 145 |
| 150 | 16.8 | 16.9 | 17.1 | 16.4 | 16.5 | 16.3 | 15.7 | 15.9 | 15.1 | 14.8 | 14.9 | | 13.5 | 13.3 | | 11.8 | 11.4 | | 9.2 | 8.5 | | 150 |
| 155 | 16.6 | 16.7 | 16.9 | 16.1 | 16.3 | 16.3 | 15.5 | 15.7 | 15.1 | 14.6 | 14.7 | | 13.4 | 13.2 | | 11.8 | 11.4 | | 9.2 | 8.5 | | 155 |
| 160 | 16.4 | 16.5 | 16.6 | 15.9 | 16 | 16.2 | 15.3 | 15.4 | 15.2 | 14.4 | 14.6 | 13.6 | 13.3 | 13.2 | | 11.8 | 11.5 | | 9.2 | 8.6 | | 160 |
| 165 | 16.2 | 16.2 | 16.4 | 15.7 | 15.8 | 16 | 15.1 | 15.2 | 15.2 | 14.2 | 14.4 | 13.7 | 13.2 | 13.1 | 12 | 11.8 | 11.5 | | 9.2 | 8.7 | | 165 |
| 170 | 16 | 16 | 16.1 | 15.6 | 15.6 | 15.8 | 15 | 15.1 | 15.1 | 14.1 | 14.2 | 13.7 | 13 | 13 | 12.1 | 11.8 | 11.4 | | 9.2 | 8.7 | | 170 |
| 175 | 15.8 | 15.8 | 15.9 | 15.4 | 15.4 | 15.6 | 14.8 | 14.9 | 15 | 13.9 | 14 | 13.8 | 12.9 | 12.9 | 12.2 | 11.7 | 11.4 | 10.3 | 9.2 | 8.8 | | 175 |
| 180 | 15.7 | 15.7 | 15.7 | 15.3 | 15.3 | 15.4 | 14.7 | 14.7 | 14.8 | 13.8 | 13.9 | 13.8 | 12.8 | 12.8 | 12.3 | 11.6 | 11.4 | 10.4 | 9.2 | 8.9 | 8.2 | 180 |
| 185 | 15.6 | 15.5 | 15.6 | 15.2 | 15.2 | 15.2 | 14.6 | 14.5 | 14.6 | 13.7 | 13.7 | 13.7 | 12.7 | 12.7 | 12.4 | 11.5 | 11.4 | 10.5 | 9.2 | 9.1 | 8.3 | 185 |
| 190 | 15.1 | 15.4 | 15.4 | 15 | 15 | 15 | 14.5 | 14.4 | 14.5 | 13.7 | 13.6 | 13.6 | 12.6 | 12.6 | 12.4 | 11.4 | 11.4 | 10.6 | 9.2 | 9.2 | 8.4 | 190 |
| 195 | 14 | 15.3 | 15.3 | 14.6 | 14.9 | 14.9 | 14.4 | 14.3 | 14.3 | 13.6 | 13.5 | 13.5 | 12.6 | 12.5 | 12.4 | 11.4 | 11.3 | 10.7 | 9.2 | 9.2 | 8.5 | 195 |
| 200 | 12.9 | 15.2 | 15.2 | 14.1 | 14.8 | 14.8 | 14.4 | 14.2 | 14.2 | 13.6 | 13.4 | 13.4 | 12.5 | 12.4 | 12.4 | 11.4 | 11.3 | 10.8 | 9.2 | 9.3 | 8.6 | 200 |
| 205 | 11.2 | 14.6 | 15.2 | 13 | 14.8 | 14.7 | 14.1 | 14.2 | 14.1 | 13.6 | 13.4 | 13.3 | 12.5 | 12.3 | 12.3 | 11.4 | 11.2 | 10.9 | 9.2 | 9.4 | 8.7 | 205 |
| 210 | | 13.7 | 15.1 | 11.3 | 14.8 | 14.7 | 12.7 | 14.2 | 14 | 13.3 | 13.3 | 13.2 | 12.5 | 12.3 | 12.2 | 11.4 | 11.2 | 11 | 9.2 | 9.3 | 8.8 | 210 |
| 215 | | 11.6 | 15 | | 14.1 | 14.6 | | 14.2 | 14 | 12.2 | 13.3 | 13.2 | 12.3 | 12.3 | 12.2 | 11.3 | 11.1 | 11 | 9.2 | 9.3 | 9 | 215 |
| 220 | | | 14.1 | | | 14.6 | | 13.8 | 14 | | 13.3 | 13.1 | | 12.3 | 12.1 | 10.8 | 11.1 | 11 | 9.1 | 9.3 | 9.2 | 220 |
| 225 | | | | | 14.4 | | | 12.4 | 13.9 | | 13.3 | 13.1 | | 12.3 | 12.1 | | 11.1 | 10.9 | | 9.3 | 9.3 | 225 |
| 230 | | | | | | | | | 13.9 | | | 13.1 | | 12.3 | 12 | | 11.1 | 10.9 | | 9.3 | 9.3 | 230 |
| 235 | | | | | | | | | 13.8 | | | 13.1 | | 12 | | | 11.1 | 10.9 | | 9.3 | 9.3 | 235 |
| 240 | | | | | | | | | | | | 13.1 | | 12 | | | | 10.9 | | 9.3 | 9.3 | 240 |
| 245 | | | | | | | | | | | | | | 12 | | | | 10.9 | | | 9.3 | 245 |
| 250 | | | | | | | | | | | | | | | | | | 10.9 | | | 9.3 | 250 |
| 255 | | | | | | | | | | | | | | | | | | | | | 9.3 | 255 |
| 260 | | | | | | | | | | | | | | | | | | | | | 9.2 | 260 |

* adapter · pièce d'adaptateur

t_240_004_51401_00_000

Lifting capacities Forces de levage

TN



| ft | 48 + 11.5 ft* | | | 64 + 11.5 ft* | | | 80 + 11.5 ft* | | | 96 + 11.5 ft* | | | 112 + 11.5 ft* | | | 128 + 11.5 ft* | | | 144 + 11.5 ft* | | | ft |
|-----|---------------|------|------|---------------|------|------|---------------|------|------|---------------|------|------|----------------|------|------|----------------|------|-----|----------------|-----|-----|-----|
| | 218 ft | | | 218 ft | | | 218 ft | | | 218 ft | | | 218 ft | | | 218 ft | | | 218 ft | | | |
| | 82° | 75° | 68° | 82° | 75° | 68° | 82° | 75° | 68° | 82° | 75° | 68° | 82° | 75° | 68° | 82° | 75° | 68° | 82° | 75° | 68° | |
| 80 | 17.9 | | | | | | | | | | | | | | | | | | | | | 80 |
| 85 | 17.8 | | | 17 | | | 15.7 | | | | | | | | | | | | | | | 85 |
| 90 | 17.7 | | | 16.9 | | | 15.7 | | | 14.2 | | | 12.3 | | | | | | | | | 90 |
| 95 | 17.5 | | | 16.7 | | | 15.6 | | | 14.1 | | | 12.3 | | | 10.4 | | | | | | 95 |
| 100 | 17.3 | | | 16.6 | | | 15.5 | | | 14 | | | 12.3 | | | 10.4 | | | 8.1 | | | 100 |
| 105 | 17.1 | | | 16.4 | | | 15.4 | | | 14 | | | 12.2 | | | 10.4 | | | 8 | | | 105 |
| 110 | 16.9 | | | 16.3 | | | 15.3 | | | 13.9 | | | 12.2 | | | 10.4 | | | 7.9 | | | 110 |
| 115 | 16.7 | 16.4 | | 16.1 | | | 15.2 | | | 13.8 | | | 12.2 | | | 10.4 | | | 7.8 | | | 115 |
| 120 | 16.4 | 16.3 | | 15.9 | 15.6 | | 15.1 | | | 13.7 | | | 12.2 | | | 10.4 | | | 7.6 | | | 120 |
| 125 | 16.2 | 16.2 | | 15.7 | 15.6 | | 15 | 14.5 | | 13.6 | | | 12.1 | | | 10.4 | | | 7.6 | | | 125 |
| 130 | 16 | 16.1 | | 15.5 | 15.5 | | 14.8 | 14.5 | | 13.6 | 13.1 | | 12.1 | | | 10.3 | | | 7.5 | | | 130 |
| 135 | 15.7 | 15.8 | | 15.3 | 15.4 | | 14.6 | 14.5 | | 13.5 | 13.1 | | 12 | 11.5 | | 10.3 | | | 7.4 | | | 135 |
| 140 | 15.4 | 15.6 | | 15 | 15.2 | | 14.4 | 14.5 | | 13.3 | 13.1 | | 12 | 11.5 | | 10.3 | 9.8 | | 7.4 | | | 140 |
| 145 | 15.2 | 15.4 | 15.1 | 14.8 | 15 | | 14.2 | 14.4 | | 13.2 | 13.1 | | 12 | 11.6 | | 10.3 | 9.9 | | 7.4 | 6.8 | | 145 |
| 150 | 15 | 15.1 | 15.1 | 14.6 | 14.7 | 14.2 | 14 | 14.2 | | 13.1 | 13.1 | | 11.9 | 11.6 | | 10.3 | 9.9 | | 7.4 | 6.8 | | 150 |
| 155 | 14.8 | 14.9 | 15 | 14.4 | 14.5 | 14.3 | 13.8 | 14 | 13.2 | 13 | 13 | | 11.9 | 11.5 | | 10.3 | 9.9 | | 7.4 | 6.9 | | 155 |
| 160 | 14.6 | 14.7 | 14.8 | 14.2 | 14.3 | 14.3 | 13.6 | 13.8 | 13.2 | 12.8 | 12.9 | | 11.7 | 11.5 | | 10.2 | 9.9 | | 7.4 | 7 | | 160 |
| 165 | 14.4 | 14.5 | 14.6 | 14 | 14.1 | 14.2 | 13.4 | 13.6 | 13.3 | 12.6 | 12.7 | 11.9 | 11.6 | 11.5 | | 10.2 | 9.9 | | 7.4 | 7 | | 165 |
| 170 | 14.2 | 14.3 | 14.4 | 13.8 | 13.9 | 14 | 13.2 | 13.3 | 13.3 | 12.4 | 12.6 | 11.9 | 11.5 | 11.4 | 10.4 | 10.2 | 9.9 | | 7.4 | 7.1 | | 170 |
| 175 | 14 | 14.1 | 14.2 | 13.7 | 13.7 | 13.8 | 13.1 | 13.1 | 13.2 | 12.3 | 12.4 | 12 | 11.3 | 11.3 | 10.5 | 10.2 | 9.9 | | 7.4 | 7.2 | | 175 |
| 180 | 13.8 | 13.9 | 14 | 13.5 | 13.5 | 13.6 | 13 | 13 | 13.1 | 12.2 | 12.2 | 12 | 11.2 | 11.2 | 10.6 | 10.1 | 9.9 | 8.8 | 7.4 | 7.3 | | 180 |
| 185 | 13.7 | 13.7 | 13.8 | 13.3 | 13.4 | 13.4 | 12.8 | 12.8 | 13 | 12.1 | 12.1 | 12 | 11.2 | 11.2 | 10.6 | 10.1 | 9.9 | 8.8 | 7.4 | 7.3 | | 185 |
| 190 | 13.6 | 13.6 | 13.6 | 13.2 | 13.2 | 13.3 | 12.7 | 12.7 | 12.8 | 11.9 | 12 | 12 | 11.1 | 11.1 | 10.7 | 10 | 9.9 | 8.9 | 7.4 | 7.4 | 7 | 190 |
| 195 | 13.5 | 13.5 | 13.5 | 13.1 | 13.1 | 13.1 | 12.6 | 12.6 | 12.7 | 11.9 | 11.9 | 11.9 | 11 | 11 | 10.8 | 9.9 | 9.8 | 9 | 7.4 | 7.5 | 7.1 | 195 |
| 200 | 13.2 | 13.4 | 13.4 | 13.1 | 13 | 13 | 12.5 | 12.5 | 12.5 | 11.8 | 11.8 | 11.8 | 10.9 | 10.9 | 10.8 | 9.9 | 9.8 | 9.1 | 7.4 | 7.6 | 7.2 | 200 |
| 205 | 12.4 | 13.3 | 13.3 | 12.8 | 12.9 | 12.9 | 12.5 | 12.4 | 12.4 | 11.8 | 11.7 | 11.7 | 10.9 | 10.8 | 10.8 | 9.8 | 9.7 | 9.3 | 7.4 | 7.6 | 7.3 | 205 |
| 210 | 11.5 | 13.2 | 13.2 | 12.5 | 12.8 | 12.8 | 12.5 | 12.3 | 12.3 | 11.7 | 11.6 | 11.6 | 10.9 | 10.7 | 10.7 | 9.8 | 9.7 | 9.4 | 7.4 | 7.5 | 7.3 | 210 |
| 215 | 10.2 | 12.8 | 13.1 | 11.7 | 12.8 | 12.7 | 12.4 | 12.3 | 12.2 | 11.7 | 11.5 | 11.5 | 10.9 | 10.6 | 10.6 | 9.8 | 9.6 | 9.4 | 7.4 | 7.5 | 7.4 | 215 |
| 220 | | 12.4 | 13.1 | 10.2 | 12.8 | 12.7 | 11.5 | 12.2 | 12.1 | 11.6 | 11.5 | 11.4 | 10.8 | 10.6 | 10.6 | 9.7 | 9.6 | 9.5 | 7.4 | 7.5 | 7.5 | 220 |
| 225 | | 10.6 | 13.1 | | 12.5 | 12.6 | | 12.2 | 12.1 | 11.1 | 11.5 | 11.4 | 10.5 | 10.6 | 10.5 | 9.5 | 9.6 | 9.5 | 7.4 | 7.5 | 7.5 | 225 |
| 230 | | | 12.7 | | 11.2 | 12.6 | | 12.2 | 12.1 | | 11.5 | 11.3 | | 10.6 | 10.4 | 9 | 9.6 | 9.4 | 7.4 | 7.5 | 7.6 | 230 |
| 235 | | | 10.7 | | | 12.6 | | 11.4 | 12 | | 11.5 | 11.3 | | 10.6 | 10.4 | | 9.6 | 9.4 | | 7.5 | 7.5 | 235 |
| 240 | | | | | | 12 | | | 12 | | 11.3 | 11.3 | | 10.6 | 10.4 | | 9.6 | 9.3 | | 7.5 | 7.5 | 240 |
| 245 | | | | | | | | | 12 | | | 11.3 | | 10.6 | 10.3 | | 9.6 | 9.3 | | 7.5 | 7.5 | 245 |
| 250 | | | | | | | | | | | | 11.3 | | | | | 9.3 | | 7.5 | 7.5 | 250 | |
| 255 | | | | | | | | | | | | | | | | | 10.3 | | | 7.5 | 7.5 | 255 |
| 260 | | | | | | | | | | | | | | | | | | 9.3 | | 7.5 | 260 | |
| 265 | | | | | | | | | | | | | | | | | | 9.3 | | 7.5 | 265 | |
| 270 | | | | | | | | | | | | | | | | | | | 9.3 | | 7.5 | 270 |

* adapter · pièce d'adaptateur

t_240_004_51501_00_000

Lifting capacities Forces de levage

TN



| ft | 48 + 11.5 ft* | | | 64 + 11.5 ft* | | | 80 + 11.5 ft* | | | 96 + 11.5 ft* | | | 112 + 11.5 ft* | | | 128 + 11.5 ft* | | | 144 + 11.5 ft* | | | ft | |
|-----|---------------|------|------|---------------|------|------|---------------|------|------|---------------|------|------|----------------|-----|-----|----------------|-----|-----|----------------|-----|-----|-----|-----|
| | 230 ft | | | 230 ft | | | 230 ft | | | 230 ft | | | 230 ft | | | 230 ft | | | 230 ft | | | | |
| | 82° | 75° | 68° | 82° | 75° | 68° | 82° | 75° | 68° | 82° | 75° | 68° | 82° | 75° | 68° | 82° | 75° | 68° | 82° | 75° | 68° | | |
| 85 | 15.8 | | | | | | | | | | | | | | | | | | | | | 85 | |
| 90 | 15.6 | | | 14.9 | | | 13.7 | | | | | | | | | | | | | | | 90 | |
| 95 | 15.5 | | | 14.7 | | | 13.7 | | | 12.2 | | | 10.5 | | | | | | | | | 95 | |
| 100 | 15.3 | | | 14.6 | | | 13.6 | | | 12.1 | | | 10.5 | | | 8.8 | | | 6.5 | | | 100 | |
| 105 | 15.1 | | | 14.5 | | | 13.5 | | | 12.1 | | | 10.4 | | | 8.8 | | | 6.4 | | | 105 | |
| 110 | 14.9 | | | 14.3 | | | 13.4 | | | 12 | | | 10.4 | | | 8.8 | | | 6.2 | | | 110 | |
| 115 | 14.7 | | | 14.2 | | | 13.3 | | | 12 | | | 10.4 | | | 8.7 | | | 6.1 | | | 115 | |
| 120 | 14.5 | 14.2 | | 14 | | | 13.2 | | | 11.9 | | | 10.4 | | | 8.7 | | | 6 | | | 120 | |
| 125 | 14.2 | 14.2 | | 13.8 | 13.5 | | 13.1 | | | 11.9 | | | 10.3 | | | 8.7 | | | 5.9 | | | 125 | |
| 130 | 14 | 14.1 | | 13.6 | 13.5 | | 13 | 12.6 | | 11.8 | | | 10.3 | | | 8.7 | | | 5.9 | | | 130 | |
| 135 | 13.8 | 13.9 | | 13.4 | 13.4 | | 12.8 | 12.6 | | 11.7 | 11.3 | | 10.3 | | | 8.6 | | | 5.9 | | | 135 | |
| 140 | 13.5 | 13.7 | | 13.1 | 13.3 | | 12.6 | 12.5 | | 11.6 | 11.2 | | 10.3 | | | 8.6 | | | 5.8 | | | 140 | |
| 145 | 13.3 | 13.4 | | 12.9 | 13.1 | | 12.4 | 12.5 | | 11.5 | 11.2 | | 10.2 | 9.9 | | 8.6 | 8.2 | | 5.8 | | | 145 | |
| 150 | 13 | 13.2 | 13 | 12.7 | 12.9 | | 12.2 | 12.4 | | 11.4 | 11.2 | | 10.2 | 9.9 | | 8.6 | 8.2 | | 5.8 | 5.3 | | 150 | |
| 155 | 12.8 | 13 | 13 | 12.5 | 12.7 | 12.3 | 12 | 12.2 | | 11.2 | 11.2 | | 10.2 | 9.9 | | 8.6 | 8.3 | | 5.8 | 5.3 | | 155 | |
| 160 | 12.5 | 12.7 | 12.9 | 12.2 | 12.4 | 12.3 | 11.8 | 12 | | 11.1 | 11.1 | | 10.1 | 9.9 | | 8.6 | 8.3 | | 5.8 | 5.4 | | 160 | |
| 165 | 12.2 | 12.4 | 12.7 | 12 | 12.2 | 12.3 | 11.6 | 11.8 | 11.3 | 10.9 | 11 | | 10.1 | 9.9 | | 8.6 | 8.4 | | 5.8 | 5.4 | | 165 | |
| 170 | 12 | 12.2 | 12.4 | 11.7 | 12 | 12.2 | 11.4 | 11.6 | 11.4 | 10.8 | 10.9 | 10.1 | 9.9 | 9.8 | | 8.6 | 8.4 | | 5.8 | 5.5 | | 170 | |
| 175 | 11.7 | 11.9 | 12.2 | 11.5 | 11.7 | 12 | 11.2 | 11.4 | 11.4 | 10.6 | 10.7 | 10.2 | 9.8 | 9.7 | | 8.6 | 8.4 | | 5.8 | 5.5 | | 175 | |
| 180 | 11.5 | 11.7 | 11.9 | 11.3 | 11.5 | 11.8 | 11 | 11.2 | 11.4 | 10.4 | 10.6 | 10.2 | 9.6 | 9.6 | 8.8 | 8.6 | 8.4 | | 5.8 | 5.6 | | 180 | |
| 185 | 11.3 | 11.5 | 11.7 | 11.1 | 11.3 | 11.5 | 10.8 | 11 | 11.2 | 10.3 | 10.4 | 10.2 | 9.5 | 9.5 | 8.9 | 8.5 | 8.4 | 7.3 | 5.8 | 5.7 | | 185 | |
| 190 | 11.1 | 11.3 | 11.4 | 10.9 | 11.1 | 11.3 | 10.6 | 10.8 | 11.1 | 10.1 | 10.3 | 10.2 | 9.4 | 9.4 | 9 | 8.4 | 8.4 | 7.4 | 5.8 | 5.7 | | 190 | |
| 195 | 11 | 11.1 | 11.2 | 10.7 | 10.9 | 11.1 | 10.4 | 10.6 | 10.9 | 9.9 | 10.1 | 10.2 | 9.3 | 9.3 | 9 | 8.4 | 8.3 | 7.4 | 5.8 | 5.8 | 5.5 | 195 | |
| 200 | 10.9 | 10.9 | 11 | 10.6 | 10.7 | 10.9 | 10.3 | 10.4 | 10.7 | 9.8 | 9.9 | 10.1 | 9.1 | 9.2 | 9.1 | 8.3 | 8.3 | 7.5 | 5.8 | 5.9 | 5.6 | 200 | |
| 205 | 10.7 | 10.8 | 10.9 | 10.5 | 10.6 | 10.7 | 10.2 | 10.3 | 10.5 | 9.7 | 9.8 | 9.9 | 9 | 9.1 | 9.1 | 8.2 | 8.2 | 7.6 | 5.8 | 6 | 5.7 | 205 | |
| 210 | 10.5 | 10.6 | 10.7 | 10.4 | 10.4 | 10.5 | 10 | 10.1 | 10.3 | 9.6 | 9.7 | 9.8 | 8.9 | 9 | 9.1 | 8.2 | 8.2 | 7.7 | 5.8 | 6 | 5.8 | 210 | |
| 215 | 10.3 | 10.5 | 10.6 | 10.3 | 10.3 | 10.4 | 10 | 10 | 10.1 | 9.5 | 9.5 | 9.7 | 8.9 | 8.9 | 9 | 8.1 | 8.1 | 7.8 | 5.8 | 6 | 5.8 | 215 | |
| 220 | 10 | 10.4 | 10.4 | 10.3 | 10.2 | 10.2 | 9.9 | 9.9 | 10 | 9.5 | 9.4 | 9.6 | 8.8 | 8.8 | 8.9 | 8.1 | 8 | 7.8 | 5.8 | 6 | 5.9 | 220 | |
| 225 | 9 | 10.4 | 10.4 | 10 | 10.1 | 10.1 | 9.9 | 9.8 | 9.9 | 9.4 | 9.3 | 9.4 | 8.8 | 8.7 | 8.8 | 8 | 8 | 7.8 | 5.8 | 6 | 6 | 225 | |
| 230 | 7.7 | 10.4 | 10.3 | 9 | 10.1 | 10 | 9.5 | 9.7 | 9.7 | 9.4 | 9.3 | 9.3 | 8.8 | 8.7 | 8.7 | 7.9 | 7.9 | 7.8 | 5.8 | 6 | 6 | 230 | |
| 235 | | 9.4 | 10.3 | | 10.1 | 10 | 8.7 | 9.7 | 9.7 | 9.4 | 9.2 | 9.2 | 8.6 | 8.6 | 8.6 | 7.8 | 7.9 | 7.8 | 5.8 | 6 | 6 | 235 | |
| 240 | | | 10.3 | | 9.6 | 10 | | 9.7 | 9.6 | | | 9.2 | 9.1 | 8 | 8.6 | 8.6 | | | 6 | 6 | | 240 | |
| 245 | | | 9.7 | | 10 | | | 9.7 | 9.6 | | | 9.2 | 9.1 | | 8.6 | 8.5 | | 7.8 | 7.7 | | 6 | 6 | 245 |
| 250 | | | | | 10 | | | | 9.6 | | | 9.2 | 9.1 | | 8.6 | 8.4 | | 7.8 | 7.7 | | 6 | 6 | 250 |
| 255 | | | | | | | | | 9.6 | | | 9 | | 8.6 | 8.4 | | 7.8 | 7.7 | | 6 | 6 | 255 | |
| 260 | | | | | | | | | | | | 9 | | | 8.4 | | 7.8 | 7.7 | | 6 | 6 | 260 | |
| 265 | | | | | | | | | | | | 9 | | | 8.4 | | | 7.6 | | 6 | 6 | 265 | |
| 270 | | | | | | | | | | | | | | | 8.4 | | | 7.6 | | 6 | 6 | 270 | |
| 275 | | | | | | | | | | | | | | | | | | 7.6 | | 6 | 6 | 275 | |
| 280 | | | | | | | | | | | | | | | | | | | | 6 | 6 | 280 | |

* adapter · pièce d'adaptateur

t_240_004_51601_00_000

Lifting heights Hauteurs de levage

TN

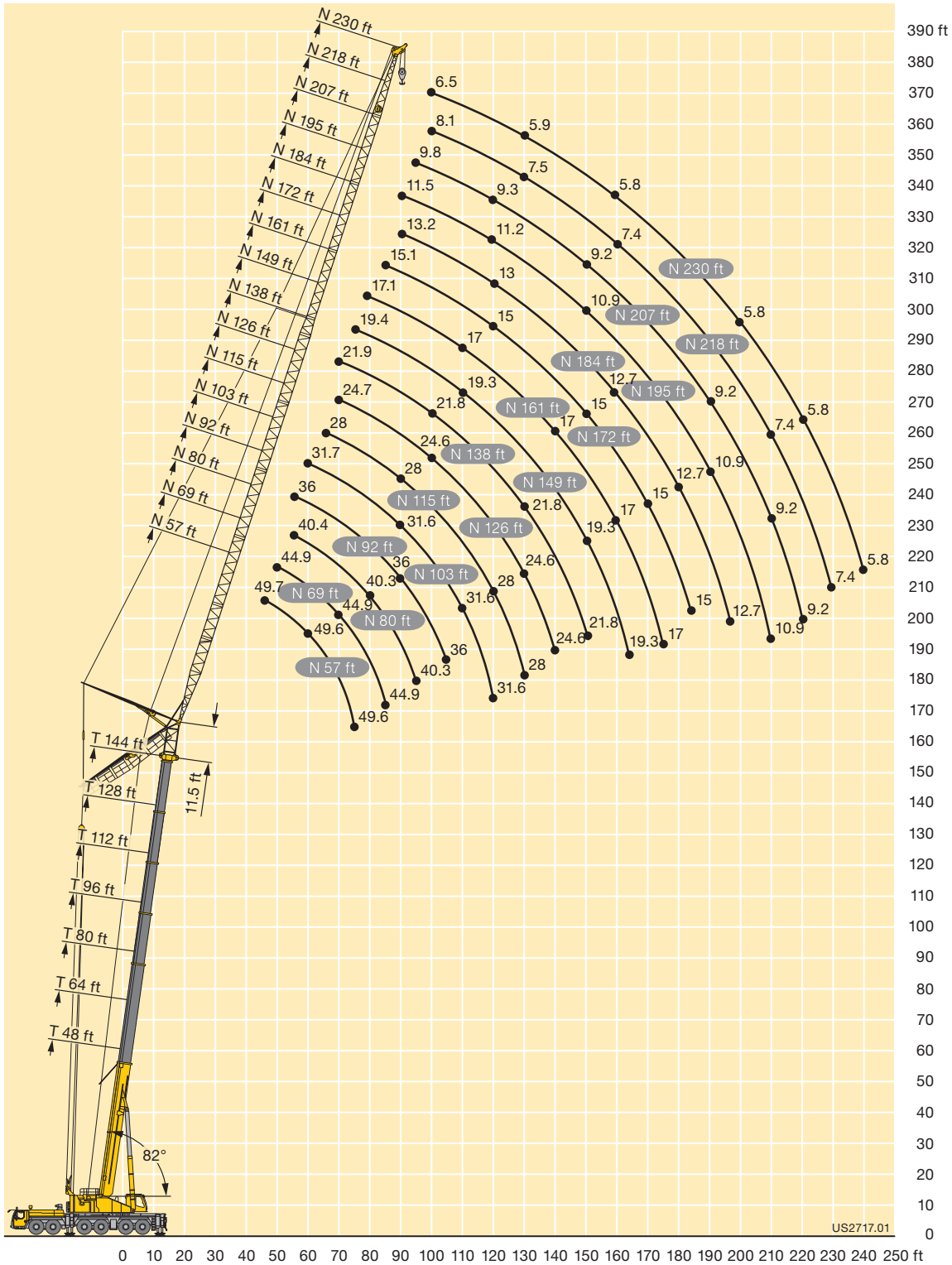

Equipment Equipment

Crane carrier

| | |
|--------------------------|--|
| Frame | Self-manufactured, torsion-resistant box-type design of high-tensile fine grained structural steel. |
| Outriggers | 4-point supporting system, hydraulically telescopic into horizontal and vertical direction. Operation with remote control, automatic support leveling, electronic inclination display. |
| Engine | 8-cylinder Diesel, make Liebherr, watercooled, output 450 kW (612 h.p.), max. torque 2107 lbs-ft. Exhaust emissions acc. to 97/68/EG and EPA/CARB. Fuel reservoir: 211 gallons. |
| Transmission | Automatic transmission system with torque converter and interarder, make ZF, type TC-TRONIC with 12 forward speeds and 2 reverse speeds, transfer case with transfer differential. |
| Axles | Low maintenance carrier axles, all 6 axles steered. Axle 1, 3 and 5 are equipped with planetary gears, all driven axles with transverse differential locks, axle 3 with longitudinal differential lock. |
| Cardan shaft | All cardan shafts with 70° diagonal toothing and maintenance free. |
| Suspension | All axles are hydro-pneumatically suspended with automatic leveling. Suspension hydraulically lockable. |
| Tyre equipment | 12 tyres, all axles equipped with single tyres. Size of tyres: 445/95 R 25 (16.00 R 25). |
| Steering | 2-circuit system with hydraulic servo steering. Active speed depending rear axle steering, special steering programs for various driving situations. |
| Brakes | Service brake: all-wheel servo-air brake, all axles are equipped with disc brakes, dual circuit. Additional brakes: exhaust flap brake, Telma Eddy current brake (optional), interarder in gearbox. Hand brake: Spring-loaded, acting on all wheels of axles 2 to 6. |
| Driver's cab | Spacious corrosion resistant with comfort furnishings, mounted on rubber shock absorbers, safety glazing. |
| Electrical system | Modern data bus technique, 24 Volt DC, 2 batteries of 170 Ah each. |

Crane superstructure

| | |
|------------------------|--|
| Frame | Liebherr-manufactured, torsionally rigid steel construction made from high-tensile fine-grain steel. Triple-roller slewing rim. |
| Crane drive | Mechanical drive of the crane hydraulic from the chassis. Variable axial piston pumps with servo control and power regulation. |
| Crane control | Two self-centering control levers (joy-sticks). Pedal switches for telescoping. Infinitely variable crane motions through displacement control of the hydraulic pumps. Additional working speed control by variation of the Diesel engine speed. |
| Hoist gear | Axial piston variable displacement motor, hoist drum with integrated planetary gear and spring-loaded static brake. Actuation by closed regulated oil circuit. |
| Luffing gear | 1 differential hydraulic ram with nonreturn valve. |
| Slewing gear | Axial piston fixed displacement motor, planetary gear, spring-loaded static brake. Actuation by closed regulated oil circuit. |
| Crane cab | Large screen area, compound glass, comfort furnishing, cabin tiltable 20° to rear. |
| Safety devices | LICCON2 safe load indicator, test system, hoist limit switches, safety valves against rupture of pipes and hoses. |
| Counterweight | 123500 lbs |
| Telescopic boom | 1 base section and 6 telescopic sections. All telescopic sections extendable individually by means of the rapid-cycle telescoping system TELEMATIK. Boom length 48 ft to 256 ft. |

Additional equipment

| | |
|---------------------------------|--|
| Swing-away jib K/NZK | 41 ft – 115 ft long, mountable to the telescopic boom at 0°, 20° or 40°, integrated erection jib of 18 ft (option). Hydraulic ram for operating the swing-away jib from 0° – 40° (option). |
| Lattice jibs F/N | Fixed lattice jib 46 ft – 138 ft long, at 0°, 20°, 40° (F), luffing lattice jib 57 ft – 230 ft m long (N). |
| Additional counterweight | 4 additional counterweight slabs of 22050 lbs each for a total counterweight of 211650 lbs. |
| 2nd hoist gear | For 2-hook operation or for operating the luffing lattice jib. |
| Tyre equipment | 12 tyres, size 525/80 R 25 (20.5 R 25). |
| Drive 12 x 8 | The 4th axle is driven additionally. |

Other items of equipment available on request.

Equipment Équipement

Châssis porteur

| | |
|--------------------------------|--|
| Châssis | Châssis résistant à la torsion de fabrication Liebherr, en acier à grains fins très résistant. |
| Stabilisateurs | Dispositif de calage horizontal et vertical en 4 points, entièrement déployable hydrauliquement. Utilisation avec commande à distance, mise à niveau automatique du calage, inclinomètre électronique. |
| Moteur | Moteur diesel, 8 cylindres, fabriqué par Liebherr, à refroidissement par eau, de 450 kW (612 ch), couple max. 2107 lbs-ft. Emissions des gaz d'échappement conformes aux directives 97/68/EG et EPA/CARB. Capacité du réservoir à carburant: 211 gallons. |
| Boîte de vitesse | Boîte automatique avec convertisseur de couple et ralentisseur, marque ZF, type TC-TRONIC avec 12 marches AV et 2 marches AR, boîte de transfert avec différentiel répartiteur. |
| Essieux | Essieux nécessitant peu d'entretien, les 6 essieux sont directeurs. Les essieux 1, 3 et 5 sont des essieux planétaires, tous les essieux moteurs avec différentiel transversal et l'essieu 3 avec différentiel longitudinal. |
| Arbres articulés | Tous les flasques de croisillons avec denture en croix 70° et sans entretien. |
| Suspension | Tous les essieux sont à suspension hydro-pneumatique avec mise à niveau automatique. Suspension blocable hydrauliquement. |
| Pneumatiques | 12 roues à monte simple. Taille: 445/95 R 25 (16.00 R 25). |
| Direction | 2 circuits avec direction assistée hydraulique. Direction active des essieux arrière et dépendante de la vitesse, programmes de direction spéciaux pour les différents modes de déplacement. |
| Freins | Freins de service: servofrein à air comprimé, tous les essieux sont munis de freins à disque, à 2 circuits. Freins auxiliaire : par clapet sur échappement, frein Telma (option), ralentisseur monté sur boîte de vitesse. Frein de secours et frein à main: par cylindres à ressorts sur les essieux 2 à 6. |
| Cabine | Spacieuse cabine, traitement anticorrosion, équipement «grand confort», suspension par silentblochs, vitrage de sécurité. |
| Installation électrique | Technique moderne de transmission de données par BUS de données, courant continu 24 Volts, 2 batteries de 170 Ah chacune. |

Partie tournante

| | |
|----------------------------|--|
| Châssis | Fabrication Liebherr, construction soudée indéformable, en acier à grain fin haute résistance. Couronne d'orientation à triple rangée de rouleaux. |
| Entraînement | Entraînement mécanique de l'hydraulique de la grue par le châssis de la grue. Pompes réglables à pistons axiaux avec servocommande et réglage de puissance. |
| Commande | 2 leviers à 4 directions avec rappel automatique au point mort. Commande des mouvements progressive en continu par variation de l'inclinaison des pompes et augmentation du régime moteur. |
| Treuil | Moteur hydraulique à cylindrée variable, treuil avec réducteur planétaire à frein d'arrêt à lamelles intégrées, en circuit hydraulique ferme. |
| Relevage de flèche | 1 vérin hydraulique différentiel avec clapet anti-retour de sécurité. |
| Orientation | Moteur à cylindrée constante à pistons axiaux, engrenage planétaire, frein d'arrêt commandé par ressort en circuit hydraulique ferme. |
| Cabine de grue | Large champ de vision, vitrage de sécurité, équipement pour un confort idéal, cabine inclinable de 20° vers l'arrière. |
| Sécurités | Contrôleur de charge LICCON2, système test, fin de course crochet haut, clapets de sécurité en cas de ruptures de flexibles. |
| Contrepoids | 123500 lbs |
| Flèche télescopique | Un élément de base et de 6 télescopes. Chaque partie peut être télescopée individuellement à l'aide du système de télescopage séquentiel rapide TELEMATIK. Longueur de flèche: 48 ft – 256 ft. |



















Équipement supplémentaire

| | |
|-----------------------------------|--|
| Flechette pliante K/NZK | Longueur: 41 ft – 115 ft, montable sous un angle de 0°, 20° ou 40°, flechette de montage intégrée de 18 ft de long (en option). Verin hydraulique pour le relevage de la flechette pliante de 0° à 40° (en option). |
| Flechettes F/N | Flechette treillis fixe 46 ft – 138 ft long, sous 0°, 20°, 40° (F), flechette treillis à volée variable 57 ft – 230 ft long (N). |
| Contrepoids complémentaire | 4 blocs latéraux de suspension de 22050 lbs pour un contrepoids total de 211650 lbs. |
| Deuxième treuil | Pour le travail avec 2 crochets ou le relevage de la fléchette à volée variable. |
| Pneumatiques | 12 pneus. Taille 525/80 R 25 (20.5 R 25). |
| Entraînement 12 x 8 | Le 4ème essieu est également entraîné. |





Autres équipements supplémentaires sur demande.

Description of symbols Explication des symboles

General symbols Symboles généraux

| | | | |
|---|---|---|--|
|  | Page Page |  | Driving speed Vitesse de translation |
|  | Outriggers Calage |  | Driving speed – Onroad gear Vitesse de translation – Vitesse de route |
|  | Axle Essieu |  | Transmission Boîte de vitesse |
|  | Radius Portée |  | Gear Vitesse |
|  | Boom length Longueur de la flèche |  | Hookblock / Capacity Moufle à crochet / Capacité de charge |
|  | Boom position Position de la flèche |  | Hoist gear Treuil de levage |
|  | Counterweight Contrepoids |  | Crane carrier Châssis porteur |
|  | Tyres Pneumatiques |  | Crane superstructure Partie tournante de la grue |
|  | Slewing gear / Working area Mécanisme d'orientation / Plage de travail |  | Gradability Aptitude à gravir les pentes |
|  | Standard Norme | | |

Crane specific symbols Symboles spécifiques à la grue

| | | | |
|---|---|---|--|
|  | Telescopic boom Flèche télescopique |  | Fixed lattice jib Fléchette treillis fixe |
|  | Mechanical swing away jib Fléchette pliante mécanique |  | Luffing fly jib Fléchette treillis à volée variable |
|  | Hydraulic swing away jib Fléchette pliante hydraulique | | |

Remarks referring to load charts

1. The lifting capacities do not exceed 85 % of the tipping load according to ASME B 30.5.
The crane's structural steelwork is in accordance with EN 13000 and ASME B 30.5.
2. For the calculation of the load charts at least a wind speed of 30 ft/s (9 m/s, 20 mph) and regarding the load a sail area of 1 m² per ton load and a wind resistance coefficient of 1.2 on the load have been taken into account. For lifting of loads with large sail areas and/or high wind resistance coefficients the maximum wind speed as stated in the load charts has to be reduced.
3. Lifting capacities are given in kips.
4. The weight of the hook blocks and hooks is part of the load and therefore it must be deducted from the lifting capacities.
5. Working radii are measured from the slewing centre.
6. The lifting capacities given for the telescopic boom apply if the folding jib is removed.
7. Subject to modification of lifting capacities.
8. Lifting capacities above 298600 lbs / 410000 lbs only with additional pulley block/special equipment.
9. The data of this brochure serves only for general information. All information is provided without warranty. Instructions for the correct commissioning of the crane please take from the operation manual and the load chart book.

Remarques relatives aux tableaux des charges

1. La capacité de charge ne doit pas dépasser 85 % de la charge de basculement conformément à ASME B 30.5.
La structure métallique de la grue est conforme à EN 13000 et ASME B 30.5.
2. Une vitesse de vent de 30 ft/s (9 m/s, 20 mph) minimum, une surface de prise au vent de 1 m² par tonne ainsi qu'un coefficient de résistance au vent de la charge 1,2 sont pris en compte pour le calcul des tableaux de charge. Lorsque des charges ayant une surface de prise au vent et/ou un coefficient de résistance au vent plus élevé(e)s sont levées, la vitesse de vent maximale indiquée dans les tableaux de charge doit être réduite.
3. Les charges sont indiquées en kips.
4. Le poids du crochet de levage resp. de la moufle à crochet est une partie de la charge et doit donc être déduit de la capacité de charge.
5. Les portées sont calculées à partir de l'axe de rotation.
6. Les charges indiquées pour la flèche télescopique sont valables lorsque la fléchette pliante est démontée.
7. Charges données sous réserve de modification.
8. Les charges supérieures à 298600 lbs / 410000 lbs seulement avec moufle additionnel/équipement supplémentaire.
9. Les données de cette brochure sont données à titre informatif. Ces renseignements sont sans garantie. Les consignes relatives à la bonne mise en service de la grue sont disponibles dans le manuel d'utilisation et le manuel de tableaux de charge.

Subject to modification / Sous réserve de modifications

Printed in Germany (3)

TD 240.01.US11.2014

Liebherr-Werk Ehingen GmbH

Postfach 1361, 89582 Ehingen, Germany

☎ +49 73 91 5 02-0, Fax +49 73 91 5 02-33 99

www.liebherr.com, E-mail: info.lwe@liebherr.com

www.facebook.com/LiebherrConstruction